



Product Zebra Technologies Corporation

Producer 333 Corporate Woods Parkway
Vernon Hills, IL 60061 U.S.A.

Product Description Model: TLP 3842 Thermal Transfer Printer

Hazardous Substances and Preparations This product may contain the following substances:

- Hexavalent Chromium may be present in trace amounts in the metal fasteners, brackets and other metal structural components.
- Lead may be present in the PCBAs used in this product.

Batteries Certain options of this product may contain a lithium-ion (Li-Ion) type battery located on the main control PCBA. This battery must be disposed of in accordance with local regulations.

Packaging The packaging materials used for this product do not contain any of the banned materials listed in the EU packaging directive.

The printed user documentation included with this product is produced on paper with 50% or more recycled content that has not been bleached with chlorine. If a Compact Disc (CD) is supplied, it is made from a recyclable polycarbonate material.

Information on the assessment of the packaging scheme for this or other Zebra products can be found at: <http://www.zebra.com/environment>.

Recycling Information Zebra Technologies offers product recycling programs in certain geographic areas. To determine if a program is available for this product in your area, please refer to our web site at: <http://www.zebra.com/environment>.

This product is designed with the following features to enhance recycling:

- Glues and adhesives have been eliminated from product construction where feasible.
- Use of common fasteners and/or snap-in features
- Plastic parts weighing more than 25g are marked according to ISO 11469 standards except where impractical. Exceptions are noted in the following drawing.



TLP 3842

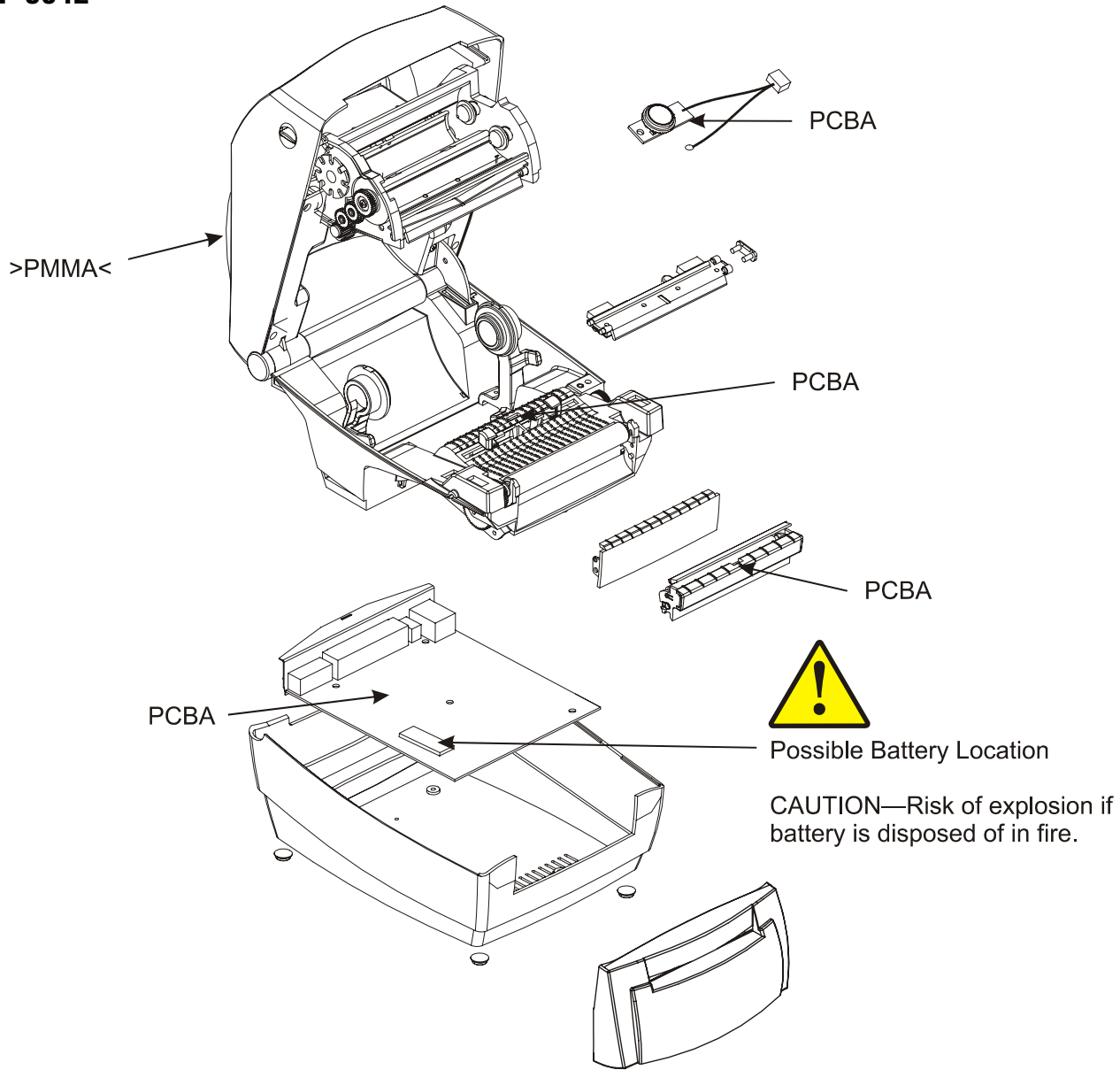

This document was compiled from information available at the time of publication and is issued only as an information source. No warranty as to accuracy or completeness is expressed or implied. This document is subject to change without notice.