

# MC3400/MC3450

Mobile Computer



**ZEBRA**

## Product Reference Guide

2024/10/31

ZEBRA and the stylized Zebra head are trademarks of Zebra Technologies Corporation, registered in many jurisdictions worldwide. All other trademarks are the property of their respective owners. ©2024 Zebra Technologies Corporation and/or its affiliates. All rights reserved.

Information in this document is subject to change without notice. The software described in this document is furnished under a license agreement or nondisclosure agreement. The software may be used or copied only in accordance with the terms of those agreements.

For further information regarding legal and proprietary statements, please go to:

SOFTWARE: [zebra.com/informationpolicy](https://zebra.com/informationpolicy).

COPYRIGHTS: [zebra.com/copyright](https://zebra.com/copyright).

PATENTS: [ip.zebra.com](https://ip.zebra.com).

WARRANTY: [zebra.com/warranty](https://zebra.com/warranty).

END USER LICENSE AGREEMENT: [zebra.com/eula](https://zebra.com/eula).

## Terms of Use

### Proprietary Statement

This manual contains proprietary information of Zebra Technologies Corporation and its subsidiaries ("Zebra Technologies"). It is intended solely for the information and use of parties operating and maintaining the equipment described herein. Such proprietary information may not be used, reproduced, or disclosed to any other parties for any other purpose without the express, written permission of Zebra Technologies.

### Product Improvements

Continuous improvement of products is a policy of Zebra Technologies. All specifications and designs are subject to change without notice.

### Liability Disclaimer

Zebra Technologies takes steps to ensure that its published Engineering specifications and manuals are correct; however, errors do occur. Zebra Technologies reserves the right to correct any such errors and disclaims liability resulting therefrom.

### Limitation of Liability

In no event shall Zebra Technologies or anyone else involved in the creation, production, or delivery of the accompanying product (including hardware and software) be liable for any damages whatsoever (including, without limitation, consequential damages including loss of business profits, business interruption, or loss of business information) arising out of the use of, the results of use of, or inability to use such product, even if Zebra Technologies has been advised of the possibility of such damages. Some jurisdictions do not allow the exclusion or limitation of incidental or consequential damages, so the above limitation or exclusion may not apply to you.

# Contents

<b>About This Guide.....</b>	<b>12</b>
Configurations.....	12
Notational Conventions.....	15
Icon Conventions.....	15
Service Information.....	15
Determining the Serial Number.....	16
Determining Software Versions.....	16
<b>Getting Started.....</b>	<b>17</b>
Unpacking the Device.....	17
Features.....	17
Gun Configuration.....	17
Straight Shooter Configuration.....	20
Setting Up the Device.....	22
Installing a microSD Card.....	22
Installing a SIM Card.....	25
Installing the Battery.....	28
Replacing the Battery.....	31
Charging the Device.....	34
<b>Using the Device.....</b>	<b>37</b>
Waking the Device.....	37
Home Screen.....	37
Setting Home Screen Rotation.....	39
Status Bar.....	39

Managing Notifications.....	42
Opening the Quick Access Panel.....	43
Battery Management.....	46
Checking Battery Status.....	47
Monitoring Battery Usage.....	47
Low Battery Notification.....	47
USB Communication.....	48
Transferring Files.....	48
Transferring Photos.....	48
Disconnecting from the Host Computer.....	48
Interactive Sensor Technology.....	49
<b>Settings.....</b>	<b>50</b>
Accessing Settings.....	50
Display Settings.....	50
Setting the Screen Brightness Manually.....	50
Setting Night Light.....	50
Setting Screen Rotation.....	51
Setting Screen Timeout.....	51
Setting the Date and Time.....	51
Setting Display and Text Sizes.....	52
Setting Touch Panel Mode.....	52
General Sound Setting.....	53
Remappable Keys.....	54
UI Listed Keys.....	54
Other Remappable Keys.....	54
Non-Remappable Keys.....	55
Language Usage.....	55
Changing the Language Setting.....	55
Adding Words to the Dictionary.....	56
Keyboards.....	56
Keyboard Configuration.....	56
Using the Android and Gboard Keyboards.....	57
Enterprise Keyboard.....	57

Notifications.....	58
Viewing Notifications.....	58
Controlling Lock Screen Notifications.....	58
Enabling Blink Light.....	58
<b>Applications.....</b>	<b>60</b>
Installed Applications.....	60
Accessing Settings.....	61
Switching Between Recent Apps.....	61
Battery Manager.....	61
Battery Manager Information Tab.....	62
Camera.....	64
Taking Photos.....	64
Recording Videos.....	66
Camera and Video Settings.....	68
DWDemo.....	69
DWDemo Icons.....	69
Rxlogger.....	70
RxLogger Configuration.....	70
Configuration File.....	70
Enabling Logging.....	71
Disabling Logging.....	71
Extracting Log Files.....	71
Backing Up Data.....	71
RxLogger Utility.....	71
<b>Data Capture.....</b>	<b>73</b>
Imaging.....	73
Operational Modes.....	74
Scanning Considerations.....	74
Scanning with the Internal Imager.....	75
Scanning with the RS5100 Ring Scanner.....	77
Scanning with the RS6000 Bluetooth Ring Scanner.....	79

Scanning with the DS3678 Bluetooth Scanner.....	81
Scanning with the DS2278 Digital Scanner.....	82
Scanning with the DS8178 Bluetooth Scanner.....	83
Scanning with the LI3678 Linear Imager.....	85
Pairing a Bluetooth Ring Scanner.....	86
Pairing in SSI Mode Using Near Field Communication.....	86
Pairing in HID Mode Using Near Field Communication.....	87
Pairing Using Simple Serial Interface (SSI).....	88
Pairing the Ring Scanner Using Bluetooth Human Interface Device.....	88
Pairing a Bluetooth Scanner.....	89
Pairing the Bluetooth Scanner Using Simple Serial Interface (SSI).....	89
Pairing Using Bluetooth Human Interface Device.....	90
DataWedge.....	91
Enabling DataWedge.....	91
Disabling DataWedge.....	91
Supported Decoders.....	92
Camera Supported Decoders.....	92
SE55 Internal Imager Supported Decoders.....	92
SE58 Internal Imager Supported Decoders.....	93
SE4710 Internal Imager Supported Decoders.....	94
SE4770 Internal Imager Supported Decoders.....	95
RS5100 Supported Decoders.....	96
RS6000 Supported Decoders.....	96
DS3678 Supported Decoders.....	97
DS2278 Supported Decoders.....	98
DS8178 Supported Decoders.....	99
LI3678 Supported Decoders.....	100
<b>Wireless.....</b>	<b>101</b>
Wireless Local Area Network.....	101
Removing a Wi-Fi Network.....	101
Connecting to a Wi-Fi Network.....	102
WLAN Configuration.....	102
Wireless Wide Area Networks.....	105

Sharing the Mobile Data Connection.....	105
Data Usage.....	107
Cellular Network Settings.....	108
Bluetooth.....	110
Adaptive Frequency Hopping.....	110
Security.....	111
Bluetooth Profiles.....	111
Bluetooth Power States.....	112
Bluetooth Radio Power.....	112
Discovering Bluetooth Device(s).....	113
Changing the Bluetooth Name.....	113
Connecting to a Bluetooth Device.....	113
Selecting Profiles on the Bluetooth Device.....	114
Unpairing a Bluetooth Device.....	114
Near Field Communications.....	114
Reading NFC Cards.....	115
Sharing Information Using NFC.....	115
Enterprise NFC Settings.....	116
Cast.....	117
<b>Accessories.....</b>	<b>118</b>
Battery Compatibility.....	121
Accessories for Charging.....	121
1-Slot USB Charge Cradle with Spare Battery Charger.....	122
5-Slot Charge Only ShareCradle.....	125
5-Slot Ethernet ShareCradle.....	126
5-Slot ShareCradle with 4-Slot Battery Charger.....	130
5-Slot Ethernet ShareCradle with 4-Slot Battery Charger.....	132
4-Slot Spare Battery Charger.....	136
20-Slot Spare Battery Charger.....	138
USB Connection.....	141
Charge Only Adapter.....	143
Rubber Boot.....	145
Installing the Rubber Boot on a Gun.....	145

Installing the Rubber Boot on a Straight Shooter.....	146
Hand Strap.....	147
Installing a Hand Strap on a Gun.....	147
Installing a Hand Strap on a Straight Shooter.....	148
Fabric Holster.....	150
Using a Gun Belt Strap.....	150
Using a Straight Shooter Belt Clip.....	152
Using a Shoulder Strap.....	153
Rigid Holster.....	154
Attaching the Rigid Holster.....	154
Un-Powered Forklift Mount.....	156
Installing the Device in a Forklift Mount.....	156
<b>Application Deployment.....</b>	<b>158</b>
Security.....	158
Secure Certificates.....	158
Installing a Secure Certificate.....	159
Configuring Credential Storage Settings.....	159
Android Development Tools.....	159
Android Development Workstation.....	159
Enabling Developer Options.....	160
EMDK for Android.....	160
StageNow for Android.....	160
GMS Restricted.....	160
ADB USB Setup.....	161
Application Installation Methods.....	162
Installing Applications Using the USB Connection.....	162
Installing Applications Using the Android Debug Bridge.....	163
Installing Applications Using Wireless ADB.....	163
Installing Applications Using a microSD Card.....	164
Uninstalling an Application.....	165
Android System Update.....	166
Performing a System Update Using a microSD Card.....	166
Performing a System Update Using ADB.....	166



Verifying System Update Installation.....	167
Android Enterprise Reset.....	167
Performing an Enterprise Reset From Device Settings.....	167
Performing an Enterprise Reset Using a microSD Card.....	168
Performing an Enterprise Reset Using ADB.....	168
Android Factory Reset.....	169
Performing a Factory Reset Using a microSD Card.....	169
Performing a Factory Reset Using ADB.....	170
Android Storage.....	170
Random Access Memory.....	170
Internal Storage.....	171
External Storage.....	171
Managing Apps.....	172
App Details.....	173
Managing Downloads.....	173
<b>Keypads.....</b>	<b>174</b>
29-Key Keypad.....	174
29-Key Keypad Input Modes.....	176
38-Key Keypad.....	177
38-Key Keypad Input Modes.....	179
47-Key Keypad.....	181
47-Key Keypad Input Modes.....	183
<b>Maintenance and Troubleshooting.....</b>	<b>185</b>
Maintaining the Device.....	185
Battery Safety Guidelines.....	186
Cleaning Instructions.....	186
Approved Cleanser Active Ingredients.....	187
Harmful Ingredients.....	187
Device Cleaning Instructions.....	187
Special Cleaning Notes.....	187
Cleaning Materials Required.....	188

Cleaning Frequency.....	188
Cleaning the Device.....	188
Housing.....	188
Display.....	188
Camera and Exit Window.....	188
Cleaning Battery Connectors.....	188
Cleaning Cradle Connectors.....	189
Troubleshooting.....	189
Resetting the Device.....	189
Troubleshooting the Device.....	190
1-Slot USB Charge Cradle Troubleshooting.....	191
5-Slot Charge Only ShareCradle Troubleshooting.....	192
5-Slot Ethernet ShareCradle Troubleshooting.....	193
5-Slot Charge Only ShareCradle with 4-Slot Battery Charger Troubleshooting.....	194
5-Slot Ethernet ShareCradle with 4-Slot Battery Charger Troubleshooting.....	194
4-Slot Spare Battery Charger Troubleshooting.....	195
20-Slot Spare Battery Charger Troubleshooting.....	196
USB Charge Cable Troubleshooting.....	196
<b>Specifications.....</b>	<b>198</b>
Data Capture Supported Symbologies.....	198
SE4710 Decode Zones.....	198
SE4770 Decode Zones.....	199
SE55-AR Decode Zones.....	199
SE58-ER Decode Zones.....	200
Accessory Specifications.....	201
Connector Pin-Out.....	201
1-Slot USB Charge Cradle with Spare Battery Charger Technical Specifications.....	201
5-Slot Charge Only ShareCradle Technical Specifications.....	202
5-Slot Ethernet ShareCradle Technical Specifications.....	202
5-Slot Charge ShareCradle with 4-Slot Battery Charger Technical Specifications...	203
5-Slot Ethernet ShareCradle with 4-Slot Battery Charger Technical Specifications.....	203
4-Slot Spare Battery Charger Technical Specifications.....	204

20-Slot Spare Battery Charger Technical Specifications..... 204  
USB Charge Cable Technical Specifications.....205

# About This Guide

This guide provides information about setting up and using the MC3400/MC3450 mobile computer. Some screens shown in this guide may differ from the actual screens shown on the device.

## Configurations

This section covers the MC3400 and MC3450 configurations.



**NOTE:** All configurations run on Android-based, Google™ Mobile Services (GMS).

**Table 1** MC3400 Configurations

Radios	Display	Memory	Data Capture Options	Camera
<b>MC3400/Standard Tier</b>				
WLAN: IEEE 802.11 a/b/g/n/ac/ax/d/h/i/r/k/v/w/mc 2x2 MU-MIMO; Tri-band (2.4 GHz, 5 GHz, 6 GHz); Wi-Fi Certified 6™ (Wi-Fi 6E); Dual Band Simultaneous; IPv4, IPv6 WPAN: Class 1/Class 2, Bluetooth Low Energy (BLE) v5.3	4.0" WVGA (800 x 480) Color, 350 NITS	4 GB RAM 64 GB Flash	SE4710 1D/2D SE55 Advanced Range	No
<b>MC3400/Expanded Tier</b>				
WLAN: IEEE 802.11 a/b/g/n/ac/ax/d/h/i/r/k/v/w/mc 2x2 MU-MIMO; Tri-band (2.4 GHz, 5 GHz, 6 GHz); Wi-Fi Certified 6™ (Wi-Fi 6E); Dual Band Simultaneous; IPv4, IPv6 WPAN: Class 1/Class 2, Bluetooth Low Energy (BLE) v5.3	4.0" WVGA (800 x 480) Color, 600 NITS	6 GB RAM 64 GB Flash	SE4770 1D/2D SE55 Advanced Range SE58 1D/2D Extended Range	No
<b>MC3400/Full Featured Tier</b>				

**Table 1** MC3400 Configurations (Continued)

Radios	Display	Memory	Data Capture Options	Camera
WLAN: IEEE 802.11 a/b/g/n/ac/ax/d/h/i/r/k/v/w/mc 2x2 MU-MIMO; Tri-band (2.4 GHz, 5 GHz, 6 GHz); Wi-Fi Certified 6™ (Wi-Fi 6E); Dual Band Simultaneous; IPv4, IPv6 WPAN: Class 1/Class 2, Bluetooth Low Energy (BLE) v5.3	4.0" WVGA (800 x 480) Color, 600 NITS	6 GB RAM 128 GB Flash	SE4770 1D/2D SE55 Advanced Range SE58 1D/2D Extended Range	Yes

**Table 2** MC3450 Configurations

Radios	Display	Memory	Data Capture Options	Camera
<b>MC3450/Expanded Tier</b>				
WLAN: IEEE 802.11 a/b/g/n/ac/ax/d/h/i/r/k/v/w/mc 2x2 MU-MIMO; Tri-band (2.4 GHz, 5 GHz, 6 GHz); Wi-Fi Certified 6™ (Wi-Fi 6E); Dual Band Simultaneous; IPv4, IPv6 WPAN: Class 1/Class 2, Bluetooth Low Energy (BLE) v5.3 WWAN: 3G NA: B2/4/5 3G RoW: 1/2/4/5/8 4G NA: B2/4/5/7/8/12/13/14/17/25/26/29/30/38/41/48/66/71 4G RoW: B1/2/3/4/5/6/7/9/10/14/17/18/20/26/28/38/39/40/41/42/43/66/71 5G FR1 NA: n2/5/7/8/12/13/14/25/26/30/38/41/48/66/71/77/78 5G FR1 RoW: n1/2/3/5/7/8/12/18/20/26/28/38/40/41/66/71/77/78 Supports private networking (LTE/5G)	4.0" WVGA (800 x 480) Color, 600 NITS	6 GB RAM 64 GB Flash	SE4770 1D/2D SE55 Advanced Range SE58 1D/2D Extended Range	No
<b>MC3450/Full Featured Tier</b>				

**Table 2** MC3450 Configurations (Continued)

Radios	Display	Memory	Data Capture Options	Camera
<p>WLAN: IEEE 802.11 a/b/g/n/ac/ax/d/h/i/r/k/v/w/mc</p> <p>2x2 MU-MIMO; Tri-band (2.4 GHz, 5 GHz, 6 GHz); Wi-Fi Certified 6™ (Wi-Fi 6E); Dual Band Simultaneous; IPv4, IPv6</p> <p>WPAN: Class 1/Class 2, Bluetooth Low Energy (BLE) v5.3</p> <p>WWAN:</p> <p>3G NA: B2/4/5</p> <p>3G RoW: 1/2/4/5/8</p> <p>3G China/Japan: B1/5/6/8</p> <p>4G NA: B2/4/5/7/8/12/13/14/17/25/26/29/30/38/41/48/66/71</p> <p>4G RoW: B1/2/3/4/5/6/7/9/10/14/17/18/20/26/28/38/39/40/41/42/43/66/71</p> <p>4G China/Japan: B1/3/5/7/8/28/34/38/39/40/41/42</p> <p>5G FR1 NA: n2/5/7/8/12/13/14/25/26/30/38/41/48/66/71/77/78</p> <p>5G FR1 RoW: n1/2/3/5/7/8/12/18/20/26/28/38/40/41/66/71/77/78</p> <p>5G FR1 China/Japan: n1/3/5/7/8/28/38/40/ 41/77/78/79</p> <p>Supports private networking (LTE/5G)</p>	<p>4.0" WVGA (800 x 480) Color, 600 NITS</p>	<p>6 GB RAM</p> <p>128 GB Flash</p>	<p>SE4770 1D/2D</p> <p>SE55 Advanced Range</p> <p>SE58 1D/2D Extended Range</p>	<p>Yes</p>

## Notational Conventions

The following notational conventions make the content of this document easy to navigate.

- **Bold** text is used to highlight the following:
  - Dialog box, window, and screen names
  - Dropdown list and list box names
  - Checkbox and radio button names
  - Icons on a screen
  - Key names on a keypad
  - Button names on a screen
- Bullets (•) indicate:
  - Action items
  - List of alternatives
  - Lists of required steps that are not necessarily sequential.
- Sequential lists (for example, those that describe step-by-step procedures) appear as numbered lists.

## Icon Conventions

The documentation set is designed to give the reader more visual clues. The following visual indicators are used throughout the documentation set.



**NOTE:** The text here indicates information that is supplemental for the user to know and that is not required to complete a task.



**IMPORTANT:** The text here indicates information that is important for the user to know.



**CAUTION:** If the precaution is not heeded, the user could receive a minor or moderate injury.



**WARNING:** If danger is not avoided, the user CAN be seriously injured or killed.



**DANGER:** If danger is not avoided, the user WILL be seriously injured or killed.

## Service Information

If you have a problem with your equipment, contact Zebra Global Customer Support for your region. Contact information is available at: [zebra.com/support](http://zebra.com/support).

When contacting support, please have the following information available:

- Serial number of the unit
- Model number or product name
- Software type and version number

Zebra responds to calls by email, telephone, or fax within the time limits set forth in support agreements.

If your problem cannot be solved by Zebra Customer Support, you may need to return your equipment for servicing and will be given specific directions. Zebra is not responsible for any damages incurred during shipment if the approved shipping container is not used. Shipping the units improperly can possibly void the warranty.

If you purchased your Zebra business product from a Zebra business partner, contact that business partner for support.

## Determining the Serial Number

The serial number is an alphanumeric code assigned to a device for tracking and identification purposes.

Before contacting customer support, determine the serial number of your device.

1. Swipe down from the Status bar to open the Quick Access panel, and then touch .
2. Touch **Model**.  
The **Serial number** displays.

## Determining Software Versions

The software versions identify the specific release or iteration of a software application.

Before contacting customer support, determine the current software version on your device.

1. Swipe down from the Status bar to open the Quick Access panel, and then touch .
2. Touch **About phone > Android version**.
3. Scroll to view the following information:
  - **Android version:** Displays the latest Operating System (OS) version.
  - **Android security update:** Displays the date of the recent security update.
  - **Kernel version**
  - **Build number**



# Getting Started

This section provides information to get the device up and running for the first time.

## Unpacking the Device

Follow these steps when unpacking the device for the first time.

1. Carefully remove all protective material from the device and save the shipping container for later storage and shipping.
2. Verify that the following items are in the box:
  - Mobile computer
  - Hand-strap (only with Straight Shooter configuration)
  - Lithium-ion battery
  - Regulatory guide
3. Inspect the equipment for damage. If any equipment is missing or damaged, contact the Global Customer Support Center immediately.
4. Before using the device for the first time, remove the protective shipping films that cover the scan window, display, and camera window.

## Features

This section lists the features of the MC3400/MC3450 mobile computer.

### Gun Configuration

This section lists the features of the MC34 gun configuration.



**NOTE:** The front/rear camera and camera flash are available only in Full Featured configurations, and the ambient light sensor is available only in Expanded and Full Featured configurations.

**Figure 1** Top View

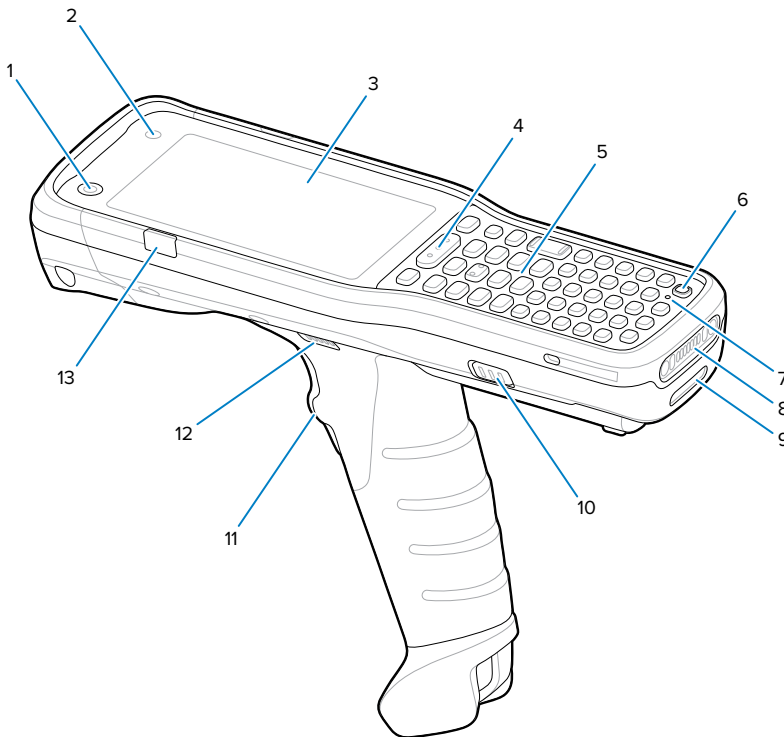

Number	Item	Description
1	5 MP front-facing camera	Take photos and videos. It is also used with Identity Guardian for facial biometrics authentication for Single Sign On (SSO).
2	Ambient light sensor	Determines ambient light for controlling display backlight intensity.
3	Display	Displays all information needed to operate the device.
4	Scan button	Initiates data capture when a scan application is enabled.
5	Keypad	Use to enter data and navigate on screen functions.
6	Power key	Press to turn on/off the display. Press and hold to select one of these options: <ul style="list-style-type: none"> <li>• <b>Power off</b> - Turn off the device.</li> <li>• <b>Restart</b> - Restart the device when the software stops responding.</li> </ul>
7	Microphone	Use for voice communications.
8	Charging I/O	Power/ground for charging and communication.
9	Hand strap slot	Attachment point for the hand strap.
10	Battery release latches	Releases the battery from the device.
11	Trigger	Initiates data capture when a scan application is enabled.
12	Speaker	Provides audio output for video and music playback.

Number	Item	Description
13	Charge/ Application notification LED or scan/decode status	Indicates the battery charge state while charging, an application notification was received, or the scan/decode status.

**Figure 2** Bottom View

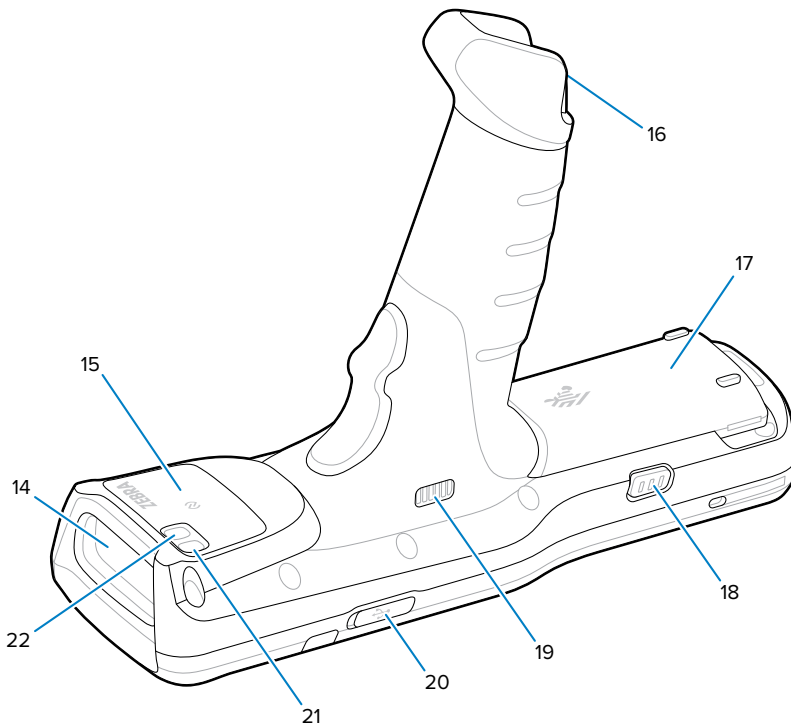

Number	Item	Description
14	Scanner exit window	Provides data capture using integrated imager option.
15	NFC antenna	Provides communication with other NFC-enabled devices.
16	Hand strap slot	Attachment point for the hand strap.
17	Battery	Provides power for operating the device.
18	Battery release latch	Releases the battery from the device.
19	Speaker	Provides audio output for video and music playback.
20	USB-C cover/ connector	Provides power and communications to the device using an I/O USB-C interface.
21	13 MP rear-facing camera	Take photos and videos.
22	Camera flash	Provides illumination for the camera.

## Straight Shooter Configuration

This section lists the features of the MC34 straight shooter configuration.



**NOTE:** The front/rear camera and camera flash are available only in Full Featured configurations, and the ambient light sensor is available only in Expanded and Full Featured configurations.

**Figure 3** Top View

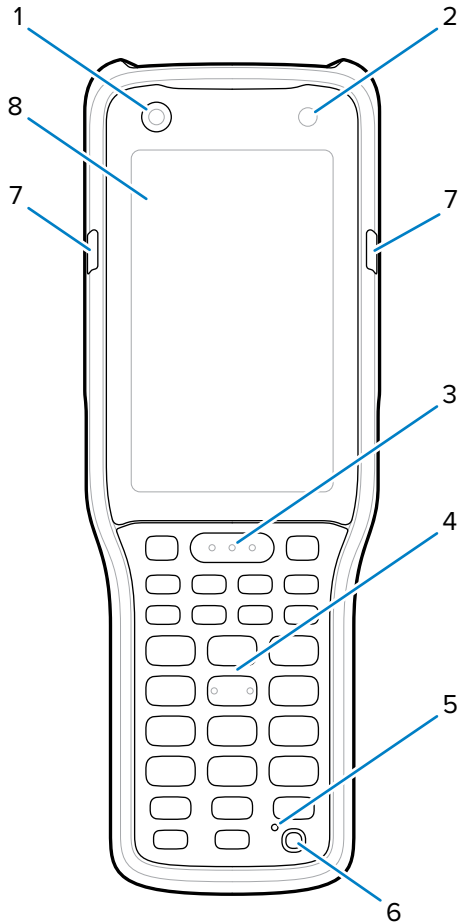

Number	Item	Description
1	5 MP front-facing camera	Take photos and videos. It is also used with Identity Guardian for facial biometrics authentication for Single Sign On (SSO).
2	Ambient light sensor	Determines ambient light for controlling display backlight intensity.
3	Scan button	Initiates data capture when a scan application is enabled.
4	Keypad	Use to enter data and navigate on screen functions.
5	Microphone	Use for voice communications.

## Getting Started

Number	Item	Description
6	Power key	Press to turn on/off the device. Press and hold to select one of these options: <ul style="list-style-type: none"> <li>• <b>Power off</b> - Turn off the device.</li> <li>• <b>Restart</b> - Restart the device when the software stops responding.</li> </ul>
7	Charge/ Application notification LED or scan/decode status	Indicates the battery charge state while charging, an application notification was received, or the scan/decode status.
8	Display	Displays all information needed to operate the device.

**Figure 4** Bottom View

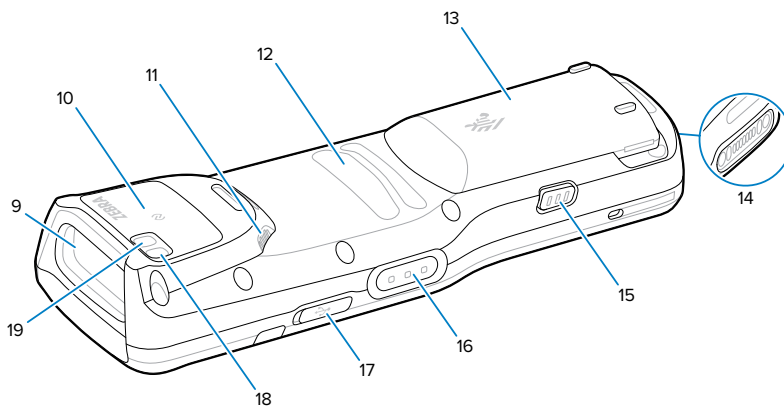

Number	Item	Description
9	Scanner exit window	Provides data capture using integrated imager option.
10	NFC antenna	Provides communication with other NFC-enabled devices.
11	Speaker	Provides audio output for video and music playback.
12	Finger perch	Provides grip of fingers on the device.
13	Battery	Provides power for operating the device.
14	Charging I/O	Power/ground for charging and communication.
15	Battery release latches	Releases the battery from the device.
16	Side key scan button	Initiates data capture when a scan application is enabled.
17	USB-C cover/ connector	Provides power and communications to the device using an I/O USB-C interface.
18	13 MP rear-facing camera	Take photos and videos.
19	Camera flash	Provides illumination for the camera.

### Setting Up the Device

To start using the device for the first time, you must set it up.

1. Install a nano SIM card (optional).
2. Install a microSD card (optional).
3. Install the battery.
4. Charge the device.
5. Power on the device.

### Installing a microSD Card

The microSD card slot (located under the battery pack) provides secondary, non-volatile storage. For more information, refer to the documentation provided with the microSD card and follow the manufacturer's recommendations for use. It is strongly recommended that you format the microSD card on the device before use.



**CAUTION:** Follow proper electrostatic discharge (ESD) precautions to avoid damaging the microSD card. Proper ESD precautions include, but are not limited to, working on an ESD mat and ensuring that the operator is properly grounded.

**1. Remove the battery:**

- a)** Push in the two battery release buttons.

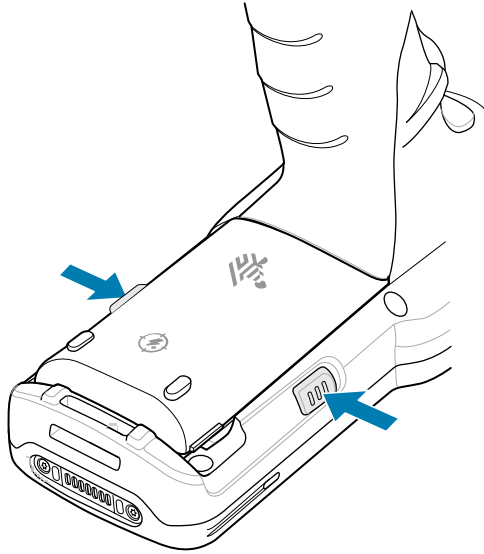

The battery ejects slightly.

- b)** Remove the battery from the compartment.

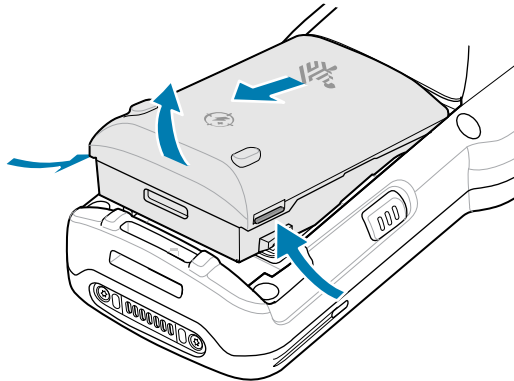

**2. Using a coin or finger, remove the access cover.**

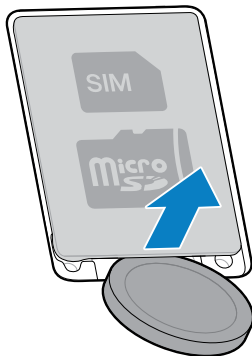

3. Slide the microSD card holder to the Open position.

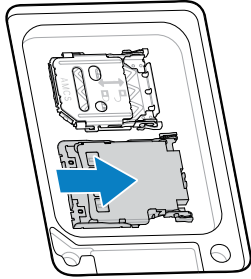

4. Lift the microSD card holder.

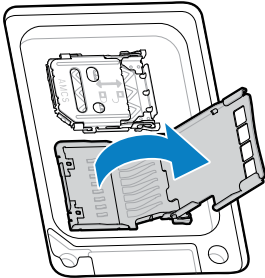

5. Insert the microSD card into the contact area with the contacts facing down.

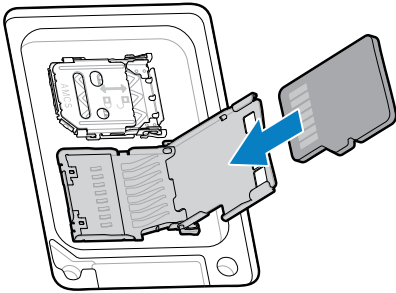

6. Close and slide the microSD card holder to the Lock position.

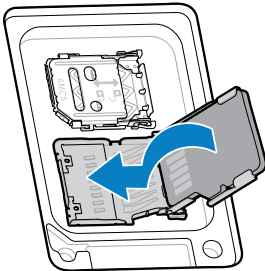



7. Re-install the access cover.

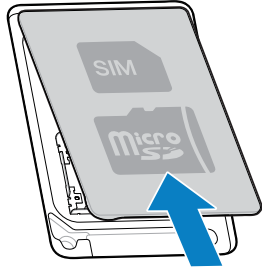

8. Re-install the battery.

### Installing a SIM Card

A SIM card or eSIM is required to make calls and transfer data over a cellular network with the MC3450. The SIM card slot is located under the battery pack.

The device also offers Dual SIM/Dual Standby (DSDS), which allows users to use both an eSIM and SIM card and remain on standby at any time.



**CAUTION:** Follow proper electrostatic discharge (ESD) precautions to avoid damaging the SIM card. Proper ESD precautions include but are not limited to, working on an ESD mat and ensuring the operator is properly grounded.

**1. Remove the battery:**

- a) Push in the two battery release buttons.**

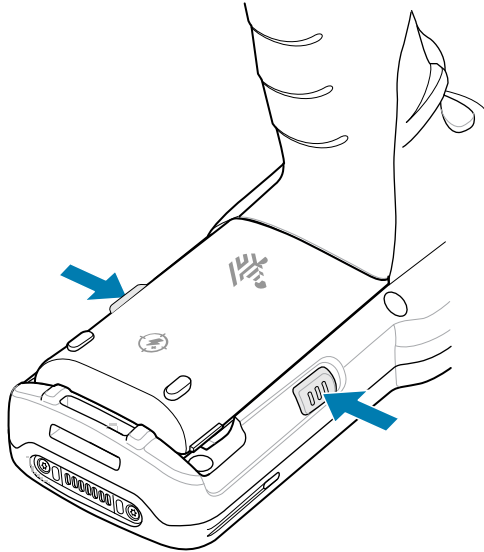

The battery ejects slightly.

- b) Remove the battery from the compartment.**

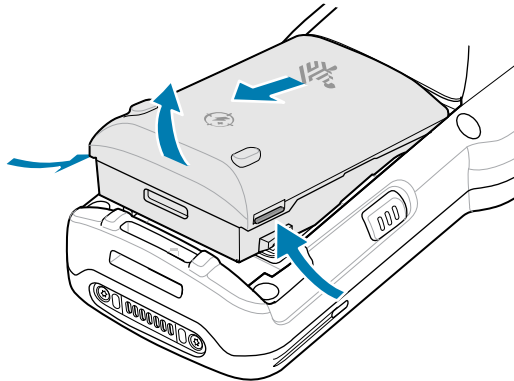

**2. Using a coin or finger, remove the access cover.**

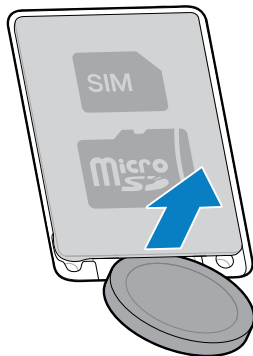

3. Slide the SIM cardholder to the right to unlock it.

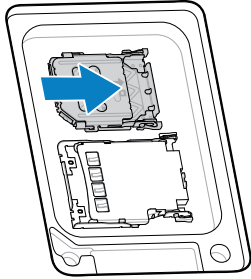

4. Lift the SIM card holder door.

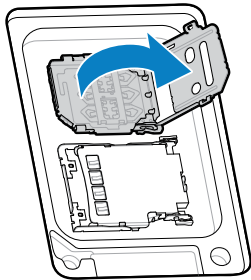

5. Place the SIM card into the cardholder with the contacts facing down.

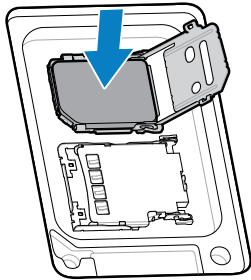

6. Close the SIM card holder door.

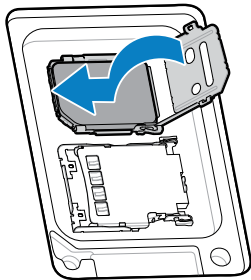

7. Slide the SIM card holder to the left to lock it.

8. Re-install the access cover.

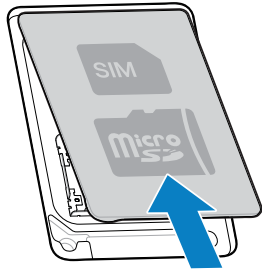

9. Re-install the battery.

### Installing the Battery

This section describes installing the battery for both gun and straight shooter configurations.

The device will not turn on if the battery voltage drops below 3.45 volts. To check the current battery voltage, go to [Battery Manager](#).

#### Installing the Gun Battery

The device is shipped with the 7,000 mAh PowerPrecision+ battery. The MC34 rechargeable Li-Ion battery with BLE beacon is available as an option.

1. Loosen the hand strap, if needed.
2. Align the battery into the battery compartment.

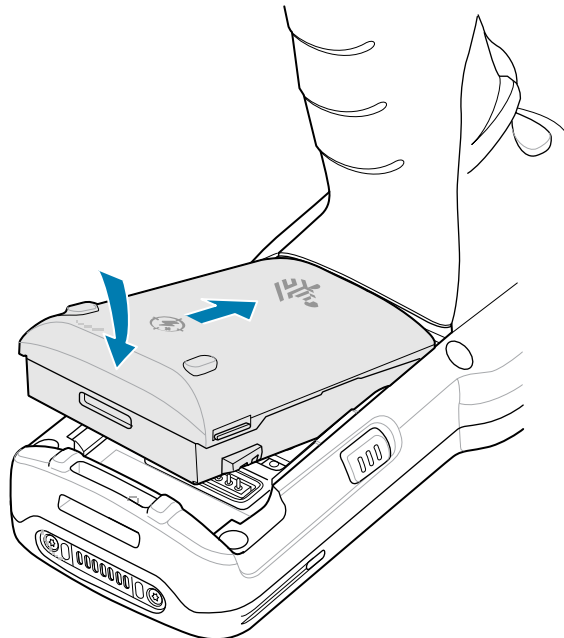

3. Slide the front of the battery into the battery compartment.

4. Press the battery down firmly. Ensure that both battery release buttons on the sides of the device return to the home position.

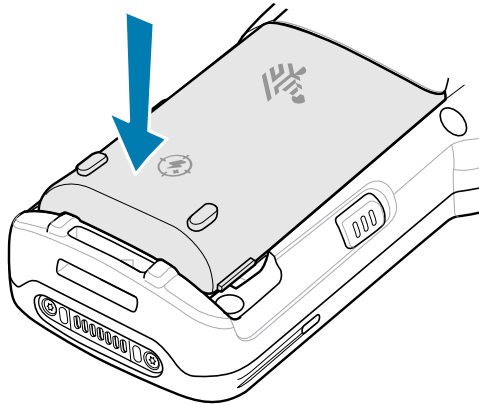

5. Tighten the hand strap if installed.
6. Press and hold the Power key (until you see a Zebra splash screen) to turn on the device.

### Installing the Straight Shooter Battery

The device is shipped with the 7,000 mAh PowerPrecision+ battery. The MC34 rechargeable Li-Ion battery with BLE beacon is available as an option.

1. Loosen the hand strap if needed.
2. Align the top of the battery into the battery compartment.

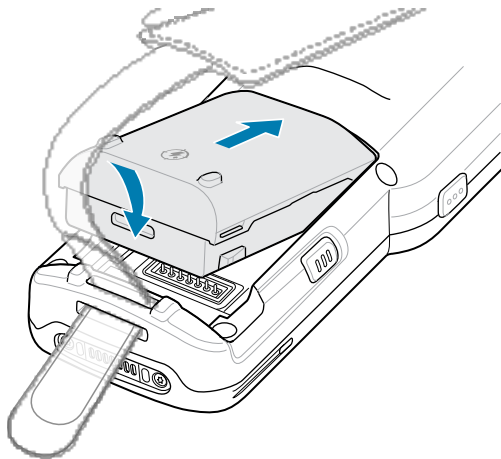

3. Slide the front of the battery into the battery compartment.

4. Press the battery down firmly.

Ensure that both battery release buttons on the sides return to the home position.

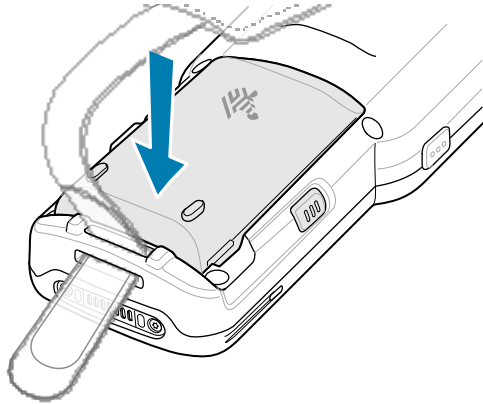

5. Tighten the hand strap if needed.
6. Press and hold the Power key (until you see a Zebra splash screen) to turn on the device.

### Rechargeable Li-Ion Battery with BLE Beacon

The rechargeable Li-Ion battery with BLE beacon is a 7,000 mAh PowerPrecision+ battery with a BLE beacon that allows users to track lost and powered-off devices. The device ships with a 7,000 mAh PowerPrecision+ battery. A rechargeable Li-Ion battery with BLE beacon is an available option.



**NOTE:** The Secondary BLE beaconing functions only if the rechargeable Li-Ion battery with BLE beacon is in the device before it is powered off.

**Figure 5** Rechargeable Li-Ion Battery with BLE Beacon with a Bluetooth Logo



The Secondary BLE settings are controlled by the operating system of the device. For more information on configuring the Secondary BLE settings, see [techdocs.zebra.com/emdk-for-android/13-0/mx/beaconmgr/](https://techdocs.zebra.com/emdk-for-android/13-0/mx/beaconmgr/).



**IMPORTANT:** Power on the device after installing the rechargeable Li-Ion battery with BLE beacon to ensure the operating system transfers the Secondary BLE settings to the battery.

For the rechargeable Li-Ion battery with BLE to work properly:

- It transmits a Bluetooth signal (beacon) only when the device is powered off or in Airplane mode (disabled by default).
- It must be in the device for the rechargeable Li-Ion battery with BLE beacon to transmit a signal (beacon).
- It transmits a BLE signal for at least seven days after the device is powered off due to battery depletion.

## Replacing the Battery

This section describes replacing the battery for both gun and straight shooter configurations.

### Replacing the Gun Battery

This section describes replacing the battery in the gun configuration.

1. Loosen the hand strap if needed.
2. Push in the two battery release buttons.

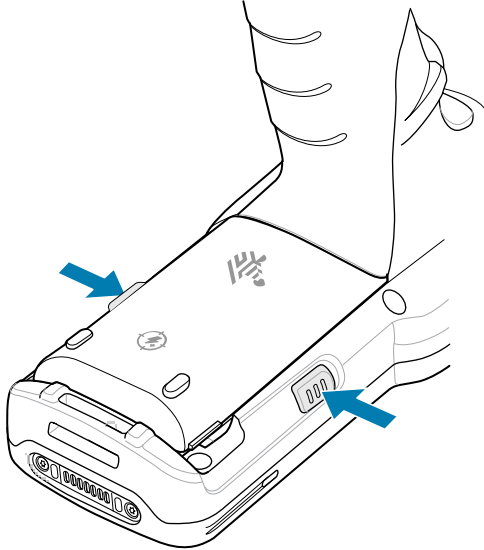

The battery ejects slightly.



**NOTE:** With Hot Swap mode, when you remove the battery, the display turns off, and the device enters a low-power state. The MC34 supports wireless connectivity persistence for 30 seconds (indicated by flashing amber LEDs), followed by RAM data persistence for approximately five minutes. Replace the battery within five minutes to preserve memory persistence.

3. Remove the battery from the battery compartment.

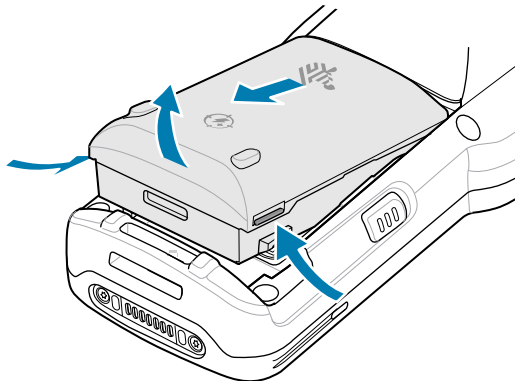

4. To install the battery, align the battery into the battery compartment.

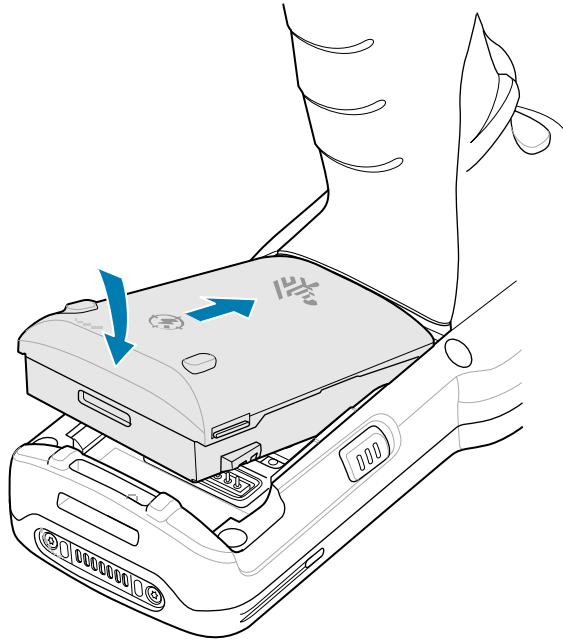

5. Slide the front of the battery into the battery compartment.
6. Press the battery down firmly.

Ensure that both the buttons on the sides of the device return to the home position.

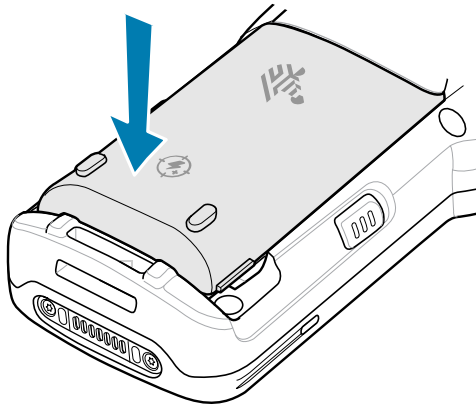

The device automatically resumes after battery removal and installation (in a Hot Swap change). The only time the Power key needs to be pressed is if the device has been powered off or left for a prolonged duration without a battery pack.

### Replacing the Straight Shooter Battery

This section describes replacing the battery in the straight shooter configuration.

1. Loosen the hand strap if needed.



2. Push in the two battery release buttons.

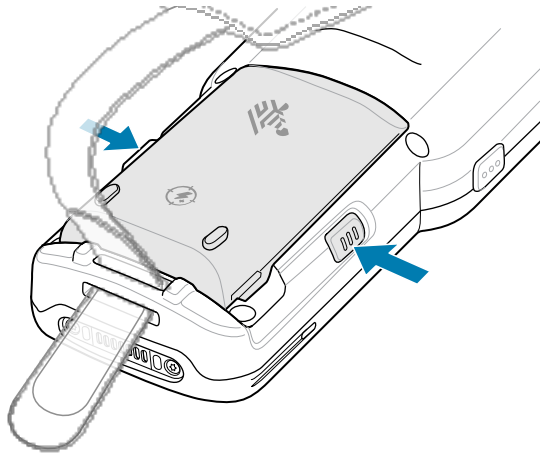

The battery ejects slightly.



**NOTE:** With Hot Swap mode, when you remove the battery, the display turns off, and the device enters a low-power state. The MC34 supports wireless connectivity persistence for 30 seconds (indicated by flashing amber LEDs), followed by RAM data persistence for approximately five minutes. Replace the battery within five minutes to preserve memory persistence.

3. Remove the battery from the battery compartment.

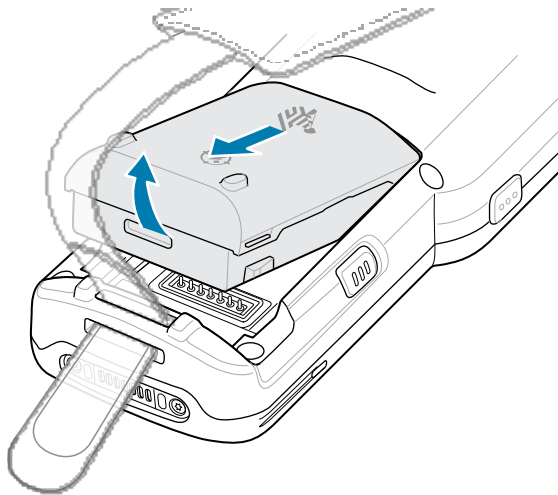

4. To install the battery, align the battery into the battery compartment.

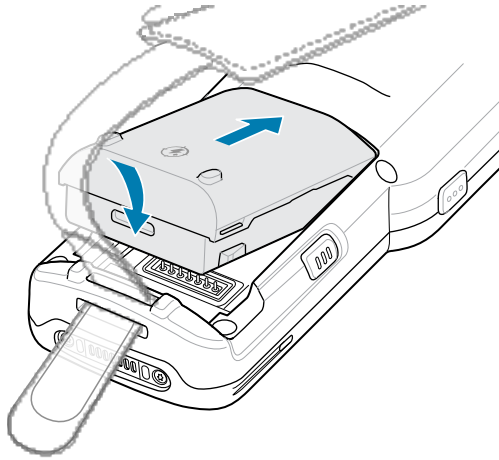

5. Slide the front of the battery into the battery compartment.
6. Press the battery down firmly.

Ensure that both the buttons on the sides of the device return to the home position.

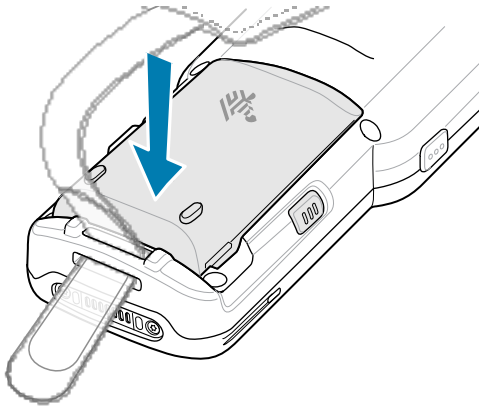

The device automatically resumes after battery removal and installation (in a Hot Swap change). The only time the Power key needs to be pressed is if the device has been powered off or left for a prolonged duration without a battery pack.

## Charging the Device

To achieve optimal charging results, use only Zebra charging accessories and batteries and charge batteries at room temperature.

A standard battery charges from fully depleted to 90% in approximately four hours and from fully depleted to 100% in approximately five hours. In many cases, a 90% charge provides enough charge for daily use. Depending on the usage profile, a full 100% charge may last for approximately 20 hours of use.



**NOTE:** Ensure that you follow the guidelines for battery safety in [Battery Safety Guidelines](#).

The device or accessory always performs battery charging in a safe and intelligent manner and indicates when charging is disabled due to abnormal temperatures via its LED, and a notification appears on the device display.

Temperature	Battery Charging Behavior
0°C to 45°C (32°F to 113°F)	Optimal charging range.
Below 0°C (32°F) Above 45°C (113°F)	Charging stops.
Above 58°C (136°F)	The device shuts down.

To charge the main battery:

1. Connect the charging accessory to the appropriate power source.
2. Insert the device into a charging cradle slot or connect a USB-C cable to the power source.  
The device turns on and begins charging. The charging/notification LED indicates the battery charging status.
3. When charging is complete, remove the device from the cradle slot or unplug the USB-C cable.

## Charging the Spare Battery

To achieve optimal charging results, use only Zebra charging accessories and batteries.

1. Connect the charger to a power source.
2. Insert the battery into a spare battery charging slot and gently press down on the battery to ensure proper contact.  
The spare battery charging LEDs on the front of the cradle indicate the spare battery charging status.
3. Remove the battery from the charging slot when charging is complete.

## Charging Indicators

The Charge LED Indicator indicates the charge status.

**Table 3** LED Charge Indicators

Status	Indications
Off	<ul style="list-style-type: none"> <li>The battery is not charging.</li> <li>The device is not inserted correctly in the cradle or connected to a power source.</li> <li>The device is not powered.</li> </ul>
Blinking Amber	Active wireless connectivity session during battery hot swap.
Solid Amber	Battery is charging.
Solid Green	Battery charging is complete.

**Table 3** LED Charge Indicators (Continued)

Status	Indications
Fast Blinking Red / 2 blinks per second	Charging error. For example: <ul style="list-style-type: none"><li>• Temperature is too low or too high.</li><li>• Charging has gone on too long without completion (typically 8 hours).</li></ul>
Solid Red	<ul style="list-style-type: none"><li>• Spare battery is charging and at the end of its useful life.</li><li>• Charging is complete, and the battery is at the end of its useful life.</li></ul>
Blinking Blue	Indicates an application notification is received.

# Using the Device

This section explains how to use the device.

## Waking the Device

The device goes into Sleep mode when you press Power or after a period of inactivity (set in the Display settings window).

1. To wake the device from Suspend mode, press Power.

The Lock screen displays.

2. Swipe the screen up to unlock.

- If the screen option is set to Swipe, the Home screen displays.
- If either the PIN or Password screen unlock feature is enabled, a prompt displays. Enter the PIN or password to unlock the device and move to the Home screen.
- If the Pattern screen unlock feature is enabled, the Pattern screen displays. Swipe the correct pattern between the dots to unlock the device and move to the Home screen.



**NOTE:** If you enter the PIN, password, or pattern incorrectly five times, you must wait 30 seconds before trying again. If you forget the PIN, password, or pattern, contact your system administrator.

## Home Screen

Turn on the device to display the Home screen. Depending on how your system administrator configured your device, your Home screen may display differently than the graphics in this section.

After the device goes into Sleep mode, the Home screen displays with the lock icon. Touch the screen and swipe up to unlock. The Home screen provides four additional screens to place widgets and shortcuts. Touch and hold on an icon, and then move it for the option to place the icon on one of the other screens. Swipe the Home screen left or right to view the additional screens



**NOTE:** By default, AOSP devices do not have the same icons on the Home screen as GMS devices. Icons are shown below for example only.

Home screen icons can be configured by you and may look different than shown.

**Figure 6** Example: MC3400 Home Screen

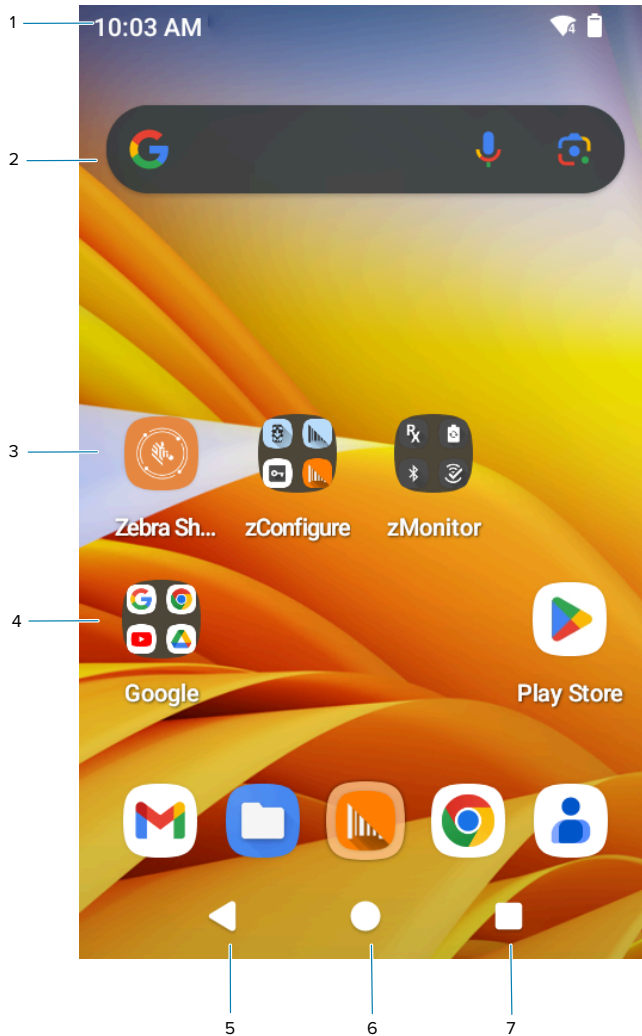

1	Status bar	Displays the time, status icons (right side), and notification icons (left side).
2	Widgets	Launches stand-alone apps that run on the Home screen.
3	Shortcut icons	Opens apps installed on the device.
4	Folder	Contains apps.
5	Back	Displays the previous screen.
6	Home	Displays the home screen.
7	Recent	Displays recently used applications.

## Setting Home Screen Rotation

By default, the Home screen rotation is disabled.



**NOTE:** Auto-rotate must be enabled in the Quick Access panel or in Settings before the Home Screen Rotation setting can be used.

1. Touch and hold anywhere on the Home screen until the options appear.
2. Touch **Home settings**.
3. Touch the **Allow Home screen rotation** switch.
4. Touch **Home**.
5. Rotate the device.

## Status Bar

The Status bar displays the time, notification icons (left side), and status icons (right side).

If there are more notifications than can fit in the Status bar, a dot is displayed, indicating that more notifications exist. Swipe down from the Status bar to open the Notification panel and view all notifications and status.

**Figure 7** Notifications and Status Icons



1	Notification icons
2	Status icons















## Notifications Icons

Notification icons indicate app events and messages.

**Table 4** Notification Icons

Icon	Description
	The main battery is low.
	More notifications are available for viewing.
	Data is syncing.
	Indicates an upcoming event. AOSP devices only.

**Table 4** Notification Icons (Continued)

















Icon	Description
	Indicates an upcoming event. GMS devices only.
	An Open Wi-Fi network is available. The device is not connected to it.
	Audio is playing.
	A problem with sign-in or sync has occurred.
	The device is uploading data.
	Animated: the device is downloading data. Static: the download is complete.
	The device is connected to or disconnected from a virtual private network (VPN).
	Preparing internal storage by checking it for errors.
	USB debugging is enabled on the device.
	A wired headset with a boom module is connected to the device.
	A wired headset without a boom module is connected to the device.
	PTT Express Voice client status.
	The RxLogger app is running.
	A Bluetooth scanner is connected to the device.
	A ring scanner is connected to the device in HID mode.



## Status Icons

Status icons display system information for the device.

**Table 5** Status Icons

Icon	Description
	Alarm is active.
	Main battery is fully charged.
	Main battery is partially drained.
	Main battery charge is low.
	Main battery charge is very low.
	Main battery is charging.
	All sounds except media and alarms are muted.
	Do Not Disturb mode active.
	Airplane Mode is active. All radios are turned off.
	Bluetooth is on.
	Connected to a Bluetooth device.
	Connected to a Wi-Fi network. Indicates the Wi-Fi version number.
	Not connected to a Wi-Fi network or no Wi-Fi signal.
	Connected to an Ethernet network.
	Speakerphone enabled.
	Indicates that a BT headset is connected to the device.

## Managing Notifications

Notification icons report the arrival of new messages, calendar events, alarms, and ongoing events. When a notification occurs, an icon appears in the Status bar with a brief description.

**Figure 8** Notification Panel

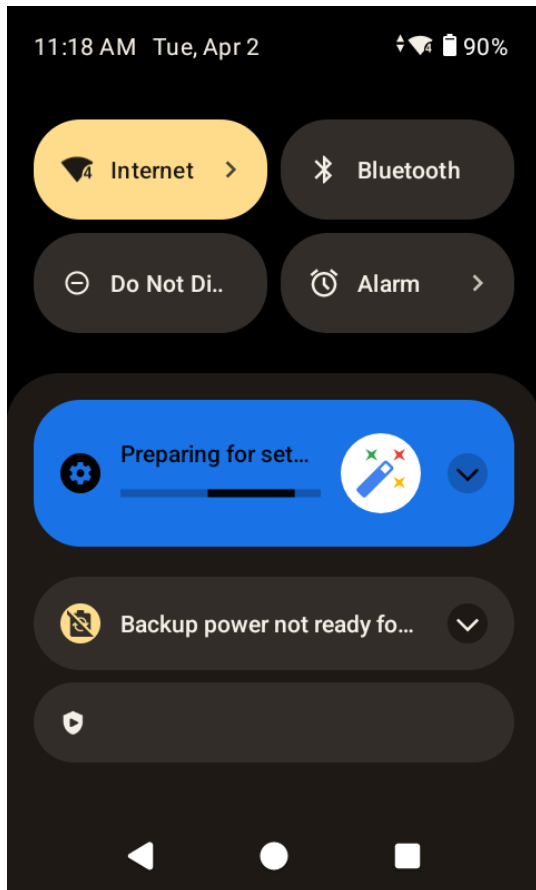

- To view a list of all notifications, open the Notification panel by dragging the Status bar down from the top of the screen.
- To respond to a notification, open the Notification panel and then touch a notification. The Notification panel closes and the corresponding app opens.
- To manage recent or frequently used notifications, open the Notification panel and then touch Manage notifications. Touch the toggle switch next to an app to turn off all notifications, or touch an app for more notification options.
- To clear all notifications, open the Notification panel and then touch **Clear all**. All event-based notifications are removed. Ongoing notifications remain in the list.
- To close the Notification panel, swipe the Notification panel up.

## Opening the Quick Access Panel

Use the Quick Access panel to access frequently used settings (for example, Airplane mode).



**NOTE:** Not all icons are pictured. Icons may vary.

**Figure 9** Quick Access Panel

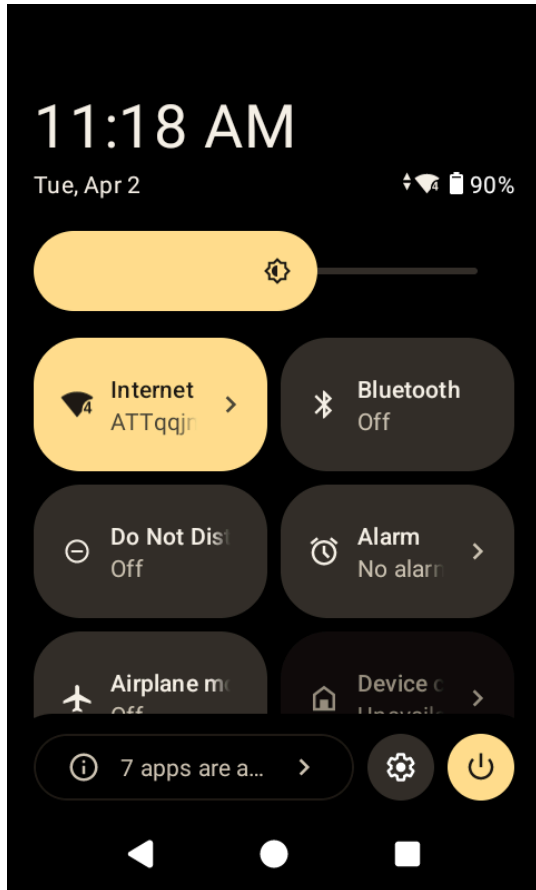















- If the device is locked, swipe down once.
- If the device is unlocked, swipe down once with two fingers, or twice with one finger.
- If the Notification panel is open, swipe down from the Quick Settings bar.

## Quick Access Panel Icons









Quick Access panel icons indicate frequently used settings (for example, Airplane mode).

Icon	Description
	Display brightness - Use the slider to decrease or increase the brightness of the screen.
	Internet/Wi-Fi network - Turn Wi-Fi on or off. To open Wi-Fi settings, touch the Wi-Fi network name.

## Using the Device

Icon	Description
	Bluetooth settings - Turn Bluetooth on or off. To open Bluetooth settings, touch Bluetooth.
	Battery saver - Turn Battery saver mode on or off. When Battery saver mode is on the performance of the device is reduced to preserve battery power (not applicable).
	Invert colors - Invert the display colors.
	Do not disturb - Control how and when to receive notifications.
	Mobile data - Enables or disables data transfer via the WAN. The device is still available for voice calls and texts. To open Mobile data settings, touch and hold (WWAN only).
	Airplane mode - Turn Airplane mode on or off. When Airplane mode is on the device does not connect to Wi-Fi or Bluetooth.
	Auto-rotate - Lock the device's orientation in portrait or landscape mode or set to automatically rotate.
	Flashlight - Turn the flashlight or camera flash on or off. When the flashlight is activated, it stays on unless it is turned off or the camera app is run.
	Location - Enable or disable locationing feature.
	Hotspot - Turn on to share the device's mobile data connection with other devices.
	Data Saver - Turn on to prevent some apps from sending or receiving data in the background.
	Night Light - Tint the screen amber to make it easier to look at the screen in dim light. Set Night Light to turn on automatically from sunset to sunrise, or at other times.
	Screen Cast - Share phone content on Chromecast or a television with Chromecast built-in. On the Cast screen, check the "enable wireless display" option, and then touch "cast screen" to display a list of devices. Touch a device in the list to begin casting.
	Dark Theme - Toggles dark theme on and off. Dark themes reduce the luminance emitted by the screen, while meeting minimum color contrast ratios. It helps improve visual ergonomics by reducing eye strain, adjusting brightness to current lighting conditions, and facilitating screen use in dark environments, while conserving battery power.
	Focus mode - Turn on to pause distracting apps. To open Focus mode settings, touch and hold.

## Using the Device

Icon	Description
	Bedtime mode - Turn grayscale on and off. Grayscale turns the screen black and white, reducing phone distractions and improving battery life.
	Screen Record - Makes a video recording of everything that happens on the screen, with options to include audio and screen touches.
	NFC - Enable or disable NFC communication.
	Wallet - Opens Android wallet.
	Scan QR code - Opens the camera app for QR code reading.
	Extra dim - Reduces screen brightness up to 50%.
	Color correction - Enable to help your device compensate for color blindness.
	Live caption - Enables captions to appear for any media playing, regardless of the device's volume level.
	Calculator - Open the calculator app.

## Editing the Quick Access Tiles

The first four setting tiles from the Quick Access panel become the Quick Access tiles on the Notification panel.

**Figure 10** Notification Panel

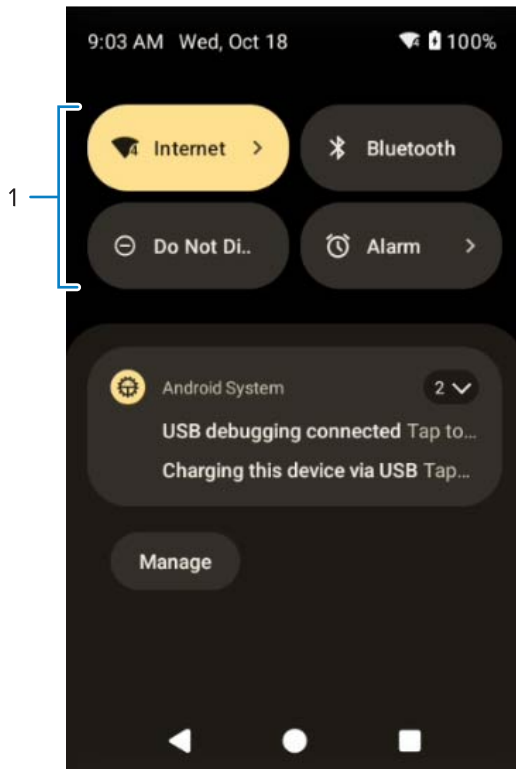

1	Quick access tiles
---	--------------------

- Open the Quick Access panel and touch  to edit, add, or remove settings tiles.

## Battery Management

Observe the recommended battery optimization tips for the device.

- Set the screen to turn off after a short period of inactivity.
- Reduce screen brightness.
- Turn off all wireless radios when not in use.
- Turn off automatic syncing for Email, Calendar, Contacts, and other apps.
- Minimize the use of apps that keep the device from sleeping, for example, music and video apps.



**NOTE:** Before checking the battery charge level, remove the device from any AC power source (cradle or cable).

## Checking Battery Status

Check the battery status through the Battery Information settings, the Battery Manager app, or the Quick Access panel.

- There are a couple of options to view the battery status:
  - Open **Settings** and touch **About phone** > **Battery Information**.
  - Swipe up from the bottom of the screen to open the **Apps** screen and touch  to open the **Battery Manager** app.
- The **Battery present status** indicates if the battery is present.
- The **Battery level** lists the battery charge (as a percentage).
- The **Battery percentage** is also displayed on the Status bar, next to the battery icon.

## Monitoring Battery Usage

The Battery screen provides battery charge details and power management options to extend battery life.

Different apps display different information. Some apps include buttons that open screens with settings to adjust power use. To turn off apps that consume too much power, touch the square (recent app) button at the bottom of the home screen. Swipe left or right to view recent applications. Swipe up on an application to close it

To display general battery information:

- Go to **Settings**.
- Touch **Battery**.

To display battery information and power management options for a specific app:

- Go to **Settings**.
- Touch **Apps** > **See all apps**.
- Select an app.
- Touch **App Battery Usage**.

The power management options display. Use **DISABLE** or **FORCE STOP** to turn off apps that consume too much power.

## Low Battery Notification

When the battery charge level drops below the change level in the following table, the device displays a notice to connect the device to power. Charge the battery using one of the charging accessories.

Charge Level Drops Below	Action
15%	Charge the battery soon.
8%	Charge the battery.
6%	The device turns off. Charge the battery.

## USB Communication

Connect the device to a host computer to transfer files between the device and the host computer.

When connecting the device to a host computer, follow the host computer's instructions for connecting and disconnecting USB devices to avoid damaging or corrupting files.



**NOTE:** If moisture is in the USB port, disconnect the USB-C cable immediately.

Also go to [USB Connection](#) for more information.

## Transferring Files

Use the Transfer files option to copy files between the device and the host computer.

1. Connect the device to a host computer using a USB accessory.
2. On the device, pull down the Notification panel and touch **Charging this device via USB**.  
By default, **No data transfer** is selected.
3. Touch **File Transfer**.
4. On the host computer, open a file explorer application.
5. Locate the **device** as a portable device.
6. Open the SD card or the Internal storage folder.
7. Copy files to and from the device or delete files as required.

## Transferring Photos

Use PTP to copy photos from the device to the host computer.

1. Connect the device to a host computer using a USB accessory.
2. On the device, pull down the Notification panel and touch **Charging this device via USB**.
3. Touch **PTP**.
4. On the host computer, open a file explorer application.
5. Open the SD card or the Internal storage folder.
6. Copy or delete photos as required.

## Disconnecting from the Host Computer



**NOTE:** Carefully follow the host computer's instructions to unmount the microSD card and disconnect USB devices correctly to avoid losing information.

1. On the host computer, unmount the device.
2. Remove the device from the USB accessory.



## Interactive Sensor Technology

The device contains sensors that monitor movement and orientation.

To take advantage of these sensors, applications use API commands. Refer to the Google Android Sensor APIs for more information. For information on the Zebra Android EMDK, go to [techdocs.zebra.com](http://techdocs.zebra.com).



- Gyroscope - Measures angular rotational velocity to detect rotation of the device.
- Accelerometer - Measures the linear acceleration of movement to detect the orientation of the device.

# Settings

This section describes the settings on the device.

## Accessing Settings

There are multiple ways to access Settings on a device.

- Double swipe from the top of the Home screen to open the Quick Access panel and touch .
- Swipe from the bottom of the Home screen to view all Apps and touch .

## Display Settings

Use Display settings to change the screen brightness, enable night light, change the background image, enable screen rotation, set screen timeout, and change font size.

### Setting the Screen Brightness Manually

Manually set the screen brightness using the touchscreen.

1. Double swipe from the top of the Home screen to open the Quick Access panel.
2. Slide  left or right to adjust the screen brightness level.

### Setting Night Light

The Night Light setting tints the screen amber, making the screen easier to look at in low light.

1. Go to **Settings**.
2. Touch **Display**.
3. Touch **Night Light**.
4. Touch **Schedule**.
5. Select one of the schedule values:
  - **None** (default)
  - **Turns on at custom time**
  - **Turns on from sunset to sunrise**

6. By default, **Night Light** is disabled. Touch **TURN ON NOW** to enable.
7. Adjust the tint using the **Intensity** slider.

## Setting Screen Rotation

By default, screen rotation is enabled.



**NOTE:** To change the Home Screen rotation, go to [Setting Home Screen Rotation](#).

1. Go to **Settings**.
2. Touch **Display** > **Auto-rotate screen**.
3. Touch **Home**.

## Setting Screen Timeout

The screen turns off and goes into Suspend mode after the selected period of inactivity.

1. Go to **Settings**
2. Touch **Display** > **Screen timeout**.
3. Select one of the sleep values:
  - **15 seconds**
  - **30 seconds**
  - **1 minute** (default)
  - **2 minutes**
  - **5 minutes**
  - **10 minutes**
  - **30 minutes**
  - **Never**
4. Turn on the **Screen attention** switch to prevent your screen from turning off while you are looking at it.

## Setting the Date and Time

The date and time are automatically synchronized using a NITZ server when the device is connected to a cellular/wireless network.

You are only required to set the time zone or set the date and time if the WLAN does not support Network Time Protocol (NTP) or when not connected to a cellular/wireless network.

1. Go to **Settings**.
2. Touch **System** > **Date & time**.
3. Touch **Set time automatically** to disable automatic date and time synchronization.
4. Touch **Set time zone automatically** to disable automatic time zone synchronization.
5. Touch **Date** to select the date in the calendar.
6. Touch **OK**.

7. Touch **Time**.
  - a) Touch the circle, drag to the current hour, and release.
  - b) Touch the circle, drag to the current minute, and release.
  - c) Touch **OK**.
8. Touch **Time zone** to select the current time zone from the list.
9. Touch **Update Interval** to select an interval to synchronize the system time from the network.
10. In **Time format**, turn on the switches for either **Use local default** or **Use 24-hour format**.

## Setting Display and Text Sizes

Set the text size (font) in system apps and for the display.

As you adjust the sizes, the **Preview** section displays the changes made.

1. Go to **Settings**.
2. Touch **Display > Display size and text**.
  - In **Font size**, slide the circle (or touch - or +) to adjust the text size.
  - In **Display size**, slide the circle (or touch - or +) to adjust the display size.
  - Turn on the **Bold text** switch to improve text visibility.
  - Turn on the **High contrast text** switch to change the text color to black or white, which maximizes the contrast with the background.

## Setting Touch Panel Mode

The device can detect touches using a finger, a conductive-tip stylus, or a gloved finger. For optimal performance, use a Zebra-certified stylus.

Gloves types include medical latex, leather, cotton, or wool. There are gloves that support (and do not support) a device's touchscreen. Make sure to review the type of gloves that each device supports.

To select a touch panel setting:

1. Go to **Settings**.
2. Touch **Display > Touch panel mode**.
3. Select:
  - **Finger Only** to use a finger on the screen (default).
  - **Stylus and Finger (Screen Protector OFF)** to use a finger or a stylus on the screen without a screen protector.
  - **Glove and Finger (Screen Protector OFF)** to use a finger or a gloved finger on the screen without a screen protector.
  - **Stylus and Finger (Screen Protector ON)** to use a finger or a stylus on the screen with a screen protector.
  - **Glove and Finger (Screen Protector ON)** to use a finger or a gloved finger on the screen with a screen protector.

## General Sound Setting

Press the volume buttons on the device to display on-screen volume controls.

Use the Sound settings to configure media and alarm volumes.

1. Go to **Settings**.

2. Touch **Sound & Vibration**.

A list of sound and vibrate options display.

3. Touch an option to set sounds.

## Sound Options

- **Media volume** - Controls the music, games, and media volume.
- **Call volume** - Controls the volume during a call.
- **Ring & notification volume** - Controls the ringtone and notification volume.
- **Alarm volume** - Controls the alarm clock volume.
- **Do Not Disturb** - Mutes some or all sounds and vibrations.
- **Phone ringtone** - Select a sound to play when the phone rings.
- **Live Caption** - Detects speech on your device and automatically generates captions.
- **Media** - Shows the media player in Quick Settings while sound is playing, allowing quick access.
- **Vibration & haptics** - Enable or disable vibration and/or haptic settings.
- **Shortcut to prevent ringing** - Turn off the switch to prevent the device from vibrating when a call is received (default - enabled).
- **Default notification sound** - Select a sound to play for all system notifications.
- **Default alarm sound** - Select a sound to play for alarms.
- **Dial pad tones** - Play a sound when pressing keys on dial pad (default - disabled).
- **Screen locking sounds** - Play a sound when locking and unlocking the screen (default - enabled).
- **Charging sounds and vibration** - Play a sound and vibrate when power is applied to the device (default - enabled).
- **Touch sounds** - Play a sound when making screen selections (default – enabled).
- **Always show icon when in vibrate mode** - Turn on the switch to show the icon when in vibrate mode (default - disabled)

## Zebra Volume Controls

In addition to the default sound settings, Zebra Volume Controls display when the volume buttons are pressed.

Zebra Volume Controls are configured using Audio Volume UI Manager (AudioVolUIMgr). Administrators can use AudioVolUIMgr to add, delete and replace Audio Profiles, select an Audio Profile to use the device, and modify the default Audio Profile. For information on how to configure Zebra Volume Controls using AudioVolUIMgr, refer to [techdocs.zebra.com](https://techdocs.zebra.com).

## Remappable Keys

Program the remappable keys to different functions or as shortcuts to installed apps.

**Figure 11** Key Positions

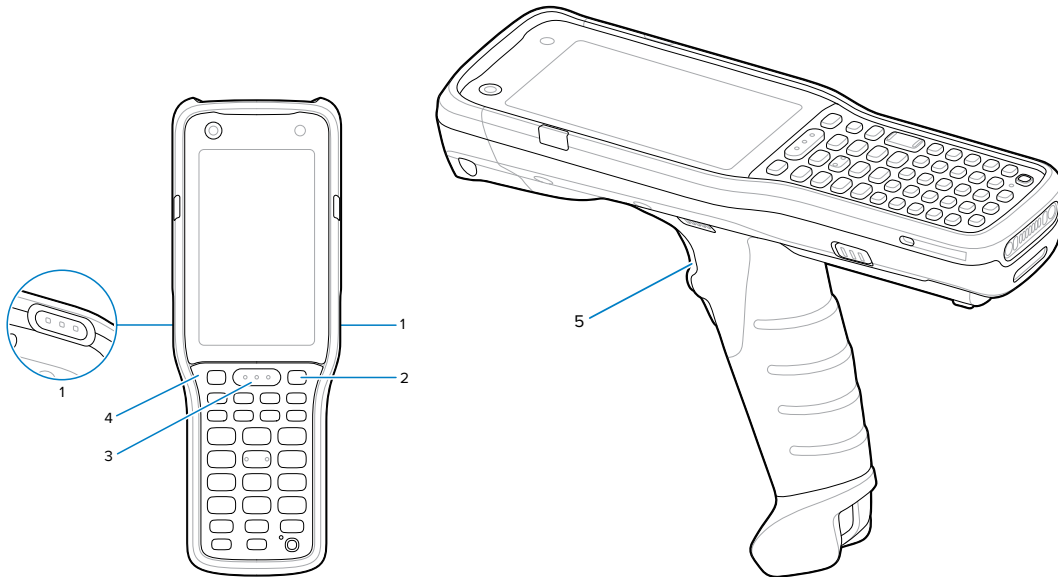

1	LEFT_TRIGGER_1 and RIGHT_TRIGGER_1
2	DIAMOND
3	SCAN
4	P1
5	GRIP_TRIGGER

### UI Listed Keys

- GRIP\_TRIGGER
- SCAN
- P1
- DIAMOND
- LEFT\_TRIGGER\_1
- RIGHT\_TRIGGER\_1

### Other Remappable Keys

- 0-9
- A-Z
- F1-F10

- LEFT
- UP
- DOWN
- RIGHT
- ENTER
- SPACE
- ESC
- DOT (via XML only, not StageNow)
- TAB
- DELETE
- COMMA
- SHIFT
- CTRL
- ALT
- BLUE
- ORANGE

### Non-Remappable Keys

- POWER
- BACK (Not a physical key)
- HOME (Not a physical key)
- RECENT (Not a physical key)

## Language Usage

Use the **Language & input** settings to change the device's language, including words added to the dictionary.

### Changing the Language Setting

1. Go to **Settings**.
2. Touch **System > Languages & input**.
3. Touch **Languages**.  
A list of available languages displays.
4. If the desired language is not listed, touch **Add a language** and select a language from the list.
5. Touch and hold  to the right of the desired language, then drag it to the top of the list.  
The operating system text changes to the selected language.

## Adding Words to the Dictionary

This section describes adding words to the user dictionary.

1. Go to **Settings**
2. Touch **System** > **Languages & input** > **Personal dictionary**.  
If prompted, select the language where this word or phrase is stored.
3. Touch + to add a new word or phrase.
4. Enter the new word or phrase.
5. (Optional) In the **Shortcut** field, enter a shortcut for the word or phrase.
6. Touch the Back button.

The new word or phrase displays. Touch the word or phrase to edit.

## Keyboards

The device provides multiple keyboard options.

- Android Keyboard - AOSP devices only
- Gboard - GMS devices only
- Enterprise Keyboard - Not pre-installed on the device. Contact Zebra Support for more information.



**NOTE:** By default, the Enterprise and Virtual Keyboards are disabled. The Enterprise Keyboard is available for download from the [Zebra Support Site](#).

## Keyboard Configuration

This section describes configuring the device's keyboard.

### Enabling Keyboards



1. Go to **Settings**.
2. Touch **System** > **Languages & input** > **On-screen keyboard** > **Manage on-screen keyboards**.
3. Touch a keyboard to enable.

### Switching Between Keyboards

To switch between keyboards, touch in a text box to display the current keyboard.



**NOTE:** By default, the Gboard is enabled. All other virtual keyboards are disabled.

- On the Gboard keyboard, touch and hold  (GMS devices only).
- On the Android keyboard, touch, and hold  (AOSP devices only).
- On the Enterprise keyboard, touch . Only available with Mobility DNA Enterprise License. Not pre-installed on the device. Contact Zebra Support for more information.



## Using the Android and Gboard Keyboards

Use the Android or Gboard keyboards to enter text in a text field.

- To configure the keyboard settings, touch and hold "," (comma) and then select **Android keyboard settings**.

### Edit Text

Edit entered text and use menu commands to cut, copy, and paste text within or across apps. Some apps do not support editing some or all of the text they display; others may offer their own way to select text.

### Entering Numbers, Symbols, and Special Characters

1. Enter numbers and symbols.
  - Touch and hold one of the top-row keys until a menu appears then select a number or special character.
  - Touch the Shift key once for a single capital letter. Touch the Shift key twice to lock in uppercase. Touch the Shift key a third time to unlock Capslock.
  - Touch **?123** to switch to the numbers and symbols keyboard.
  - Touch the =< key on the numbers and symbols keyboard to view additional symbols.
2. Enter special characters.
  - Touch and hold a number or symbol key to open a menu of additional symbols. A larger version of the key displays briefly over the keyboard.

## Enterprise Keyboard

The Enterprise Keyboard contains multiple keyboard types.



**NOTE:** Only available with Mobility DNA Enterprise License.

- Numeric
- Alpha
- Special characters
- Data capture

### Numeric Tab

The numeric keyboard is labeled **123**. The keys displayed vary on the app being used. For example, an arrow displays in **Contacts**, however **Done** displays in **Email** account setup.

### Alpha Tab

The alpha keyboard is labeled using the language code. For English, the alpha keyboard is labeled **EN**.

## Additional Character Tab

The additional characters keyboard is labeled **#\*/**.

- Touch  to enter emoji icons in a text message.
- Touch **ABC** to return to the Symbols keyboard.

## Scan Tab

The Scan tab provides an easy data capture feature for scanning barcodes.

# Notifications

Device notification settings allow you to configure how notifications occur on the device, and app notification settings allow you to configure how notifications for a specific app occur.

To view device notification settings, touch **Settings > Apps & notifications > Notifications**.

To view app notifications, touch **Settings > Apps & notifications > App info**, and then select an app.

## Viewing Notifications

Check notifications from applications that have been disabled to ensure you receive important updates.

1. Go to **Settings**.
2. Touch **Notifications > App settings**.  
The **App notifications** screen displays.
3. From the drop-down menu, select **Turned off** to view how many app notifications are turned off.

## Controlling Lock Screen Notifications

Control whether notifications are seen when the device is locked.

1. Go to **Settings**.
2. Touch **Notifications**.
3. Touch **Notifications on lock screen** and select one of the following:
  - **Show conversations, default, and silent** (default)
  - **Hide silent conversations and notifications**
  - **Don't show any notifications**

## Enabling Blink Light

The Notification LED lights are blue when an app, such as email and Voice over Internet Protocol (VoIP), generates a programmable notification or to indicate when the device is connected to a Bluetooth device. By default, LED notifications are enabled.

1. Go to **Settings**
2. Touch **Notifications**.

3. Touch **Blink light** to toggle on or off.







# Applications

Apart from the standard pre-installed Android applications, the following table lists Zebra-specific applications installed on the device.







## Installed Applications

This section describes the Zebra-specific apps that are installed on the device.

**Table 6** Apps



Item	Description
	<b>Battery Manager</b> - Displays battery information (including charge level, status, health, and wear level) and use to place the device in Battery Swap mode when replacing the battery.
	<b>Bluetooth Pairing Utility</b> - Pair a Zebra Bluetooth scanner with the device by scanning a barcode.
	<b>Camera</b> - Take photos or record videos.
	<b>DataWedge</b> - Enables data capture using the imager.
	<b>DWDemo</b> - Provides a way to demonstrate the data capture features using the imager.
	<b>License Manager</b> - Use to manage software licenses on the device.
	<b>RxLogger</b> - Use to diagnose device and app issues.

**Table 6** Apps (Continued)

Item	Description
	<b>StageNow</b> - Allows the device to stage a device for initial use by initiating the deployment of settings, firmware, and software.
	<b>VoD</b> - The Video on Device basic app provides a how-to video for proper device cleaning. For Video on Device licensing information, go to <a href="http://learning.zebra.com">learning.zebra.com</a> .
	<b>Wireless Analyzer</b> - A diagnostic intelligent app. Diagnose the surrounding areas and display network stats, such as coverage hole detection or AP in the vicinity. Refer to the Wireless Analyzer Administrator Guide for Android. Only available with Mobility DNA Enterprise License.
	<b>Zebra Bluetooth Settings</b> - Use to configure Bluetooth settings.
	<b>Zebra Data Services</b> - Use to enable or disable Zebra Data Services. Some options are set by the system administrator.
	<b>Zebra Showcase</b> - Provides a way to experience and learn about Zebra's new or existing capabilities.

## Accessing Settings

There are multiple ways to access Settings on a device.

- Double swipe from the top of the Home screen to open the Quick Access panel and touch .
- Swipe from the bottom of the Home screen to view all Apps and touch .

## Switching Between Recent Apps

If multiple apps are open, switch from one app to another.

1. Touch the Recent button.  
The app screens display. If there are no recently used app screens, it displays **No recent items**.
2. Slide left and right to view all used apps.
3. Swipe up to remove the app from the list and force close the app.
4. Tap an app screen to go back to the app's session.

## Battery Manager



The Battery Manager provides detailed information about the battery.

To open the app, swipe up from the bottom of the Home screen, and then touch .

## Battery Manager Information Tab

The Battery Manager displays detailed information about battery charging, health, and status.

**Table 7** Battery Icons

Battery Icon	Description
	Battery charge level is between 85% and 100%.
	Battery charge level is between 19% and 84%.
	Battery charge level is between 0% and 18%.

- **Level** - The current battery charge level as a percentage. Displays -% when the level is unknown.
- **Wear** - The health of the battery in graphical form. When the wear level exceeds 80%, the bar color changes to red.
- **Health** - The health of the battery. If a critical error occurs,  appears. Touch to view the error description.
  - **Decommission** - The battery is past its useful life and should be replaced. See system administrator.
  - **Good** - The battery is good.
  - **Charge error** - An error occurred while charging. See system administrator.
  - **Over Current** - An over-current condition occurred. See system administrator.
  - **Dead** - The battery has no charge. Replace the battery.
  - **Over Voltage** - An over-voltage condition occurred. See system administrator.
  - **Below Temperature** - The battery temperature is below the operating temperature. See system administrator.
  - **Failure Detected** - A failure has been detected in the battery. See system administrator.
  - **Unknown** - See system administrator.
- **Charge Status**
  - **Not charging** - The device is not connected to AC power.
  - **Not charging** - The device is not charging.
  - **Charging-AC** - The device is connected to AC power and charging or is fast charging via USB.
  - **Charging-USB** - The device is connected to a host computer with a USB cable and charging.
  - **Discharging** - The battery is discharging.
  - **Full** - The battery is fully charged.
  - **Unknown** - The battery status is unknown.
- **Time until Full** - The amount of time until the battery is fully charged.
- **Time since charging** - The amount of time since the device began charging.

- **Time until empty** - The amount of time until the battery is empty.
- **Advanced info** - Touch to view additional battery information.
- **Battery present status** - Indicates that the battery is present.
- **Battery level** - The battery charge level as a percentage of scale.
- **Battery scale** - The battery scale level used to determine battery level (100).
- **Battery voltage** - The current battery voltage in millivolts.
- **Battery temperature** - The current battery temperature in degrees Centigrade.
- **Battery technology** - The type of battery.
- **Battery current** - The average current into or out of the battery over the last second in mAh.
- **Battery manufacture date** - The date of manufacture.
- **Battery serial number** - The battery serial number. The number matches the serial number printed on the battery label.
- **Battery part number** - The battery part number.
- **Battery rated capacity** - Lists the rated capacity of the backup battery in mAh.
- **Battery decommission status** - Indicates if the battery is past its life span.
  - **Battery Good** - The battery is in good health.
  - **Decommissioned Battery** - The battery is past its useful life and should be replaced.
- **Base cumulative charge** - Cumulative charge using Zebra charging equipment only.
- **Battery present capacity** - Maximum amount of charge that could be pulled from the battery under the present discharge conditions if the battery were fully charged.
- **Battery health percentage** - With a range from 0 to 100, this is the ratio of “present\_capacity” to “design\_capacity” at a discharge rate of “design\_capacity”.
- **% decommission threshold** - The default % decommission threshold for a gifted battery as 80%.
- **Battery present charge** - Amount of usable charge remaining in the battery at present under the current discharge conditions.
- **Battery total cumulative charge** - The total accumulated charge in all chargers.
- **Battery time since first use** - The time passed since the battery was placed in a Zebra terminal for the first time.
- **Battery error status** - The error status of the battery.
- **Battery usage number** - The health of the battery as a result of charging and discharging. A high number indicates low battery health.
- **Usage decommission threshold** - When the Battery usage number is greater than or equal to the Usage decommission threshold, the battery is past its useful life and should be replaced.
- **App version** - The application version number.

## Camera

This section provides information on taking photos and recording videos using the integrated digital cameras.

If a microSD card is installed and the storage path is manually changed, photos and videos are saved on the card. If the microSD card is not installed (default), the device saves photos and videos on internal storage.



**NOTE:** The Camera app is only available on Full Featured (Gun and Straight Shooter) configurations.

## Taking Photos

This section describes how to use the photo feature on the Camera app.



**NOTE:** See [Camera and Video Settings](#) for setting descriptions.



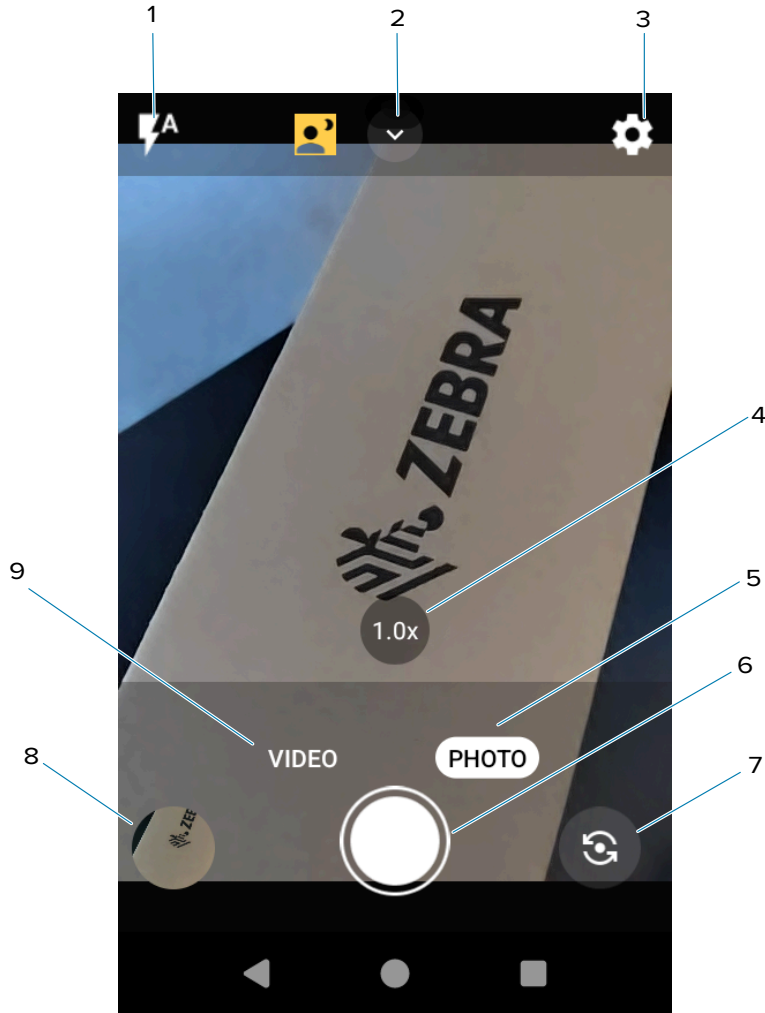

1. Swipe up from the bottom of the Home screen and touch **Camera** . Photo mode is the standard mode that displays.



1	Flash
2	Camera Quick Settings
3	Camera App Settings
4	Zoom
5	Photo mode
6	Shutter button
7	Rear/front cameras
8	Thumbnail
9	Video mode

2. To switch between the rear camera and front camera (if available), touch .

3. Frame the subject on the screen.
4. Touch an area on the screen to focus. The yellow focus box displays and places that area into focus. Alternatively, **AutoFocus Animation** can be enabled in **Settings**, and the yellow focus box automatically appears when in focus.
5. To turn the Flash on, touch , which can also be accessed via Quick Settings Menu.
6. To zoom in or out, the following options are available:
  - Tap **1.0x** zoom to toggle between **1.0x** and **2.0x**.
  - Press and hold the **1.0x** zoom icon until the zoom slider displays. Slide the slider to the desired zoom.
  - Touch and hold an area with two fingers, then spread them apart to zoom in or pinch them together to zoom out.
7. Touch  to take a photo. A shutter sound emits.

### Recording Videos

This section describes how to use the video feature on the Camera app.



**NOTE:** See [Camera and Video Settings](#) for setting descriptions.

1. Swipe up from the bottom of the Home screen and touch **Camera** .

2. Touch **Video**.

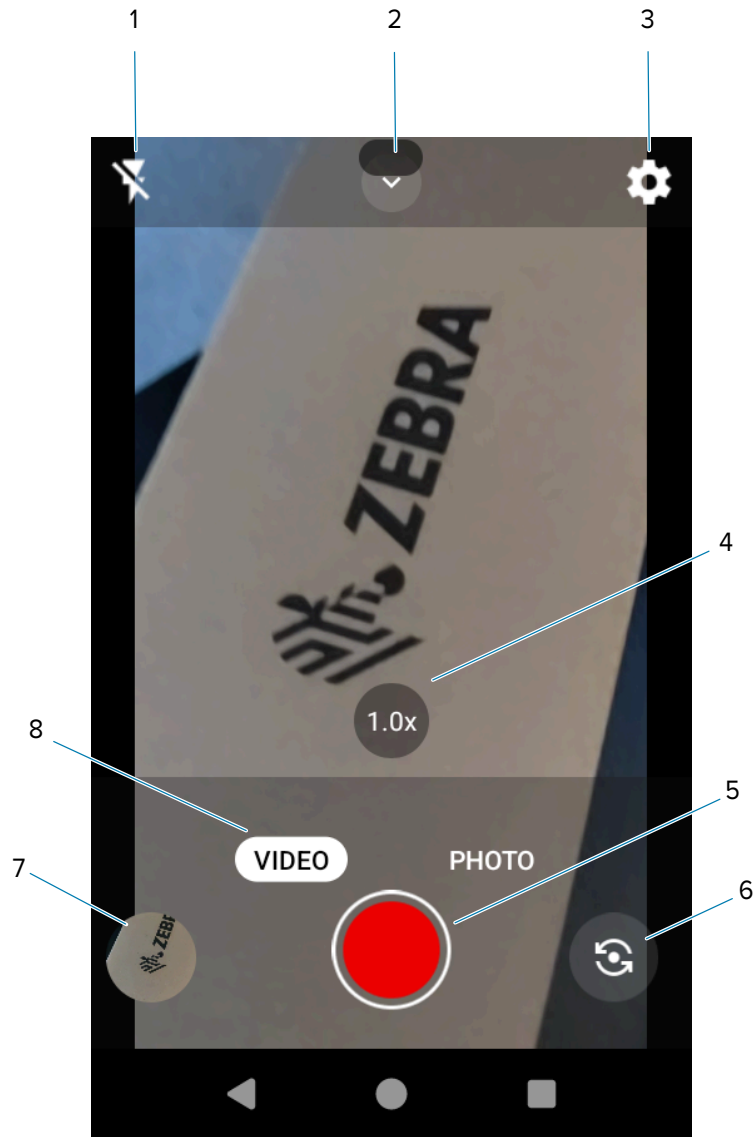

1	Flash
2	Video Quick Settings
3	Camera/Video App Settings
4	Zoom
5	Start/stop recording button
6	Rear/front cameras
7	Thumbnail
8	Video mode

3. To switch between the rear camera and front camera, touch .

4. Point the camera and frame the scene.
5. Touch an area on the screen to focus. The yellow focus box displays and places that area into focus. Alternatively, **AutoFocus Animation** can be enabled in **Settings**, and the yellow focus box automatically appears when in focus.
6. To turn the Flash on, touch the  icon, which can also be accessed via the Quick Settings Menu.
7. To zoom in or out, the following options are available:
  - Tap **1.0x** zoom to toggle between **1.0x** and **2.0x**.
  - Press and hold the **1.0x** zoom icon until the zoom slider displays. Slide the slider to the desired zoom.
8. Touch **Record (Start)**. The video timer displays at the top of the screen.

The video timer displays at the top of the screen. To stop the recording, touch **Record** again.

### Camera and Video Settings

In Photo or Video mode, camera settings are displayed on the screen by touching  on the top right.

- **General** - These settings apply to both the still camera and video.
  - **Camera Sounds** - Enable (default) or disable camera sounds.
  - **Location Tags** - Enable location information when pictures and videos are taken.
  - **Storage** - Photos and videos are stored on the phone.
  - **Dirty Lens Detection** - Enable to receive alerts when the camera lens is dirty.
  - **QR Code Mode** - Enable QR Code scanning with an option to open URLs via the browser (Rear camera and video only).
  - **Google Lens Mode** - Enable Google-developed recognition technology that displays relevant information about identified objects within an image.
  - **Digital Level** - Enable digital guide to keep photos aligned.
  - **Face Detection** - Enable to turn on (or off).
  - **Gestures** - View gestures and power user controls. Gestures include **Swipe Down**, **Swipe Up**, **Side Swipe**, **Tap**, **Tap + Hold**, **Double Tap**, and **Hold Zoom**.

- **Still Camera** - These settings only apply to the still camera.
  - **Photo Grid** - Enable to apply a 3x3 grid guide to the camera viewport.
  - **Countdown timer** - Select **Off** (default), **3 seconds**, or **10 seconds**.
  - **Selfie Mirror** - Enable to save a mirror image of the photo (Front camera and video only).
  - **Picture size** - Set the size (in pixels) of the photo to **13M pixel** (default for rear camera/video), **8M pixels**, **5M pixels** (default for front camera/video), **WVGA**, **VGA**, or **QVGA**.
  - **Picture quality** - Set setting to **Low**, **Standard**, or **High** (default).
  - **Selfie Flash** - Enable to turn on the front-facing flash (Front camera and video only).
  - **Picture Format** - All still images are saved in **JPEG** (default) or **RAW + JPEG** format.
  - **MFNR** - Disabled (default) Multi-frame Noise Reduction improves picture quality in low-light conditions.
  - **AutoFocus Animation** - Enable the camera focus ring in the camera preview (Rear camera and video only).
- **Video Camera** - These settings only apply to the video camera.
  - **Video quality** - Set the video quality to **HD 1080p** (default), **HD 720p**, **SD 480p**, **VGA**, **CIF**, or **QVGA**.
  - **Video duration** - Set to **30 seconds (MMS)**, **10 minutes** (default), **30 minutes**, or **no limit**.
  - **Noise Reduction** - Set to **Off**, **Fast**, or **High Quality** (default).
  - **HEVC Encoder** - Enable to save video recording using a high-efficiency video encoder for a smaller file size.
  - **Audio Encoder** - Set the audio encoder to **AMRNB** or **AAC** (default).
  - **Video Rotation** - Set the rotation to **0** (default), **90**, **180**, or **270**.
- **System**
  - **Restore defaults** - Select to restore all settings to the default values.
  - **About** - Displays the software version of the camera app.

## DWDemo

Use DataWedge Demonstration (DWDemo) to demonstrate data capture functionality. To configure DataWedge, refer to [techdocs.zebra.com/datawedge/](http://techdocs.zebra.com/datawedge/).



**NOTE:** DataWedge is enabled on the Home screen. To disable this feature, go to the DataWedge settings and disable the **Launcher** profile.









## DWDemo Icons

This section describes the DWDemo icon features.

**Table 8** DWDemo Icons

Category	Icon	Description
Illumination		Imager illumination is on. Touch to turn illumination off.

**Table 8** DWDemo Icons (Continued)

Category	Icon	Description
Illumination		Imager illumination is off. Touch to turn illumination on.
Data Capture		The data capture function is through the internal imager.
Data Capture		A Bluetooth scanner is connected.
Data Capture		A Bluetooth scanner is not connected.
Data Capture		The data capture function is through the rear camera.
Scan Mode		Imager is in picklist mode. Touch to change to normal scan mode.
Scan Mode		Imager is in normal scan mode. Touch to change to picklist mode.
Menu		Opens a menu to view the application information or to set the application DataWedge profile.

## Rxlogger

RxLogger is a comprehensive diagnostic tool that provides application and system metrics, and diagnoses device and application issues.

RxLogger logs the following information: CPU load, memory load, memory snapshots, battery consumption, power states, wireless logging, cellular logging, TCP dumps, Bluetooth logging, GPS logging, logcat, FTP push/pull, ANR dumps, etc. All generated logs and files are saved onto flash storage on the device (internal or external).

### RxLogger Configuration

RxLogger is built with an extensible plug-in architecture and comes packaged with a number of plug-ins already built-in. For information on configuring RxLogger, refer to [techdocs.zebra.com/rxlogger/](http://techdocs.zebra.com/rxlogger/).

To open the configuration screen, from the RxLogger home screen, touch **Settings**.

### Configuration File

All RxLogger settings are stored in a file on the device, permitting remote configuration and mass deployment of setting files using an enterprise mobile management (EMM) system.

The config.json configuration file is located on the microSD card in the RxLogger\config folder. Copy the file from the device to a host computer using a USB connection. Edit the configuration file and then replace the JSON file on the device. There is no need to stop and restart the RxLogger service because the file change is automatically detected.



**IMPORTANT:** The RxLogger configuration file is human-readable. Do not edit it by hand because it can lead to unpredictable behavior. Zebra recommends modifying RxLogger settings only through the RxLogger UI.

- File name: `config.json`
- Location: `/<internal_storage>/RxLogger`
- With external SD Card: `/storage/sdcard1/RxLogger`
- With no external SD Card: `/storage/sdcard0/RxLogger`

When a new settings file is pushed to the device, RxLogger restarts all affected modules and applies the new settings immediately.

## Enabling Logging

1. Swipe the screen up and select .
2. Touch **Start**.

## Disabling Logging

1. Swipe the screen up and select .
2. Touch **Stop**.

## Extracting Log Files

1. Connect the device to a host computer using a USB connection.
2. Using a file explorer, navigate to the RxLogger folder.
3. Copy the file from the device to the host computer.
4. Disconnect the device from the host computer.

## Backing Up Data

RxLogger Utility allows the user to make a zip file of the RxLogger folder in the device, which by default contains all the RxLogger logs stored in the device.

- To save the backup data, touch  > **BackupNow**.

## RxLogger Utility

RxLogger Utility is a data monitoring application for viewing logs in the device while RxLogger is running. Logs and RxLogger Utility features are accessed using Main Chat Head.

### Initiating the Main Chat Head

1. Open **RxLogger**.
2. Touch  > **Toggle Chat Head**.  
The Main Chat Head icon appears on the screen.

3. Touch and drag the Main Chat Head icon to move it around the screen.

### Removing the Main Chat Head

1. Touch and drag the icon.  
A circle with an X appears.
2. Move the icon over the circle and then release.

### Viewing Logs

1. Touch the Main Chat Head icon.  
The RxLogger Utility screen displays.
2. Touch a log to open it.  
Open many logs with each displaying a new Sub Chat Head.
3. If necessary, scroll left or right to view additional Sub Chat Head icons.
4. Touch a Sub Chat Head to display the log contents.

### Removing a Sub Chat Head Icon

- To remove a Sub Chat Head icon, press and hold the icon until it disappears.

### Backing Up In Overlay View

RxLogger Utility allows the user to make a zip file of the RxLogger folder in the device, which by default contains all the RxLogger logs stored in the device.

The Backup icon is always available in Overlay View.

1. Touch .  
The Backup dialog box appears.
2. Touch **Yes** to create the backup.



# Data Capture

This section provides information for capturing barcode data using various scanning options.



**NOTE:** The DataWedge app is installed and enabled on the device by default.

The device supports data capture using:

- Integrated camera
- Integrated SE55 imager
- Integrated SE58 imager
- Integrated SE4710 imager
- Integrated SE4770 imager
- RS5100 Bluetooth Scanner
- RS6000 Bluetooth Scanner
- DS3678 Digital Scanner
- DS2278 Digital Scanner
- DS8178 Digital Scanner
- LI3678 Linear Scanner

## Imaging

The device with an integrated 2D imager has the following features:

- Omnidirectional reading of a variety of barcode symbologies, including the most popular linear, postal, PDF417, Digimarc, and 2D matrix code types.
- The ability to capture and download images to a host for a variety of imaging applications.
- Advanced intuitive laser aiming cross-hair and dot aiming for easy point-and-shoot operation.

The imager uses imaging technology to take a picture of a barcode, stores the resulting image in memory, and executes state-of-the-art software decoding algorithms to extract the barcode data from the image.

## Operational Modes

The device with an integrated imager supports three modes of operation.

Activate each mode by pressing **Scan**.

- Decode mode — The device attempts to locate and decode enabled barcodes within its field of view. The imager remains in this mode as long as you hold the scan button, or until it decodes a barcode.



**NOTE:** To enable Picklist Mode, configure in DataWedge or set in an application using an API command.

- Picklist mode — Selectively decode a barcode when more than one barcode is in the device's field of view by moving the aiming crosshair or dot over the required barcode. Use this feature for pick lists containing multiple barcodes and manufacturing or transport labels containing more than one barcode type (either 1D or 2D).



**NOTE:** To enable MultiBarcode Mode, configure in DataWedge or set in an application using an API command.

- MultiBarcode Mode — In this mode, the device attempts to locate and decode a specific number of unique barcodes within its field of view. The device remains in this mode as long as you hold the scan button, or until it decodes all the barcodes.
  - The device attempts to scan the programmed number of unique barcodes (from 2 through 100). This may be a fixed amount, meaning it scans X unique barcodes, or can be set as a range to scan a different number of unique barcodes each session.
  - If there are duplicate barcodes (same symbology type and data), only one of the duplicate barcodes is decoded and the remainder are ignored. If the label has two duplicate barcodes plus another two different barcodes, a maximum of three barcodes will be decoded from that label; one will be ignored as a duplicate.
  - Barcodes can be of multiple symbology types and still be acquired together. For example, if the specified quantity for a MultiBarcode Mode scan is four, two barcodes can be symbology type Code 128 and the other two can be symbology type Code 39.
  - If the specified number of unique barcodes is not initially in view of the device, the device will not decode any data until the device is moved to capture the additional barcode(s) or time out occurs. If the device field of view contains a number of barcodes greater than the specified quantity, the device randomly decodes barcode(s) until the specified number of unique barcodes is reached. For example, if the count is set to two and eight barcodes are in the field of view, the device decodes the first two unique barcodes it sees, returning the data in random order.
  - MultiBarcode Mode does not support concatenated barcodes.

## Scanning Considerations

Typically, scanning is a simple matter of aim, scan, and decode, with a few quick trial efforts to master it.

However, consider the following to optimize scanning performance:

- Range — Scanners decode optimally over a particular working range — minimum and maximum distances from the barcode. This range varies according to barcode density and scanning device optics. Scan within range for quick and constant decodes; scanning too close or too far away prevents decodes. Move the scanner closer and further away to find the right working range for the barcodes being scanned.

- Angle — Scanning angle is important for quick decodes. When the illumination/flash reflects directly back into the imager, the specular reflection can blind/saturate the imager. To avoid this, scan the barcode so that the beam does not bounce directly back. Do not scan at too sharp an angle; the scanner needs to collect scattered reflections from the scan to make a successful decode. Practice quickly shows what tolerances to work within.
- Hold the device farther away for larger symbols.
- Move the device closer for symbols with bars that are close together.



**NOTE:** Scanning procedures depend on the app and device configuration. An app may use different scanning procedures from the one listed above.

### Scanning with the Internal Imager

To read a barcode, a scan-enabled application is required. The device contains the DataWedge Demonstration (DWDemo) app, which enables the imager, decodes the barcode/QR code data, and displays barcode content.

1. Ensure that an application is open on the device, and a text field is in focus (the text cursor is in the text field).
2. Point the exit window on the top of the device at a barcode or QR code.
3. Press and hold the scan button.

The device projects the aiming pattern.

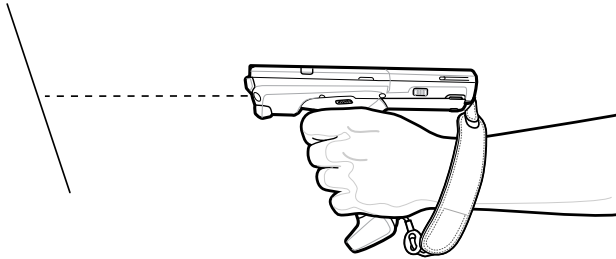

**NOTE:** Imager decoding usually occurs automatically. When the device is in Picklist mode, the imager does not decode the barcode until the red or green crosshair touches the barcode.

- Ensure that the barcode is within the area formed in the aiming pattern.

**Figure 12** Aiming Patterns

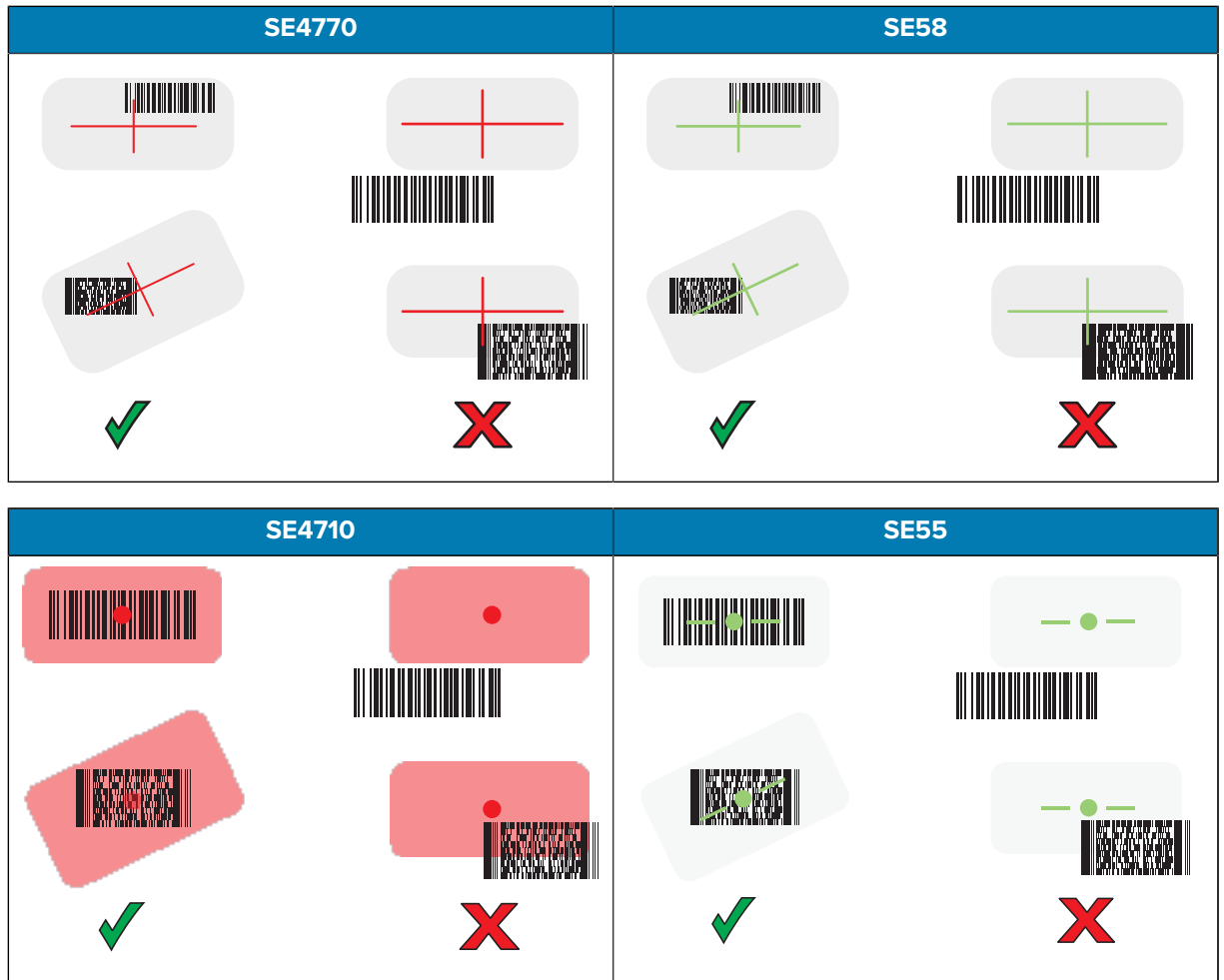

**Figure 13** Picklist Mode with Multiple Barcodes in Aiming Pattern

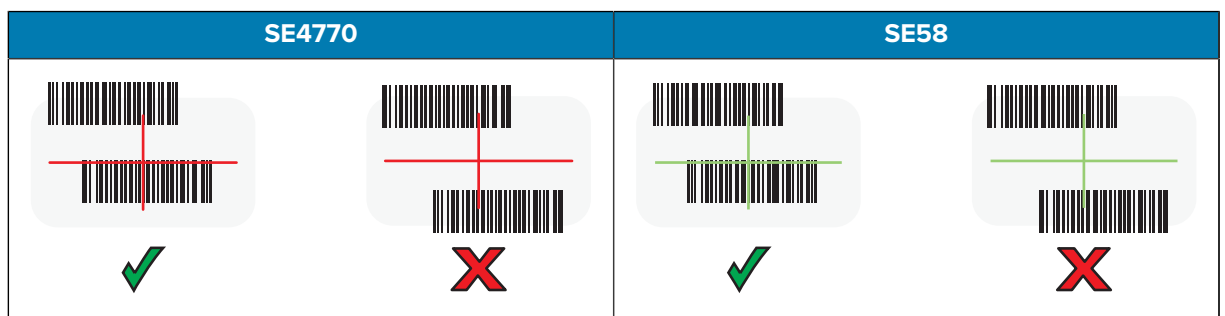

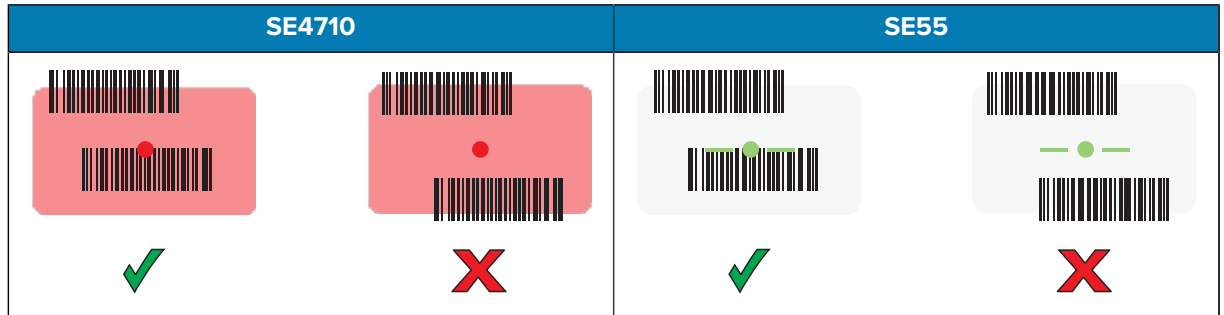

The Data Capture LED lights up, and the device beeps, by default, to indicate that the barcode was decoded successfully.



**NOTE:** The device repeats the steps required to take a digital picture (image) of a poor or difficult barcode as long as the scan button remains pressed.

5. Release the scan button.

The device displays the barcode data in the text field.

## Scanning with the RS5100 Ring Scanner

Use the RS5100 Ring Scanner to capture barcode data.

**Figure 14** RS5100 Ring Scanner

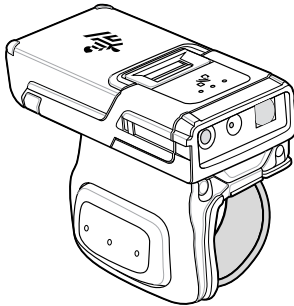

Refer to the RS5100 Ring Scanner Product Reference Guide for more information.



**NOTE:** To read a barcode, a scan-enabled app is required. The device contains the DataWedge app that allows the user to enable the scanner to decode barcode data and display the barcode content.

To scan with the RS5100:

1. Pair the RS5100 with the device.
2. Ensure that an app is open on the device and a text field is in focus (text cursor in text field).

3. Point the RS5100 at a barcode.

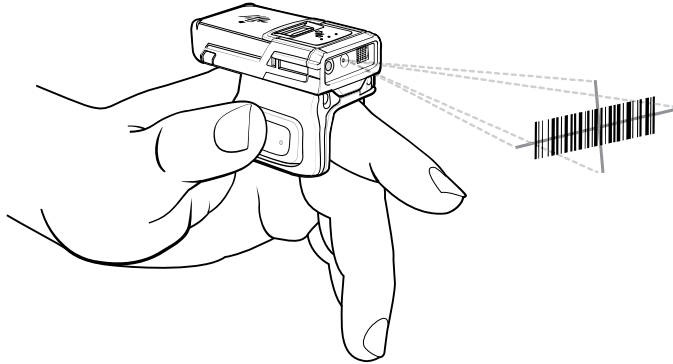

4. Press and hold the trigger.

The red laser aiming pattern turns on to assist in aiming. Ensure the barcode is within the area formed by the cross-hairs in the aiming pattern. The aiming dot increases visibility in bright lighting conditions.

**Figure 15** RS5100 Aiming Pattern

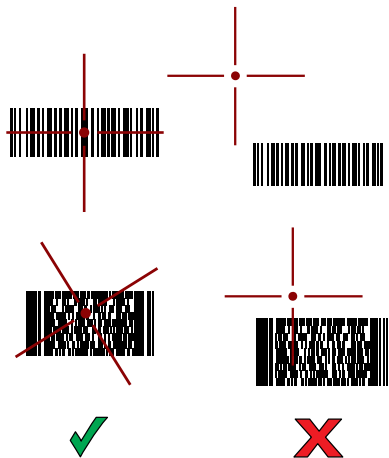

When the RS5100 is in Pick List mode, the RS5100 does not decode the barcode until the center of the crosshair touches the barcode.

**Figure 16** RS5100 Pick List Mode with Multiple Barcodes in Aiming Pattern



The RS5100 LEDs light green and a beep sounds to indicate the barcode was decoded successfully. The captured data appears in the text field.

## Scanning with the RS6000 Bluetooth Ring Scanner

Use the RS6000 Bluetooth Ring Scanner to capture barcode data.

**Figure 17** RS6000 Bluetooth Ring Scanner

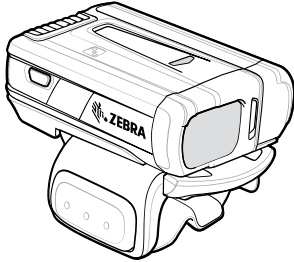

Refer to the RS6000 Bluetooth Ring Scanner Product Reference Guide for more information.



**NOTE:** To read a barcode, a scan-enabled app is required. The device contains the DataWedge app that enables the user to use the scanner to decode barcode data and display the barcode content.

To scan with the RS6000:

1. Pair the RS6000 with the device.
2. Ensure that an app is open on the device and a text field is in focus (text cursor in text field).
3. Point the RS6000 at a barcode.

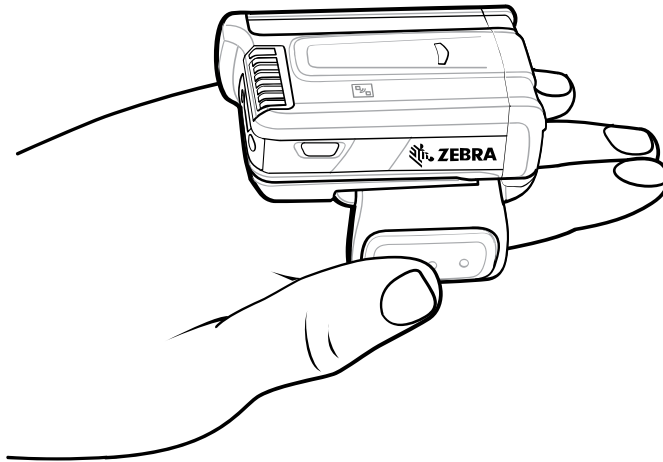

**4.** Press and hold the trigger.

The red laser aiming pattern turns on to assist in aiming. Ensure the barcode is within the area formed by the cross-hairs in the aiming pattern. The aiming dot increases visibility in bright lighting conditions.

**Figure 18** RS6000 Aiming Pattern

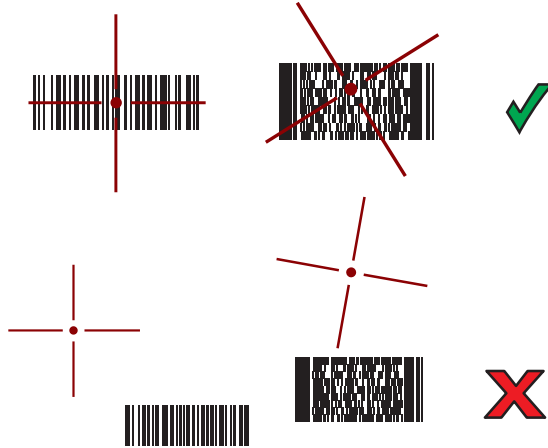

When the RS6000 is in Pick List mode, the RS6000 does not decode the barcode until the center of the crosshair touches the barcode.

**Figure 19** RS6000 Pick List Mode with Multiple Barcodes in Aiming Pattern



The RS6000 LEDs light green and a beep sounds to indicate the barcode was decoded successfully. The captured data appears in the text field.



## Scanning with the DS3678 Bluetooth Scanner

Use the DS3678 Bluetooth Scanner to capture barcode data.

**Figure 20** DS3678 Digital Scanner

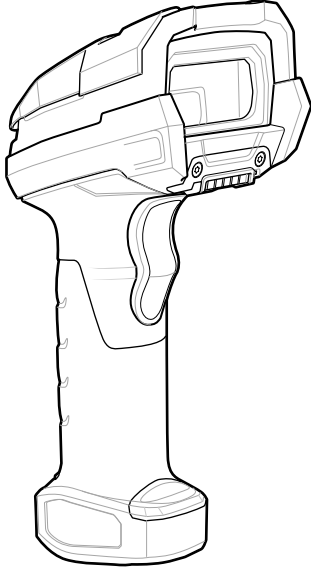

Refer to the DS3678 Product Reference Guide for more information.



**NOTE:** To read a barcode, a scan-enabled app is required. The device contains the DataWedge app that allows the user to enable the scanner to decode barcode data and display the barcode content.

To scan with the DS3678 scanner:

1. Pair the scanner with the device. See [Pairing Bluetooth Scanners](#) for more information.
2. Ensure that an app is open on the device and a text field is in focus (text cursor in text field).
3. Point the scanner at a barcode.

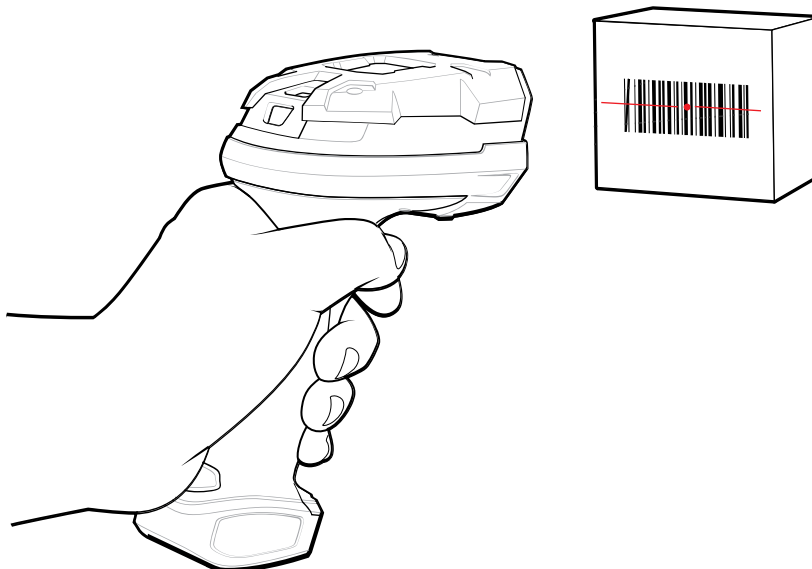

## 4. Press and hold the trigger.

Ensure the barcode is within the area formed by the aiming pattern. The aiming dot increases visibility in bright lighting conditions.

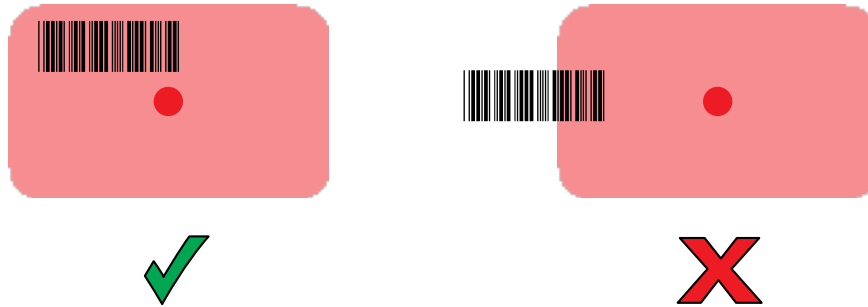

The captured data appears in the text field.

## Scanning with the DS2278 Digital Scanner

Use the DS2278 Digital Scanner to capture barcode data.

**Figure 21** DS2278 Digital Scanner



Refer to the DS2278 Digital Scanner Product Reference Guide for more information.



**NOTE:** To read a barcode, a scan-enabled app is required. The device contains the DataWedge app that allows the user to enable the scanner to decode barcode data and display the barcode content.

To scan with the DS2278:

1. Pair the DS2278 with the device. See [Pairing a Bluetooth Scanner](#) for more information.
2. Ensure that an app is open on the device and a text field is in focus (text cursor in text field).

3. Point the scanner at a barcode.

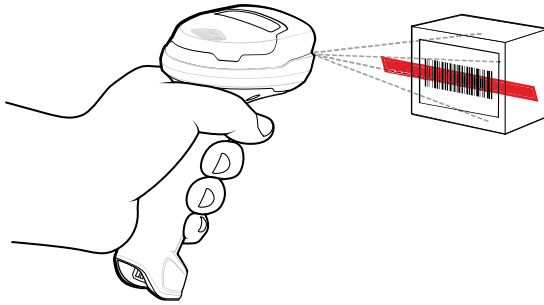

4. Press and hold the trigger.
5. Ensure the aiming pattern covers the barcode.



6. Upon successful decode, the scanner beeps and the LED flashes, and the scan line turns off. The captured data appears in the text field.

## Scanning with the DS8178 Bluetooth Scanner

Use the DS8178 Bluetooth Scanner to capture barcode data.

Refer to the DS8178 Product Reference Guide for more information.



**NOTE:** To read a barcode, a scan-enabled app is required. The device contains the DataWedge app that allows the user to enable the scanner to decode barcode data and display the barcode content.

To scan with the DS8178 scanner:

1. Pair the scanner with the device. See [Pairing Bluetooth Scanners](#) for more information.
2. Ensure that an app is open on the device and a text field is in focus (text cursor in text field).

3. Point the scanner at a barcode.

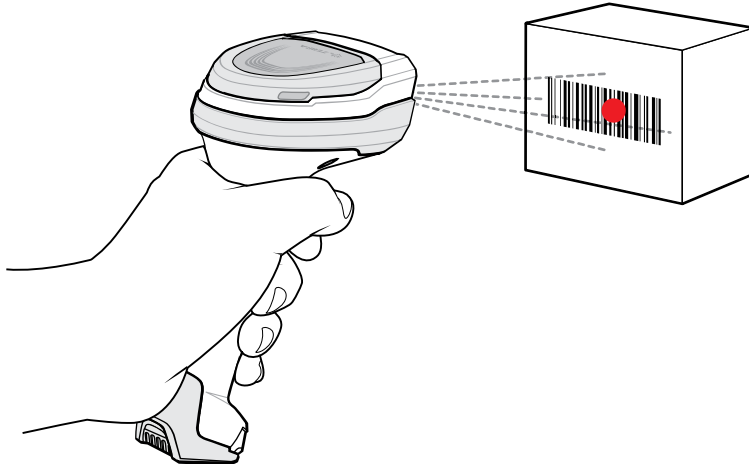

4. Press and hold the trigger.
5. Ensure the barcode is within the area formed by the aiming pattern. The aiming dot increases visibility in bright lighting conditions.

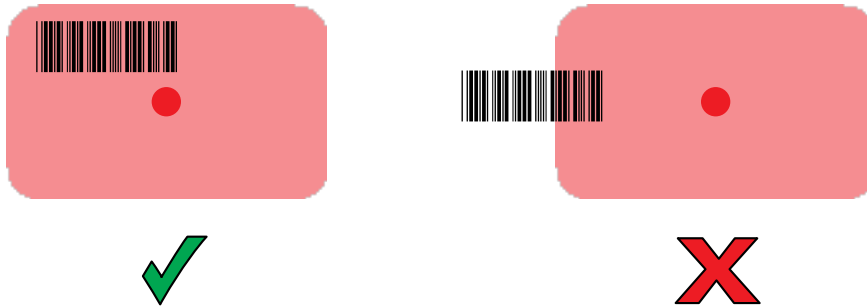

6. Upon successful decode, the scanner beeps, and the LED flashes. The captured data appears in the text field.

## Scanning with the LI3678 Linear Imager

Use the LI3678 linear imager to capture barcode data.

**Figure 22** LI3678 Bluetooth Scanner

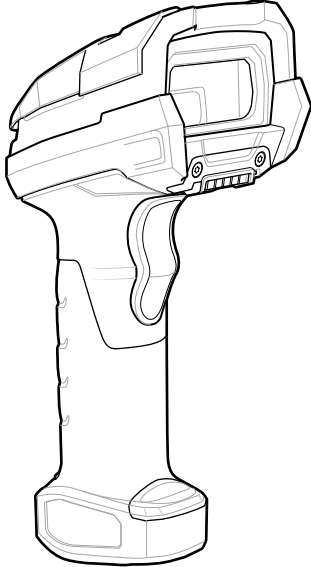

Refer to the LI3678 Product Reference Guide for more information.



**NOTE:** To read a barcode, a scan-enabled app is required. The device contains the DataWedge app that allows the user to enable the scanner to decode barcode data and display the barcode content.

To scan with the LI3678:

1. Pair the LI3678 with the device. See [Pairing a Bluetooth Scanner](#) for more information.
2. Ensure that an app is open on the device and a text field is in focus (text cursor in text field).
3. Point the LI3678 at a barcode.
4. Press and hold the trigger.

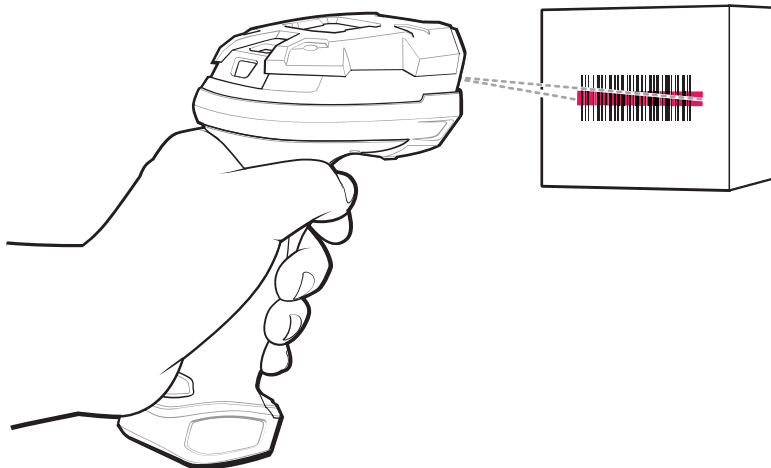

5. Ensure the aiming pattern covers the barcode.

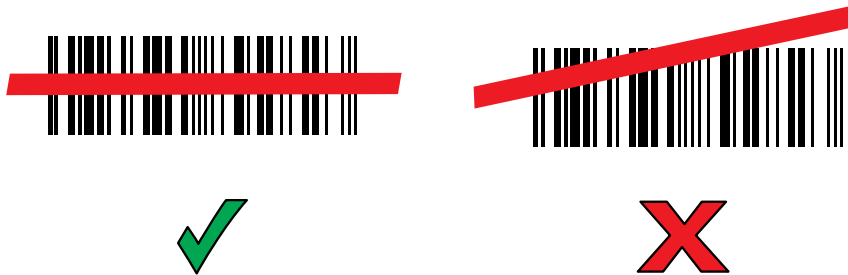

Upon successful decode, the scanner beeps and the LED displays a single green flash.  
The captured data appears in the text field.

## Pairing a Bluetooth Ring Scanner

Before using a Bluetooth Ring Scanner with the device, connect the device to the Ring Scanner.

To connect the Ring Scanner to the device, use one of the following methods:

- Near Field Communication (NFC)
- Simple Serial Interface (SSI)
- Bluetooth Human Interface Device (HID) Mode

### Pairing in SSI Mode Using Near Field Communication

The device can pair NFC-capable ring scanners in Simple Serial Interface (SSI) Mode using NFC.

1. Ensure the Ring Scanner is in SSI mode.
2. Ensure that NFC is enabled on the device.
3. Align the NFC icon (1) on the Ring Scanner with the NFC icon on the front of the device.

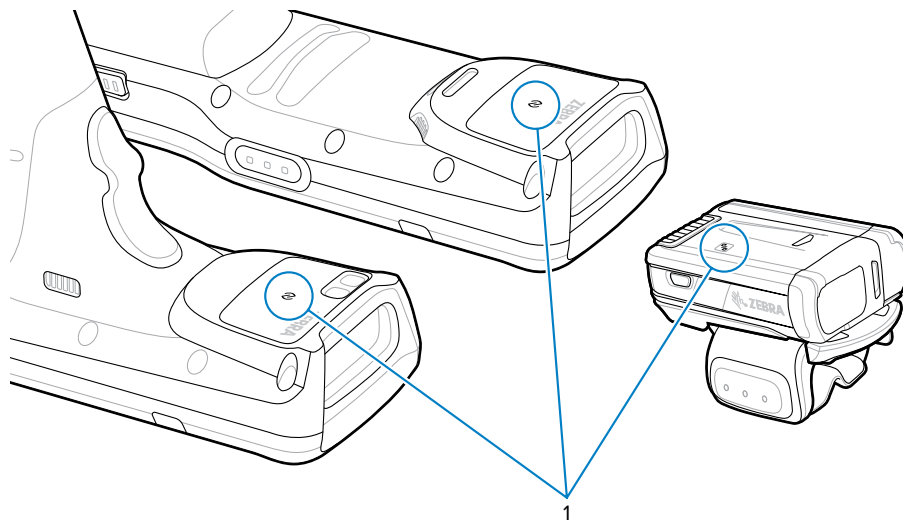

The Status LED blinks blue, indicating that the Ring Scanner is attempting to establish a connection with the device. When a connection is established, the Status LED turns off, and the Ring Scanner emits a single string of low/high beeps.

A notification appears on the device screen and the  displays in the Status bar.

## Pairing in HID Mode Using Near Field Communication

The device can pair NFC-capable ring scanners in Human Interface Device (HID) Mode using NFC.



**NOTE:** NFC is supported on the premium configurations of the device. Not all Zebra devices support NFC readers and the Tap-to-Pair feature.

1. Ensure that NFC is enabled on the device.
2. Ensure that Bluetooth is enabled on both devices.
3. Ensure that the Bluetooth device to discover is in discoverable mode.
4. Ensure that the two devices are within 10 meters (32.8 feet) of one another.
5. Place the Ring Scanner in Human Interface Device (HID) mode. If the Ring Scanner is already in HID mode, skip to step 6.
  - a) Remove the battery from the Ring Scanner.
  - b) Press and hold the Restore key.
  - c) Install the battery onto the Ring Scanner.
  - d) Keep holding the Restore key for about five seconds until a chirp is heard and the Scan LEDs flash green.
  - e) Scan the barcode below to place the Ring Scanner in HID mode.

**Figure 23** Bluetooth HID Barcode

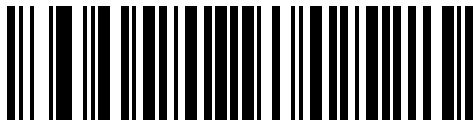

6. Remove the battery from the Ring Scanner.
7. Re-install the battery into the Ring Scanner.

- Align the NFC icon (1) on the Ring Scanner with the NFC icon (1) the device.

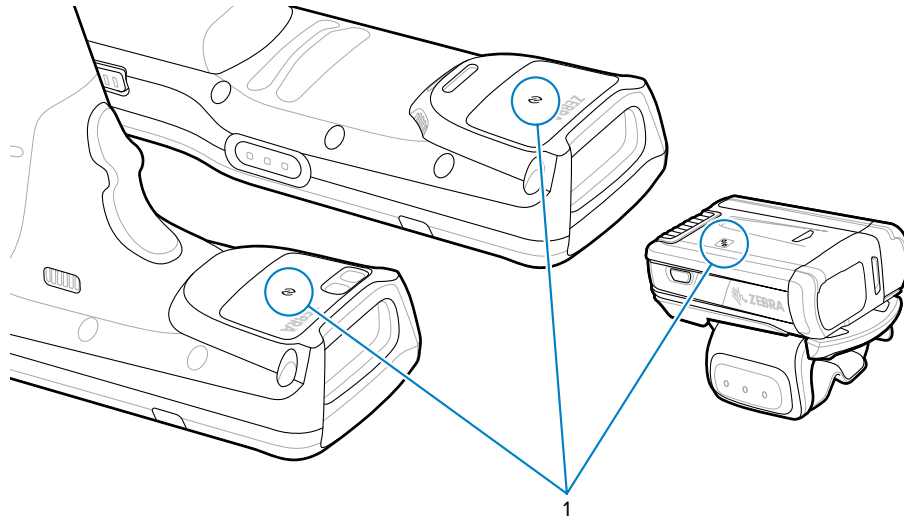

The Status LED blinks blue, indicating that the Ring Scanner is attempting to establish a connection with the device. When a connection is established, the Status LED turns off, and the Ring Scanner emits a single string of low/high beeps.

A notification appears on the device screen and the **A** appears in the Status bar.

## Pairing Using Simple Serial Interface (SSI)

Pair the Ring Scanner to the device using Simple Serial Interface.

- Swipe up from the bottom of the Home screen and touch .
- Using the Ring Scanner, scan the barcode on the screen.

The Ring Scanner emits a string of high/low/high/low beeps. The Scan LED flashes green indicating that the Ring Scanner is attempting to establish a connection with the device. When a connection is established, the Scan LED turns off and the Ring Scanner emits one string of low/high beeps.

A notification appears on the Notification panel and the  icon appears in the Status bar.

## Pairing the Ring Scanner Using Bluetooth Human Interface Device

Pair the Ring Scanner to the device using Human Interface Device (HID).

- Ensure that Bluetooth is enabled on both devices.
- Ensure that the Bluetooth device to discover is in discoverable mode.
- Ensure that the two devices are within 10 m (32.8 ft) of one another.



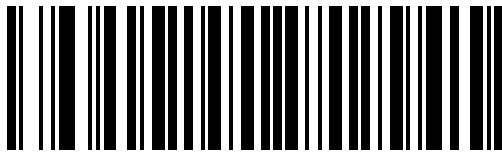

4. Place the Ring Scanner in HID mode. If the Ring Scanner is already in HID mode, skip to step 5.
  - a) Remove the battery from the Ring Scanner.
  - b) Press and hold **Restore**.
  - c) Install the battery onto the Ring Scanner.
  - d) Keep holding the Restore key for about five seconds until a chirp is heard and the Scan LEDs flash green.
  - e) Scan the barcode below to place the Ring Scanner in HID mode.

**Figure 24** RS507 Bluetooth HID Barcode

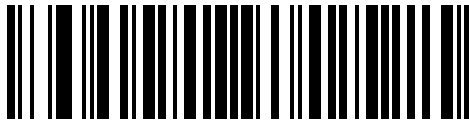

**Figure 25** RS6000 Bluetooth HID Barcode



5. Remove the battery from the Ring Scanner.
6. Re-install the battery into the Ring Scanner.
7. Swipe down from the Status bar to open the Quick Access panel and then touch .
8. Touch **Bluetooth**.
9. Touch **Pair new device**. The device begins searching for discoverable Bluetooth devices in the area and displays them under **Available devices**.
10. Scroll through the list and select Ring Scanner.

The device connects to the Ring Scanner and **Connected** appears below the device name. The Bluetooth device is added to the **Paired devices** list and a trusted (“paired”) connection is established.

A notification appears on the Notification panel and the  icon appears in the Status bar.

## Pairing a Bluetooth Scanner

Before using a Bluetooth scanner with the device, connect the device to the Bluetooth scanner.

Connect the scanner to the device using one of the following methods:

- Simple Serial Interface (SSI) mode
- Bluetooth Human Interface Device (HID) mode

### Pairing the Bluetooth Scanner Using Simple Serial Interface (SSI)

Pair the scanner with the device using SSI.

1. Ensure that the two devices are within 10 meters (32.8 feet) of one another.

2. Install the battery into the scanner.
3. Swipe up from the bottom of the Home screen and touch .

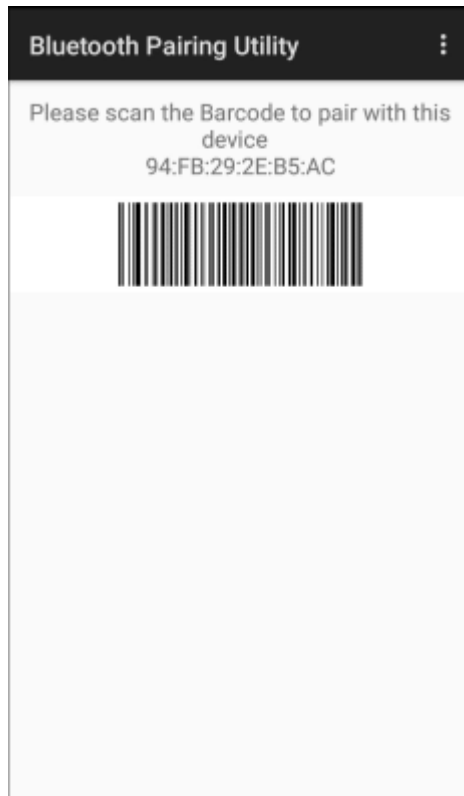

4. Using the scanner, scan the barcode on the screen.

The scanner emits a string of high/low/high/low beeps. The Scan LED flashes green indicating that the scanner is attempting to establish a connection with the device. When a connection is established, the Scan LED turns off and the scanner emits one string of low/high beeps

A notification displays and the  icon appears in the Status bar.

## Pairing Using Bluetooth Human Interface Device

Pair the Bluetooth scanner to the device using HID.

To pair the scanner with the device using HID:

1. Remove the battery from the scanner.
2. Replace the battery.
3. After the scanner reboots, scan the barcode below to place the scanner in HID mode.

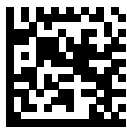

4. On the device, swipe down from the Status bar to open the Quick Access panel and then touch .
5. Touch **Bluetooth**.

6. Touch **Pair new device**. The device begins searching for discoverable Bluetooth devices in the area and displays them under **Available devices**.
7. Scroll through the list and select XXXXX xxxxxx, where XXXXX is the scanner and xxxxxx is the serial number.

The device connects to the scanner, the scanner beeps once and **Connected** appears below the device name. The Bluetooth device is added to the **Paired devices** list and a trusted (paired) connection is established.

## DataWedge

DataWedge is a utility that adds advanced barcode scanning capability to any application without writing code. It runs in the background and handles the interface to built-in barcode scanners. The captured barcode data is converted to keystrokes and sent to the target application as if it was typed on the keypad.

DataWedge allows any app on the device to get data from input sources such as a barcode scanner, MSR, RFID, voice, or serial port and manipulate the data based on options or rules.



Configure DataWedge to:

- Provide data capture services from any app.
- Use a particular scanner, reader, or other peripheral devices.
- Properly format and transmit data to a specific app.

To configure DataWedge, refer to [techdocs.zebra.com/datawedge/](http://techdocs.zebra.com/datawedge/).

## Enabling DataWedge



This procedure provides information on how to enable DataWedge on the device.

1. Swipe up from the bottom of the Home screen and touch .
2. Touch  > **Settings**.
3. Touch the **DataWedge enabled** checkbox.

A blue checkmark appears in the checkbox indicating that DataWedge is enabled.

## Disabling DataWedge

This procedure provides information on how to disable DataWedge on the device.

1. Swipe up from the bottom of the Home screen and touch .
2. Touch .
3. Touch **Settings**.
4. Touch **DataWedge enabled**.

## Supported Decoders

This sections provides the supported decoders for each data capture option.

### Camera Supported Decoders

This section lists the supported decoders for the internal camera.

**Table 9** Camera-Supported Decoders

Decoder	Default State	Decoder	Default State	Decoder	Default State
Australian Postal	O	EAN8	X	MSI	O
Aztec	X	Grid Matrix	O	PDF417	X
Canadian Postal	O	GS1 DataBar	X	QR Code	X
Chinese 2 of 5	O	GS1 DataBar Expanded	X	Decoder Signature	O
Codabar	X	GS1 DataBar Limited	O	TLC 39	O
Code 11	O	GS1 Datamatrix	O	Trioptic 39	O
Code 128	X	GS1 QRCode	O	UK Postal	O
Code 39	X	HAN XIN	O	UPCA	X
Code 93	O	Interleaved 2 of 5	O	UPCE0	X
Composite AB	O	Japanese Postal	O	UPCE1	O
Composite C	O	Korean 3 of 5	O	US4state	O
Discrete 2 of 5	O	MAIL MARK	X	US4state FICS	O
Datamatrix	X	Matrix 2 of 5	O	US Planet	O
Dutch Postal	O	Maxicode	X	US Postnet	O
DotCode	X	MicroPDF	O		
EAN13	X	MicroQR	O		

Key: X = Enabled, O = Disabled, - = Not Supported

### SE55 Internal Imager Supported Decoders

This section lists the supported decoders for the SE55 internal imager.

**Table 10** SE55 Internal Imager-Supported Decoders

Decoder	Default State	Decoder	Default State	Decoder	Default State
Australian Postal	O	EAN8	X	MSI	O

**Table 10** SE55 Internal Imager-Supported Decoders (Continued)

Decoder	Default State	Decoder	Default State	Decoder	Default State
Aztec	X	Grid Matrix	O	PDF417	X
Canadian Postal	O	GS1 DataBar	X	QR Code	X
Chinese 2 of 5	O	GS1 DataBar Expanded	X	Decoder Signature	O
Codabar	X	GS1 DataBar Limited	O	TLC 39	O
Code 11	O	GS1 Datamatrix	O	Trioptic 39	O
Code 128	X	GS1 QRCode	O	UK Postal	O
Code 39	X	HAN XIN	O	UPCA	X
Code 93	O	Interleaved 2 of 5	O	UPCE0	X
Composite AB	O	Japanese Postal	O	UPCE1	O
Composite C	O	Korean 3 of 5	O	US4state	O
Discrete 2 of 5	O	MAIL MARK	X	US4state FICS	O
Datamatrix	X	Matrix 2 of 5	O	US Planet	O
Dutch Postal	O	Maxicode	X	US Postnet	O
DotCode	O	MicroPDF	O		
EAN13	X	MicroQR	O		

## SE58 Internal Imager Supported Decoders

This section lists the supported decoders for the SE58 internal imager.

**Table 11** SE58 Internal Imager Supported Decoders

Decoder	Default State	Decoder	Default State	Decoder	Default State
Australian Postal	X	EAN8	X	MSI	O
Aztec	X	Grid Matrix	O	PDF417	X
Canadian Postal	O	GS1 DataBar	X	QR Code	X
Chinese 2 of 5	O	GS1 DataBar Expanded	X	Decoder Signature	O
Codabar	O	GS1 DataBar Limited	X	TLC 39	O
Code 11	O	GS1 Datamatrix	O	Trioptic 39	O
Code 128	X	GS1 QRCode	O	UK Postal	X
Code 39	X	HAN XIN	O	UPCA	X

**Table 11** SE58 Internal Imager Supported Decoders (Continued)

Decoder	Default State	Decoder	Default State	Decoder	Default State
Code 93	O	Interleaved 2 of 5	O	UPCE0	X
Composite AB	O	Japanese Postal	X	UPCE1	X
Composite C	O	Korean 3 of 5	O	US4state	O
Discrete 2 of 5	O	MAIL MARK	O	US4state FICS	O
Datamatrix	X	Matrix 2 of 5	O	US Planet	O
Dutch Postal	O	Maxicode	X	US Postnet	O
DotCode	O	MicroPDF	O		
EAN13	X	MicroQR	X		

Key: X = Enabled, O = Disabled, - = Not Supported

## SE4710 Internal Imager Supported Decoders

This section lists the supported decoders for the SE4710 internal imager.

**Table 12** Internal Imager SE4710 Supported Decoders

Decoder	Default State	Decoder	Default State	Decoder	Default State
Australian Postal	O	EAN8	X	MSI	O
Aztec	X	Grid Matrix	O	PDF417	X
Canadian Postal	O	GS1 DataBar	X	QR Code	X
Chinese 2 of 5	O	GS1 DataBar Expanded	X	Decoder Signature	O
Codabar	X	GS1 DataBar Limited	O	TLC 39	O
Code 11	O	GS1 Datamatrix	O	Trioptic 39	O
Code 128	X	GS1 QRCode	O	UK Postal	O
Code 39	X	HAN XIN	O	UPCA	X
Code 93	O	Interleaved 2 of 5	O	UPCE0	X
Composite AB	O	Japanese Postal	O	UPCE1	O
Composite C	O	Korean 3 of 5	O	US4state	O
Discrete 2 of 5	O	MAIL MARK	X	US4state FICS	O
Datamatrix	X	Matrix 2 of 5	O	US Planet	O
Dutch Postal	O	Maxicode	X	US Postnet	O

**Table 12** Internal Imager SE4710 Supported Decoders (Continued)

Decoder	Default State	Decoder	Default State	Decoder	Default State
DotCode	O	MicroPDF	O		
EAN13	X	MicroQR	O		

Key: X = Enabled, O = Disabled, - = Not Supported

## SE4770 Internal Imager Supported Decoders

This section lists the supported decoders for the SE4770 internal imager.

**Table 13** SE4770 Internal Imager-Supported Decoders

Decoder	Default State	Decoder	Default State	Decoder	Default State
Australian Postal	O	EAN8	X	MSI	O
Aztec	X	Grid Matrix	O	PDF417	X
Canadian Postal	O	GS1 DataBar	X	QR Code	X
Chinese 2 of 5	O	GS1 DataBar Expanded	X	Decoder Signature	O
Codabar	X	GS1 DataBar Limited	O	TLC 39	O
Code 11	O	GS1 Datamatrix	O	Trioptic 39	O
Code 128	X	GS1 QRCode	O	UK Postal	O
Code 39	X	HAN XIN	O	UPCA	X
Code 93	O	Interleaved 2 of 5	O	UPCE0	X
Composite AB	O	Japanese Postal	O	UPCE1	O
Composite C	O	Korean 3 of 5	O	US4state	O
Discrete 2 of 5	O	MAIL MARK	X	US4state FICS	O
Datamatrix	X	Matrix 2 of 5	O	US Planet	O
Dutch Postal	O	Maxicode	X	US Postnet	O
DotCode	O	MicroPDF	O		
EAN13	X	MicroQR	O		

Key: X = Enabled, O = Disabled, - = Not Supported

## RS5100 Supported Decoders

This section lists the supported decoders for the RS5100 Ring Scanner.

**Table 14** RS5100-Supported Decoders

Decoder	Default State	Decoder	Default State	Decoder	Default State
Australian Postal	O	EAN8	X	MSI	O
Aztec	X	Grid Matrix	O	PDF417	X
Canadian Postal	O	GS1 DataBar	X	QR Code	X
Chinese 2 of 5	O	GS1 DataBar Expanded	X	Decoder Signature	O
Codabar	X	GS1 DataBar Limited	O	TLC 39	O
Code 11	O	GS1 Datamatrix	O	Trioptic 39	O
Code 128	X	GS1 QRCode	O	UK Postal	O
Code 39	X	HAN XIN	O	UPCA	X
Code 93	O	Interleaved 2 of 5	O	UPCE0	X
Composite AB	O	Japanese Postal	O	UPCE1	O
Composite C	O	Korean 3 of 5	O	US4state	O
Discrete 2 of 5	O	MAIL MARK	X	US4state FICS	O
Datamatrix	X	Matrix 2 of 5	O	US Planet	O
Dutch Postal	O	Maxicode	X	US Postnet	O
DotCode	O	MicroPDF	O		
EAN13	X	MicroQR	O		

Key: X = Enabled, O = Disabled, - = Not Supported

## RS6000 Supported Decoders

This section lists the supported decoders for the RS6000 Ring Scanner.

**Table 15** RS6000-Supported Decoders

Decoder	Default State	Decoder	Default State	Decoder	Default State
Australian Postal	O	EAN8	X	MSI	O
Aztec	X	Grid Matrix	O	PDF417	X
Canadian Postal	O	GS1 DataBar	X	QR Code	X



**Table 15** RS6000-Supported Decoders (Continued)

Decoder	Default State	Decoder	Default State	Decoder	Default State
Chinese 2 of 5	O	GS1 DataBar Expanded	X	Decoder Signature	O
Codabar	X	GS1 DataBar Limited	O	TLC 39	O
Code 11	O	GS1 Datamatrix	O	Trioptic 39	O
Code 128	X	GS1 QRCode	O	UK Postal	O
Code 39	X	HAN XIN	O	UPCA	X
Code 93	O	Interleaved 2 of 5	O	UPCE0	X
Composite AB	O	Japanese Postal	O	UPCE1	O
Composite C	O	Korean 3 of 5	O	US4state	O
Discrete 2 of 5	O	MAIL MARK	X	US4state FICS	O
Datamatrix	X	Matrix 2 of 5	O	US Planet	O
Dutch Postal	O	Maxicode	X	US Postnet	O
DotCode	O	MicroPDF	O		
EAN13	X	MicroQR	O		

Key: X = Enabled, O = Disabled, - = Not Supported

## DS3678 Supported Decoders

This section lists the supported decoders for the DS3678 scanner.

**Table 16** DS3678-Supported Decoders

Decoder	Default State	Decoder	Default State	Decoder	Default State
Australian Postal	O	EAN8	X	MSI	O
Aztec	X	Grid Matrix	O	PDF417	X
Canadian Postal	—	GS1 DataBar	X	QR Code	X
Chinese 2 of 5	O	GS1 DataBar Expanded	X	Decoder Signature	—
Codabar	X	GS1 DataBar Limited	O	TLC 39	O
Code 11	O	GS1 Datamatrix	O	Trioptic 39	O
Code 128	X	GS1 QRCode	O	UK Postal	O
Code 39	X	HAN XIN	O	UPCA	X

**Table 16** DS3678-Supported Decoders (Continued)

Decoder	Default State	Decoder	Default State	Decoder	Default State
Code 93	O	Interleaved 2 of 5	O	UPCE0	X
Composite AB	O	Japanese Postal	O	UPCE1	O
Composite C	O	Korean 3 of 5	O	US4state	O
Discrete 2 of 5	O	MAIL MARK	X	US4state FICS	O
Datamatrix	X	Matrix 2 of 5	O	US Planet	O
Dutch Postal	O	Maxicode	X	US Postnet	O
DotCode	O	MicroPDF	O		
EAN13	X	MicroQR	O		

Key: X = Enabled, O = Disabled, — = Not Supported

## DS2278 Supported Decoders

This section lists the supported decoders for the DS2278 Digital Scanner.

**Table 17** DS2278 Digital Scanner-Supported Decoders

Decoder	Default State	Decoder	Default State	Decoder	Default State
Australian Postal	O	EAN8	X	MSI	O
Aztec	X	Grid Matrix	O	PDF417	X
Canadian Postal	—	GS1 DataBar	X	QR Code	X
Chinese 2 of 5	O	GS1 DataBar Expanded	X	Decoder Signature	O
Codabar	X	GS1 DataBar Limited	O	TLC 39	O
Code 11	O	GS1 Datamatrix	O	Trioptic 39	O
Code 128	X	GS1 QRCode	O	UK Postal	O
Code 39	X	HAN XIN	—	UPCA	X
Code 93	O	Interleaved 2 of 5	O	UPCE0	X
Composite AB	O	Japanese Postal	O	UPCE1	O
Composite C	O	Korean 3 of 5	O	US4state	O
Discrete 2 of 5	O	MAIL MARK	X	US4state FICS	O
Datamatrix	X	Matrix 2 of 5	O	US Planet	O
Dutch Postal	O	Maxicode	X	US Postnet	O

**Table 17** DS2278 Digital Scanner-Supported Decoders (Continued)

Decoder	Default State	Decoder	Default State	Decoder	Default State
DotCode	O	MicroPDF	O		
EAN13	X	MicroQR	O		

Key: X = Enabled, O = Disabled, — = Not Supported

## DS8178 Supported Decoders

This section lists the supported decoders for the DS8178 Digital scanner.

**Table 18** DS8178 Digital Scanner-Supported Decoders

Decoder	Default State	Decoder	Default State	Decoder	Default State
Australian Postal	O	EAN8	X	MSI	O
Aztec	X	Grid Matrix	O	PDF417	X
Canadian Postal	—	GS1 DataBar	X	QR Code	X
Chinese 2 of 5	O	GS1 DataBar Expanded	X	Decoder Signature	—
Codabar	X	GS1 DataBar Limited	O	TLC 39	O
Code 11	O	GS1 Datamatrix	O	Trioptic 39	O
Code 128	X	GS1 QRCode	O	UK Postal	O
Code 39	X	HAN XIN	—	UPCA	X
Code 93	O	Interleaved 2 of 5	O	UPCE0	X
Composite AB	O	Japanese Postal	O	UPCE1	O
Composite C	O	Korean 3 of 5	O	US4state	O
Discrete 2 of 5	O	MAIL MARK	X	US4state FICS	O
Datamatrix	X	Matrix 2 of 5	O	US Planet	O
Dutch Postal	O	Maxicode	X	US Postnet	O
DotCode	O	MicroPDF	O		
EAN13	X	MicroQR	O		

Key: X = Enabled, O = Disabled, — = Not Supported

## LI3678 Supported Decoders

This section lists the supported decoders for the LI3678 scanner.

**Table 19** LI3678-Supported Decoders

Decoder	Default State	Decoder	Default State	Decoder	Default State
Australian Postal	—	EAN8	X	MSI	O
Aztec	—	Grid Matrix	O	PDF417	—
Canadian Postal	—	GS1 DataBar	X	QR Code	—
Chinese 2 of 5	O	GS1 DataBar Expanded	X	Decoder Signature	—
Codabar	X	GS1 DataBar Limited	O	TLC 39	O
Code 11	O	GS1 Datamatrix	—	Trioptic 39	O
Code 128	X	GS1 QRCode	—	UK Postal	—
Code 39	X	HAN XIN	O	UPCA	X
Code 93	O	Interleaved 2 of 5	O	UPCE0	X
Composite AB	—	Japanese Postal	—	UPCE1	O
Composite C	—	Korean 3 of 5	O	US4state	—
Discrete 2 of 5	O	MAIL MARK	—	US4state FICS	—
Datamatrix	—	Matrix 2 of 5	O	US Planet	—
Dutch Postal	—	Maxicode	—	US Postnet	—
DotCode	O	MicroPDF	—		
EAN13	X	MicroQR	—		

Key: X = Enabled, O = Disabled, — = Not Supported

# Wireless

This section provides information on the wireless features of the device.

The following wireless features are available on the device:

- Wireless Local Area Network (WLAN)
- Wireless Wide Area Network (WWAN)
- Bluetooth
- Cast
- Near Field Communication (NFC)

## Wireless Local Area Network

Wireless local area networks (WLANs) allow the device to communicate wirelessly inside a building. Before using the device on a WLAN, the facility must be set up with the required hardware to run the WLAN (sometimes known as infrastructure). The infrastructure and the device must both be properly configured to enable this communication.



**NOTE:** To extend the life of the battery, turn off Wi-Fi when not in use.

Refer to the documentation provided with the infrastructure [access points (APs), access ports, switches, Radius servers, etc.] on set up. When the infrastructure is set up to enforce the chosen WLAN security scheme, use the **Network & internet** settings to configure the device to match the security scheme.

## Removing a Wi-Fi Network

This section describes how to remove a Wi-Fi network

1. Go to **Settings**.
2. Touch **Network & internet > Internet**.
3. Scroll down to the bottom of the list and touch **Saved networks**.
4. Touch the name of the network.
5. Touch **FORGET**.

The device automatically disconnects from the Wi-Fi network.

## Connecting to a Wi-Fi Network

This section describes how to connect to a Wi-Fi network.

1. Go to **Settings**.
2. Touch **Network & internet > Internet**.  
The **Internet** screen displays, and the device searches for WLANs in the area and lists them.
3. Scroll through the list and select the desired WLAN network.
4. For open networks, touch the profile (or press and hold) and select **Connect**. For secure networks, enter the required password or other credentials and then touch **Connect**. See the system administrator for more information.

The device obtains a network address and other required information from the network using the dynamic host configuration protocol (DHCP) protocol. To configure the device with a fixed internet protocol (IP) address, see [Configuring the Device to Use a Static IP Address](#).

In the Wi-Fi setting field, **Connected** displays, indicating that the device is connected to the WLAN.

## WLAN Configuration

This section provides information on configuring Wi-Fi settings.

### Configuring a Secure Wi-Fi Network

1. Go to **Settings**.
2. Touch **Network & internet > Internet**.
3. Turn on the **Wi-Fi** switch.  
The device searches for WLANs in the area and lists them on the screen.
4. Scroll through the list and select the desired WLAN network.
5. Touch the desired network. If network security is **None**, the device automatically connects to the network. For all other network security, a dialog box appears.
6. If network security is **WPA/WPA2-Personal**, **WPA3-Personal**, or **WEP**, enter the required password, and then touch **Connect**.

7. If network security is **WPA/WPA2/WPA3 Enterprise**:

a) Touch the **EAP method** drop-down list and select one of the following:

- **PEAP**
- **TLS**
- **TTLS**
- **PWD**
- **SIM**
- **AKA**
- **AKA'**
- **LEAP**

b) Fill in the appropriate information. Options vary depending on the **EAP method** chosen.

- When selecting **CA certificate**, Certification Authority (CA) certificates are installed using the **Security** settings.
- When using the EAP methods PEAP, TLS, or TTLS, specify a domain.
- Touch **Advanced options** to display additional network options.

### Configuring the Device to Use a Static IP Address

By default, the device is configured to use Dynamic Host Configuration Protocol (DHCP) to assign an Internet protocol (IP) address when connecting to a wireless network.

1. Go to **Settings**.
2. Touch **Network & internet > Internet**.
3. Slide the Wi-Fi switch to the **On** position.
4. In the network dialog box, select and touch a network.
5. If you are configuring the connected network, touch  to edit the network details and then touch the down arrow to hide the keyboard.
6. Touch **Advanced options**.
7. Touch **IP settings** and select **Static**.
8. In the **IP address** text box, enter an IP address for the device.
9. If required:
  - In the **Gateway** text box, enter a gateway address for the device.
  - In the **Network prefix length** text box, enter the prefix length.
  - In the **DNS 1** text box, enter a Domain Name System (DNS) address.
  - In the **DNS 2** text box, enter a DNS address.
10. If you are configuring the connected network, touch **Save** otherwise, touch **Connect**.

## Wi-Fi Preferences

Use the Wi-Fi preferences to configure advanced Wi-Fi settings.

From the **Internet** screen, scroll down and touch **Network preferences**.

- **Turn on Wi-Fi automatically** - When enabled, Wi-Fi automatically turns back on when near high-quality saved networks.
- **Notify for public networks** - When enabled, it notifies you when a public network is available.
- **Additional settings** - Touch to view additional Wi-Fi settings. Go to [Additional Wi-Fi Settings](#) for more information.
- **Install Certificates** - Touch to install certificates.
- **Wi-Fi Direct** - Displays a list of devices available for a direct Wi-Fi connection. Go to [Wi-Fi Direct](#) for more information.

## Additional Wi-Fi Settings

Use Additional Settings to configure Wi-Fi settings.

From the **Internet** screen, scroll down and touch **Network preferences > Additional Settings**.



**NOTE:** Additional Wi-Fi settings are for the device, not for a specific wireless network.

- **Regulatory**
  - **Country Selection** - Displays the acquired country code.
  - **Region code** - Displays the current region code.
- **Band and Channel Selection**
  - **Wi-Fi frequency band** - Set the frequency band to: **Auto** (default), **5 GHz only** or **2.4 GHz only**.
  - **Available channels (2.4 GHz)** - Touch to display the **Available channels** menu. Select specific channels and touch **OK**.
  - **Available channels (5 GHz)** - Touch to display the **Available channels** menu. Select specific channels and touch **OK**.
  - **Available channels (6 GHz)** - Touch to display the **Available channels** menu. Select specific channels and touch **OK**.
- **Logging**
  - **Advanced Logging** - Touch to enable advanced logging or change the log directory.
  - **Wireless logs** - Use to capture Wi-Fi log files.
    - **Fusion Logger** - Touch to open the **Fusion Logger** application. This application maintains a history of high level WLAN events which helps to understand the status of connectivity.
    - **Fusion Status** - Touch to display live status of WLAN state. Also provides information about the device and connected profile.
- **About**
  - **Version** - Displays the current version information. Touch the version to display addition version details.



## Wi-Fi Direct

Wi-Fi Direct devices connect to each other without having to go through an access point and establish their own ad-hoc network when required. View which devices are available and choose which one you want to connect to.

To view available devices and connect to a device:

1. Go to **Settings**.
2. Touch **Network & internet > Internet**.
3. Slide the **Wi-Fi** switch to the **On** position.
4. Scroll down to the bottom of the screen and touch **Network preferences > Wi-Fi Direct**.
5. Under **Peer devices**, touch a device's name.
6. On the other device, select **Accept**.

**Connected** displays on the device. On both devices, on their respective Wi-Fi Direct screens, the other device name displays in the list.

## Wireless Wide Area Networks

Use wireless wide area networks (WWANs) to access data over a cellular network.



**NOTE:** Applies to MC3450 devices only.

This section provides information on:

- Sharing a data connection.
- Monitoring data usage.
- Changing cellular network settings.

## Sharing the Mobile Data Connection

The **Tethering & Portable Hotspot** settings allow sharing the mobile data connection with a single computer via USB tethering or Bluetooth tethering.

Share the data connection with up to eight devices at once, by turning it into a portable Wi-Fi hotspot. While the device is sharing its data connection, an icon displays at the top of the screen and a corresponding message appears in the notification list.

### Enabling USB Tethering



**NOTE:** USB tethering is not supported on computers running Mac OS. If the computer is running Windows or a recent version of Linux (such as Ubuntu), follow these instructions without any special preparation. If running a version of Windows that precedes Windows 7, or some other operating system, you may need to prepare the computer to establish a network connection via USB.

1. Connect the device to a host computer with a USB cable.

The notification **Charging this device via USB** appears in the Notifications panel.

2. Go to **Settings**.

3. Touch **Network & Internet**.
4. Touch **Hotspot & tethering**.
5. Touch the **USB tethering** switch to enable.

The host computer is now sharing the device's data connection.

To stop sharing the data connection, touch the **USB tethering** switch again or disconnect the USB cable.

### Enabling Bluetooth Tethering

Use Bluetooth tethering to share the data connection with a host computer.

1. Pair the device with the host computer.
2. Go to **Settings**.
3. Touch **Network & Internet > Hotspot & tethering**.
4. Touch the **Bluetooth tethering** switch to enable.

The host computer is now sharing the device's data connection.

To stop sharing the data connection, touch the **Bluetooth tethering** switch again.

### Configuring the Wi-Fi Hotspot

Set up a Wi-Fi hotspot on the device.

1. Go to **Settings**.
2. Touch **Networking & Internet > Hotspot & tethering**.
3. Touch **Wi-Fi hotspot**.
4. In the **Hotspot** name text field, edit the name for the hotspot.
5. Touch **Security** and select a security method from the drop-down list.
  - **WPA3-Personal, WPA2/WPA3-Personal, or WPA2-Personal**
    - a. Touch **Hotspot password**.
    - b. Enter a password.
    - c. Touch **OK**.
  - **None** - If selected, a password is not required.
6. Touch **AP Band** and select **2.4 Ghz Band** or **5.0 Ghz Band preferred**.

Select **Additional Settings** to configure the hotspot channel for the selected band, maximum number of clients, and connected clients.

- To change the Data Usage Warning & Limit, go to **Settings > Networking & Internet > Mobile network > Data Warning & Limit**.
- Select **Additional Settings** to configure the hotspot channel for the selected band, maximum number of clients, and connected clients.

## Enabling Wi-Fi Hotspot

After configuring the device as a Wi-Fi Hotspot, turn on Wi-Fi Hotspot to begin using it.

1. Go to **Settings**.
2. Touch **Networking & Internet**.
3. Touch **Hotspot & tethering**.
4. Touch **Wi-Fi hotspot**.
5. Toggle the switch to enable.

After a moment, the device starts broadcasting its Wi-Fi network name (SSID). Connect to it with up to eight computers or other devices. The Hotspot  icon appears in the Status bar.

To stop sharing the data connection, touch the toggle switch again.

## Data Usage

Data usage refers to the amount of data uploaded or downloaded by the device during a given period. Depending on the wireless plan, you may be charged additional fees when your data usage exceeds your plan's limit.

Data usage settings allow you to:

- Enable Data Saver.
- Set the data usage warning level.
- Set a data usage limit.
- View or restrict data usage by app.
- Identify mobile hotspots and restrict background downloads that may result in extra charges.

## Setting Data Limit

Set data limits to ensure that you do not go over your data plan limit.

1. Go to **Settings**.
2. Touch **Network & Internet > Mobile Network > Data warning & limit > Mobile data usage cycle**.
3. Touch **Set data limit**.

A message displays stating that the phone will turn off mobile data once it reaches the limit you set.

4. Touch **OK**.
5. Touch **Data limit**.
6. Enter a number.

To switch between megabytes (MB) and gigabytes (GB), touch the down arrow.

7. Touch **SET**.

## Setting Data Usage Warning

Set a warning alert when the device has used a certain amount of mobile data.

1. Go to **Settings**.

2. Touch **Network & Internet > Mobile Network > Data warning & limit > Mobile data usage cycle**.
  3. If necessary, touch **Set data warning** to enable it.
  4. Touch **Data warning**.
  5. Enter a number.  
To switch between megabytes (MB) and gigabytes (GB), touch the down arrow.
  6. Touch **SET**.
- When the data usage reaches the set level, a notification appears.

## Cellular Network Settings

Cellular network settings apply to MC3450 WWAN devices only.

### Data When Roaming

Roaming is disabled by default to prevent the device from transmitting data over other carriers' mobile networks when leaving an area that is covered by the carrier's networks. This is useful for controlling expenses if the service plan does not include data roaming.

### Enabling Data on GSM Devices

1. Go to **Settings**.
2. Touch **Networking & Internet > Mobile network**.
3. Touch **Roaming**.

The switch moves to the on position.

### Setting Preferred Network

Change the device network operating mode.

1. Go to **Settings**.
2. Touch **Network & Internet > Mobile network**.  
**Automatically select network** is enabled by default.
3. Touch **Network**.
4. In the **Available network** list, select a carrier network.

### Configuring the Access Point Name

To use the data on a network, configure the APN information.



**NOTE:** Many service provider Access Point Name (APN) data are pre-configured in the device. The APN information for all other service providers must be obtained from the wireless service provider.

1. Go to **Settings**.
2. Touch **Network & Internet > Mobile network > Access Point Names**.
3. Touch an APN name in the list to edit an existing APN or touch + to create a new APN.

4. Touch each APN setting and enter the appropriate data obtained from the wireless service provider.
5. When finished, touch  > **Save**.
6. Touch the radio button next to the APN name to start using it.

## Locking the SIM Card

Locking the SIM card requires you to enter a PIN every time the device is turned on. If the correct PIN is not entered, only emergency calls can be made.

1. Go to **Settings**.
2. Touch **Security > More security settings > SIM card lock > Lock SIM card**.
3. Enter the PIN associated with the card.
4. Touch **OK**.
5. Reset the device.

## Activating an eSIM

Use an eSIM on the MC3450. Before using it, activate the eSIM.



**NOTE:** Before adding an eSIM, contact your carrier to obtain the eSIM service and its activation or QR code.

1. On the device, establish an internet connection via Wi-Fi or cellular data with an installed SIM card.
2. Go to **Settings**.
3. Touch **Network & internet > Mobile Networks**.
4. Touch + next to **SIMs** if a SIM card is already installed, or touch **SIMs** if there is no SIM card installed. The **Mobile network** screen displays.
5. Select:
  - **MANUAL CODE ENTRY** to enter the activation code, or
  - **SCAN** to scan the QR code to download the eSIM profile.
 The **Confirmation!!!** dialog box displays.
6. Touch **OK**.
7. Enter the activation code or scan the QR Code.
8. Touch **NEXT**. The **Confirmation!!!** dialog box displays.
9. Touch **ACTIVATE**.
10. Touch **Done**. The eSIM is now active.

## Deactivating an eSIM

Turn off an eSIM temporarily and re-activate it later.

1. On the device, establish an internet connection via Wi-Fi or cellular data with an installed SIM card.

2. Touch **Network & internet > SIMs**.
3. In the **Downloaded SIM** section, touch the name of the eSIM to deactivate.
4. Touch **Use SIM** switch to turn off the eSIM.
5. Touch **Yes**.  
The eSIM is deactivated.

### Erasing an eSIM Profile

Erasing an eSIM profile removes it completely from the MC3450.



**NOTE:** After erasing an eSIM from the device, you cannot use it again.

1. On the device, establish an internet connection via Wi-Fi or cellular data with an installed SIM card.
2. Touch **Network & internet > SIMs**.
3. In the **Downloaded SIM** section, touch the name of the eSIM to erase.
4. Touch **Erase**.  
The **Erase this downloaded SIM?** message displays.
5. Touch **Erase**.  
The eSIM profile is erased from the device.

## Bluetooth

Bluetooth devices can communicate without wires, using frequency-hopping spread spectrum (FHSS) radio frequency (RF) to transmit and receive data in the 2.4 GHz Industry Scientific and Medical (ISM) band (802.15.1). Bluetooth wireless technology is specifically designed for short-range (10 m (32.8 ft)) communication and low power consumption.

Devices with Bluetooth capabilities can exchange information (for example, files, appointments, and tasks) with other Bluetooth enabled devices such as printers, access points, and other mobile devices.

The device supports Bluetooth Low Energy. Bluetooth Low Energy is targeted at applications in the healthcare, fitness, security, and home entertainment industries. It provides reduced power consumption and cost while maintaining standard Bluetooth range.

### Adaptive Frequency Hopping

Adaptive Frequency Hopping (AFH) is a method of avoiding fixed frequency interferers and also used with Bluetooth voice:

All devices in the piconet (Bluetooth network) must be AFH-capable in order for AFH to work. When connecting and discovering devices, AFH is not available. Avoid making Bluetooth connections and discoveries during critical 802.11b communications. AFH for Bluetooth consists of four main sections:

AFH for Bluetooth consists of four main sections:

- Channel Classification - A method of detecting an interference on a channel-by-channel basis, or pre-defined channel mask.
- Link Management - Coordinates and distributes the AFH information to the rest of the Bluetooth network.

- Hop Sequence Modification - Avoids interference by selectively reducing the number of hopping channels.
- Channel Maintenance - A method for periodically re-evaluating the channels.

The Bluetooth radio in this device operates as a Class 2 device power class. The maximum output power is 2.5 mW and the expected range is 10 m (32.8 ft). A definition of ranges based on power class is difficult to obtain due to power and device differences, whether in open space or closed office space.

## Security

The current Bluetooth specification defines security at the link level. Application-level security is not specified. This allows application developers to define security mechanisms tailored to their specific needs. Link-level security occurs between devices, not users, while application-level security can be implemented on a per-user basis. The Bluetooth specification defines security algorithms and procedures required to authenticate devices, and if needed, encrypt the data flowing on the link between the devices. Device authentication is a mandatory feature of Bluetooth while link encryption is optional.

Pairing of Bluetooth devices is accomplished by creating an initialization key used to authenticate the devices and create a link key for them. Entering a common personal identification number (PIN) in the devices being paired generates the initialization key. The PIN is never sent over the air. By default, the Bluetooth stack responds with no key when a key is requested (it is up to the user to respond to the key request event). Authentication of Bluetooth devices is based upon a challenge-response transaction. Bluetooth allows for a PIN or passkey used to create other 128-bit keys used for security and encryption. The encryption key is derived from the link key used to authenticate the pairing devices. Also, the limited range and fast frequency hopping of the Bluetooth radios make long-distance eavesdropping difficult.

Recommendations are:

- Perform pairing in a secure environment.
- Keep PIN codes private and do not store the PIN codes in the device.
- Implement application-level security.

## Bluetooth Profiles

The device supports the Bluetooth services listed.

**Table 20** Bluetooth Profiles

Profile	Description
Service Discovery Protocol (SDP)	Handles the search for known and specific services as well as general services.
Serial Port Profile (SPP)	Allows use of RFCOMM protocol to emulate serial cable connection between two Bluetooth peer devices. For example, connecting the device to a printer.
Object Push Profile (OPP)	Allows the device to push and pull objects to and from a push server.
Advanced Audio Distribution Profile (A2DP)	Allows the device to stream stereo-quality audio to a wireless headset or wireless stereo speakers.
Audio/Video Remote Control Profile (AVRCP)	Allows the device to control A/V equipment to which a user has access. It may be used in concert with A2DP.

**Table 20** Bluetooth Profiles (Continued)

Profile	Description
Personal Area Network (PAN)	Allows the use of Bluetooth Network Encapsulation Protocol to provide L3 networking capabilities over a Bluetooth link. Only PANU role is supported.
Human Interface Device Profile (HID)	Allows Bluetooth keyboards, pointing devices, gaming devices and remote monitoring devices to connect to the device.
Headset Profile (HSP)	Allows a hands-free device, such as a Bluetooth headset, to place and receive calls on the device.
Hands-Free Profile (HFP)	Allows car hands-free kits to communicate with the device in the car.
Phone Book Access Profile (PBAP)	Allows exchange of Phone Book Objects between a car kit and a mobile device to allow the car kit to display the name of the incoming caller; allow the car kit to download the phone book so you can initiate a call from the car display.
Out of Band (OOB)	Allows exchange of information used in the pairing process. Pairing is completed using the Bluetooth radio, but requires information from the OOB mechanism. Using OOB with NFC enables pairing when devices simply get close, rather than requiring a lengthy discovery process.
Symbol Serial Interface (SSI)	Allows for communication with Bluetooth Imager.
Generic Attribute Profile (GATT)	Provides profile discovery and description services for Bluetooth Low Energy protocol. It defines how attributes are grouped together into sets to form services.
Dial Up Networking (DUN)	Provides a standard to access the Internet and other dial-up services over Bluetooth.
OBject EXchange (OBEX)	Facilitates the exchange of binary objects between devices.

## Bluetooth Power States

The Bluetooth radio is off by default.

- **Suspend** - When the device goes into Sleep mode, the Bluetooth radio stays on.
- **Airplane Mode** - When the device is placed in Airplane Mode, the Bluetooth radio is not turned off when the device is connected to a Bluetooth headset or hearing device.

## Bluetooth Radio Power

Turn off the Bluetooth radio to save power or if entering an area with radio restrictions (for example, an airplane). When the radio is off, other Bluetooth devices cannot see or connect to the device. Turn on the Bluetooth radio to exchange information with other Bluetooth devices (within range). Communicate only with Bluetooth radios in close proximity.



**NOTE:** To achieve optimal battery life, turn off radios when not in use.

### Enabling Bluetooth

1. Swipe down from the Status bar to open the Notification panel.



2. Touch  to turn Bluetooth on.

### Disabling Bluetooth

1. Swipe down from the Status bar to open the Notification panel.
2. Touch  to turn Bluetooth off.

### Discovering Bluetooth Device(s)

The device can receive information from discovered devices without pairing. However, once paired, the device and a paired device exchange information automatically when the Bluetooth radio is on.

1. Ensure that Bluetooth is enabled on both devices.
2. Ensure that the Bluetooth device to discover is in discoverable mode.
3. Ensure that the two devices are within 10 m (32.8 ft) of one another.
4. Swipe down from the Status bar to open the Quick Access panel.
5. Touch and hold **Bluetooth**.
6. Touch **Pair new device**. The device begins searching for discoverable Bluetooth devices in the area and displays them under **Available devices**.
7. Scroll through the list and select a device. The Bluetooth pairing request dialog box appears.
8. Touch **Pair** on both devices.
9. The Bluetooth device is added to the **Paired devices** list and a trusted (“paired”) connection is established.

### Changing the Bluetooth Name

By default, the device has a generic Bluetooth name that is visible to other devices when connected.

1. Go to **Settings**.
2. Touch **Connected devices** > **Connection preferences** > **Bluetooth**.
3. If Bluetooth is not on, move the switch to turn Bluetooth on.
4. Touch **Device name**.
5. Enter a name and touch **RENAME**.

### Connecting to a Bluetooth Device

Once paired, connect to a Bluetooth device.

1. Go to **Settings**.
2. Touch **Connected devices** > **Connection preferences** > **Bluetooth**.
3. In the list, touch the unconnected Bluetooth device.

When connected, **Connected** appears below the device name.

## Selecting Profiles on the Bluetooth Device

Some Bluetooth devices have multiple profiles.

1. Go to **Settings**.
2. Touch **Connected devices** > **Connection preferences** > **Bluetooth**.
3. In the **Paired Devices** list, touch  next to the device name.
4. Turn on or off a profile to allow the device to use that profile.

## Unpairing a Bluetooth Device

Unpairing a Bluetooth device erases all pairing information.

1. Go to **Settings**.
2. Touch **Connected devices** > **Connection preferences** > **Bluetooth**.
3. In the **Paired Devices** list, touch  next to the device name.
4. Touch **FORGET**.

## Near Field Communications

NFC/HF RFID is a short-range wireless connectivity technology standard that enables secure transaction between a reader and a contactless smartcard. The technology is based on ISO/IEC 14443 type A and B (proximity) ISO/IEC 15693 (vicinity) standards, using the HF 13.56 MHz unlicensed band.

The MC3400/MC3450 supports the following operating modes:

- Reader mode
- Peer-to-Peer communication
- Card emulation mode

With NFC, the devices can:

- Read contactless cards such as contactless tickets, ID cards, payment cards, and ePassports.
- Read and write information to contactless cards (for example, SmartPosters and etickets), as well as devices with NFC interfaces (for example, vending machines).
- Read information from supported medical sensors.
- Pair with supported Bluetooth devices, such as printers, ring scanners, and headsets)
- Exchange data with another NFC device.

The NFC antenna is:

- Positioned to read NFC cards from the top of the device while the device is being held.
- Centrally aligned with the back housing directly underneath the regulatory label and designed for reading a range of NFC tags at distances from contact up to 2 cm from the rear of the device.

## Reading NFC Cards

Read contactless cards using NFC.

**Figure 26** Reading Cards

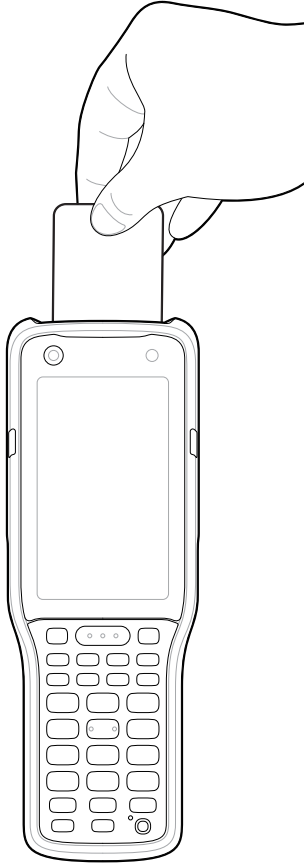

1. Launch an NFC-enabled application.
2. Hold the device as shown.
3. Move the device close to the NFC card until it detects the card.
4. Hold the card steadily until the transaction is complete (usually indicated by the application).

## Sharing Information Using NFC

By bringing the devices together (back to back), you can beam content, such as a web page, contact cards, pictures, video links, or location information, from your screen to another device.

Ensure that both devices:

- Are unlocked.
  - Support NFC.
  - Have Android Beam turned on.
1. Open a screen that contains a web page, video, photo, or contact.

2. Move the back of the device toward the back of the other device.
3. Align the NFC logo on the device with the NFC antenna on the other device.
4. Move the front of the device toward the front of the other device.

When the devices connect, a sound emits. The image on the screen reduces in size and **Touch to beam** displays.

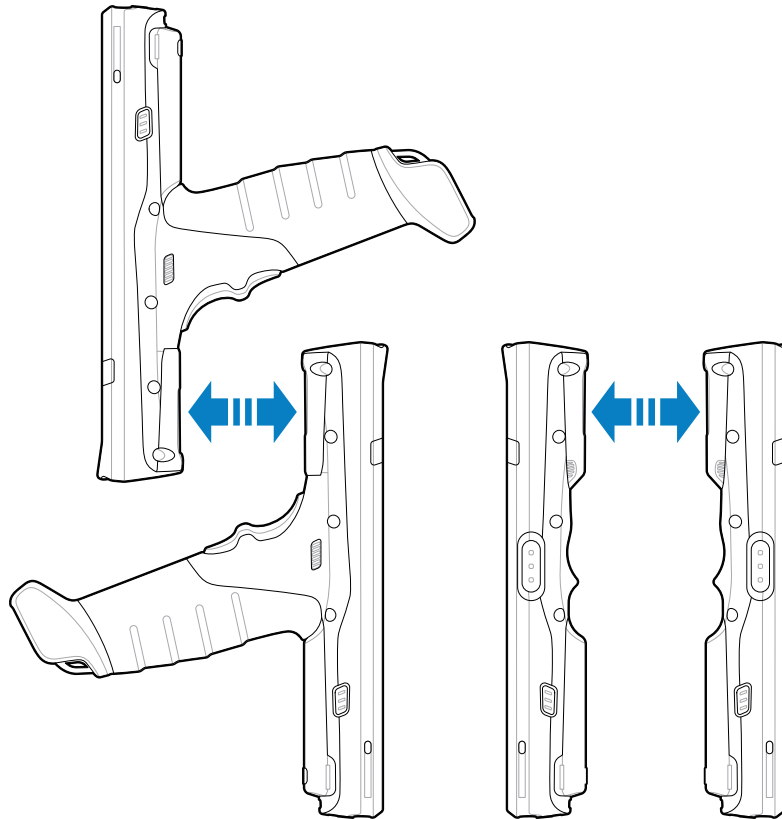

5. Touch anywhere on the screen.  
The transfer of information begins.

## Enterprise NFC Settings

Improve NFC performance or increase battery life by selecting which NFC features to use on the device.

To open Enterprise NFC Settings, go to **Settings > Connected devices > Connection Preference > NFC > Enterprise NFC Settings**.

- **Card Detection Mode** - Select a card detection mode.
  - **Low** - Increases battery life by lowering the NFC detection speed.
  - **Hybrid** - Provides a balance between NFC detection speed and battery life (default).
  - **Standard** - Provides the optimal NFC detection speed, but reduces battery life.

- **Supported Card Technology** - Select an option to detect only one NFC tag type, increasing battery life, but reducing detection speed.
  - **ISO 14443 Type A**
  - **ISO 14443 Type B**
  - **FeliCa**
  - **ISO 15693**
- **NFC Debug Logging** - Use to enable or disable debug logging for NFC.
- **Other NFC settings available with Zebra administrator tools (CSP)** - Allows configuration of additional Enterprise NFC Settings through staging tools and Mobile Device Management (MDM) solutions with an MX version that supports the Enterprise NFC Settings Configuration Service Provider (CSP). For more information on using the Enterprise NFC Settings CSP, refer to: [techdocs.zebra.com](https://techdocs.zebra.com).

## Cast

Use **Cast** to mirror the device screen on a Miracast enabled wireless display.

1. Go to **Settings**.
2. Touch **Connected devices > Connection preferences > Cast**.
3. Touch **⋮ > Enable wireless display**.  
The device searches for nearby Miracast devices and lists them.
4. Touch a device to begin casting.

# Accessories

This section provides information for using the accessories for the device. The following table lists the accessories available for the device.

Accessory	Part Number	Description
<b>Cradles</b>		
1-Slot USB Charge Cradle with Spare Battery Charger	CRD-MC33-2SUCHG-01	Charges the main battery and a spare battery, and synchronizes the MC34 with a host computer through a USB connection. Requires power supply (PWR-BGA12V50W0WW), DC line cord (CBL-DC-388A1-01), and a country-specific grounded AC line cord.
5-Slot Charge Only ShareCradle	CRD-MC33-5SCHG-01	Charge only. Charges up to five devices. Requires power supply (PWR-BGA12V108W0WW), DC line cord (CBL-DC-381A1-01), and a country-specific, grounded AC line cord.
5-Slot Ethernet ShareCradle	CRD-MC33-5SETH-01	Charges up to five devices and provides Ethernet communication for up to five devices. Requires power supply (PWR-BGA12V108W0WW), DC line cord (CBL-DC-381A1-01), and a country-specific, grounded AC line cord.
5-Slot Charge ShareCradle with 4-Slot Battery Charge	CRD-MC33-4SC4BC-01	Charge only. Charges up to four devices and up to four spare batteries. Requires power supply (PWR-BGA12V108W0WW), DC line cord (CBL-DC-381A1-01), and a country-specific, grounded AC line cord.
5-Slot Ethernet ShareCradle with 4-Slot Battery Charger	CRD-MC33-4SE4BC-01	Charges up to four devices and up to four spare batteries and provides Ethernet communication for up to four devices. Requires power supply (PWR-BGA12V108W0WW), DC line cord (CBL-DC-381A1-01), and a country-specific, grounded AC line cord.
<b>Chargers</b>		
4-Slot Spare Battery Charger	SAC-MC33-4SCHG-01	Charges up to four spare batteries. Requires power supply (PWR-BGA12V50W0WW), DC line cord (CBL-DC-388A1-01), and a country-specific, grounded AC line cord.

## Accessories

Accessory	Part Number	Description
20-Slot Spare Battery Charger	SAC-MC33-20SCHG-01	Charges up to 20 spare batteries. Requires power supply (PWR-BGA12V108W0WW), DC line cord (CBL-DC-381A1-01), and a country-specific, grounded AC line cord.
Power Supply	PWR-BGA12V50W0WW	Level VI power supply. Provides 12 VDC, 2.5A power to the 1-Slot USB Charge Cradle and the 4-Slot Spare Battery Charger. Requires a DC line cord (CBL-DC-388A1-01) and a country specific grounded AC line cord.
Power Supply	PWR-BGA12V108W0WW	Level VI power supply. Provides 12 VDC, 2.5A power to the 5-Slot Charge Only Cradle, 5-Slot Ethernet Cradle, 5-Slot Charge Cradle with 4-Slot Battery Charger, 5-Slot Ethernet Cradle with 4-Slot Battery Charger and 20-Slot Battery Charger. Requires a DC line cord (CBL-DC-381A1-01) and a country specific grounded AC line cord.
Power Supply	PWR-WUA5V12W0US	Wall adapter; Provides 5 VDC, 2.5A power to the USB Charge Cable. Includes plug adapter for use in the United States.
Power Supply	PWR-WUA5V12W0GB	Provides 5 VDC, 2.5A power to the USB Charge Cable. Includes plug adapter for use in the European Union.
Power Supply	PWR-WUA5V12W0EU	Provides 5 VDC, 2.5A power to the USB Charge Cable. Includes plug adapter for use in the United Kingdom.
Power Supply	PWR-WUA5V12W0AU	Provides 5 VDC, 2.5A power to the USB Charge Cable. Includes plug adapter for use in Australia.
Power Supply	PWR-WUA5V12W0CN	Provides 5 VDC, 2.5A power to the USB Charge Cable. Includes plug adapter for use in China.
Power Supply	PWR-WUA5V12W0IN	Provides 5 VDC, 2.5A power to the USB Charge Cable. Includes plug adapter for use in India.
Power Supply	PWR-WUA5V12W0BR	Provides 5 VDC, 2.5A power to the USB Charge Cable. Includes plug adapter for use in Brazil.
US AC Line Cord	23844-00-00R	Provides power to 3-wire power supplies PWR-BGA12V50W0WW and PWR-BGA12V108W0WW.
DC Line Cord	CBL-DC-381A1-01	Provides power from the power supply (PWR-BGA12V108W0WW) to the 5-Slot Charge Only Cradle, 5-Slot Ethernet Cradle, 5-Slot Charge Cradle with 4-Slot Battery Charger, 5-Slot Ethernet Cradle with 4-Slot Battery Charger and 20-Slot Battery Charger.
DC Line Cord	CBL-DC-388A1-01	Provides power from the power supply (PWR-BGA12V150W0WW) to the 1-Slot USB Charge Cradle and 4-Slot Battery Charger.

## Accessories

Accessory	Part Number	Description
<b>Cables</b>		
USB Charge Cable	CBL-MC33-USBCHG-01	Provides power and/or communication over USB to the device. Requires wall adapter/power supply PWR-WUA5V12W0xx.
1-Slot Cradle USB Cable	25-124330-01R	Provides USB communication through the 1-Slot USB cradle to the host computer.
<b>Miscellaneous</b>		
Cradle Adapter	ADP-MC33-CRDCUP-01	Charge Only Adapter for backwards compatibility with MC32 cradles. Works with MC32N0 1-Slot USB Cradle, 4-Slot Charge Only Cradle, and 4-Slot Ethernet Cradles.
7,000 mAh Battery (Extended PowerPrecision+)	BTRY-MC3X-70MA-01 BTRY-MC3X-70MA-IN	Replacement extended capacity battery. Replacement extended capacity battery (India).
7,000 mAh Rechargeable Li-Ion Battery with BLE Beacon	BTRY-MC3X-7BLE-01 BTRY-MC3X-7BLE-IN	Replacement battery with BLE beacon. Replacement battery with BLE beacon (India).
Hand Strap for Gun	SG-MC33-HDSTPG-01	Hand strap for the Gun configuration. Hand strap loop holds an optional stylus (SG-TC7X-STYLUS-03).
Hand Strap for Straight Shooter	SG-MC34-HDSTPB-01	Hand strap for the Straight Shooter configuration.
Rigid Holster	SG-MC34-RDHLST-01	Provides a clip-on holder for Straight Shooter configuration.
Fabric Holster for Gun	SG-MC3021212-01R	Provides a soft, clip-on holster and a shoulder strap for the Gun configuration.
Fabric Holster for Straight Shooter	SG-MC3X-SHLSTB-01	Provides a soft, clip-on holder and a shoulder strap for the Straight Shooter configuration.
Shoulder Strap	58-40000-007R	Shoulder strap.
Belt	11-08062-02R	Belt for fabric holster.
Rubber Boot for Gun	SG-MC34-RBTG-01	Provides additional protection for the Gun configuration.
Rubber Boot for Straight Shooter	SG-MC34-RBTS-01	Provides additional protection for the Straight Shooter configuration.
Tempered Glass Screen Protector	MISC-MC34-SCRN-01	Provides additional protection for display (5-pack).
Stylus and Tether	SG-TC7X-STYLUS-03	Conductive carbon-filled stylus for capacitive touch panel; includes coiled tether (3-pack).



Accessory	Part Number	Description
Un-powered Forklift Mount	MNT-MC33-FLCHKT-01	Un-powered forklift mount. Allows installing the device on a roll bar or square surface of a forklift. Includes: Forklift holder (MNT-MC33-FLCH-01), RAM double socket arm for 1" ball (MNT-RAM-B201U) and RAM forklift clamp 2.5" max width square rail base with 1" ball (MNT-RAM-B247U25).

## Battery Compatibility

The MC3400 and MC3450 use rechargeable Lithium-ion (Li-ion) batteries as their main power source.

MC34 devices are compatible with:

- MC34 7,000 mAh PowerPrecision+ extended-capacity Li-ion battery (Battery P/N: BT-000375-0810/0A10)
- MC34 7,000 mAh PowerPrecision+ extended-capacity Li-ion battery with BLE beacon (Battery P/N: BT-000375-081B/0A1B)



**NOTE:** MC34 batteries are also compatible with MC3300 and MC3300ax.

MC34 devices are also compatible with MC33 legacy batteries but with reduced ingress protection (IP) sealing:

- MC33 7,000 mAh PowerPrecision+ extended-capacity Li-ion battery (Battery P/N: BT-000375-10/12/60)
- MC33 7,000 mAh PowerPrecision+ extended capacity Li-ion battery with BLE Beacon (Battery P/N: BT-000444-10/12/60)
- MC33 5,200 mAh PowerPrecision+ high-capacity Li-ion battery (Battery P/N: BT-000337-00/01/02)

## Accessories for Charging

Use one of the following accessories to charge the device and/or spare battery.

### Charging and Communication

Description	Part Number	Charging		Communication	
		Battery (In device)	Spare Battery	USB	Ethernet
1-Slot USB Charge Cradle with Spare Battery Charger	CRD-MC33-2SUCHG-01	Yes	Yes	Yes	No
5-Slot Charge Only ShareCradle	CRD-MC33-5SCHG-01	Yes	No	No	No
5-Slot Ethernet ShareCradle	CRD-MC33-5SETH-01	Yes	No	No	Yes
5-Slot Charge ShareCradle with 4-Slot Battery Charger	CRD-MC33-4SC4BC-01	Yes	Yes	No	No
5-Slot Ethernet ShareCradle with 4-Slot Battery Charger	CRD-MC33-4SE4BC-01	Yes	Yes	No	Yes
4-Slot Spare Battery Charger	SAC-MC33-4SCHG-01	No	Yes	No	No

Description	Part Number	Charging		Communication	
		Battery (In device)	Spare Battery	USB	Ethernet
20-Slot Spare Battery Charger	SAC-MC33-20SCHG-01	No	Yes	No	No
USB Charge Cable	CBL-MC33-USBCHG-01	Yes	No	Yes	No
MC32N0 1-Slot Cradle with Cradle Adapter	CRD3000-1001RR ADP-MC33-CRDCUP-01	Yes	Yes	Yes	No



**NOTE:** The recommended charging method for the MC34 devices is using a charging cradle, as it is faster than other charging options

## 1-Slot USB Charge Cradle with Spare Battery Charger

The 1-Slot USB Charge Cradle simultaneously charges the main and spare battery.



**CAUTION:** Ensure that you follow the guidelines for battery safety described in the [Battery Safety Guidelines](#).

The 1-Slot USB Charge Cradle:

- Provides 9 VDC power for charging the mobile computer and the battery.
- Provides 4.2 VDC power to charge the spare battery.
- Provides a USB port for data communication between the mobile computer and a host computer or other USB devices (for example, a laptop or printer).
- Synchronizes information between the mobile computer and a host computer. With customized or third-party software, it can also synchronize the mobile computer with corporate databases.
- Compatible with the following batteries:
  - 7,000 mAh PowerPrecision+ battery with a BLE beacon
  - 7,000 mAh PowerPrecision+ battery
  - 5,200 mAh PowerPrecision+ battery

**Figure 27** 1-Slot USB Charge Cradle with Spare Battery Charger

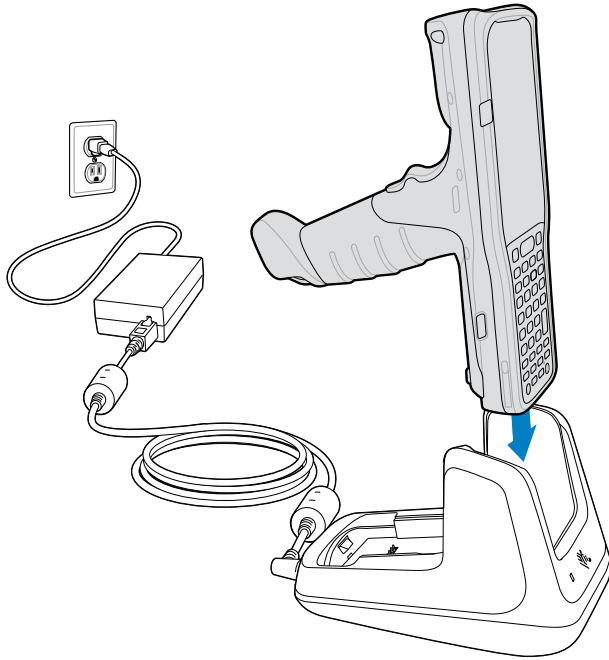

**Figure 28** Spare Battery Charging

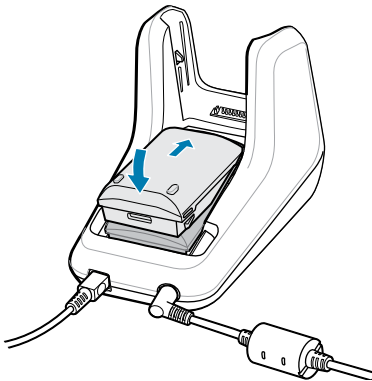

## Setup

Setting up the 1-Slot USB Charge Cradle with Spare Battery.

**Figure 29** 1-Slot USB Charge Cradle with Spare Battery Charge Setup

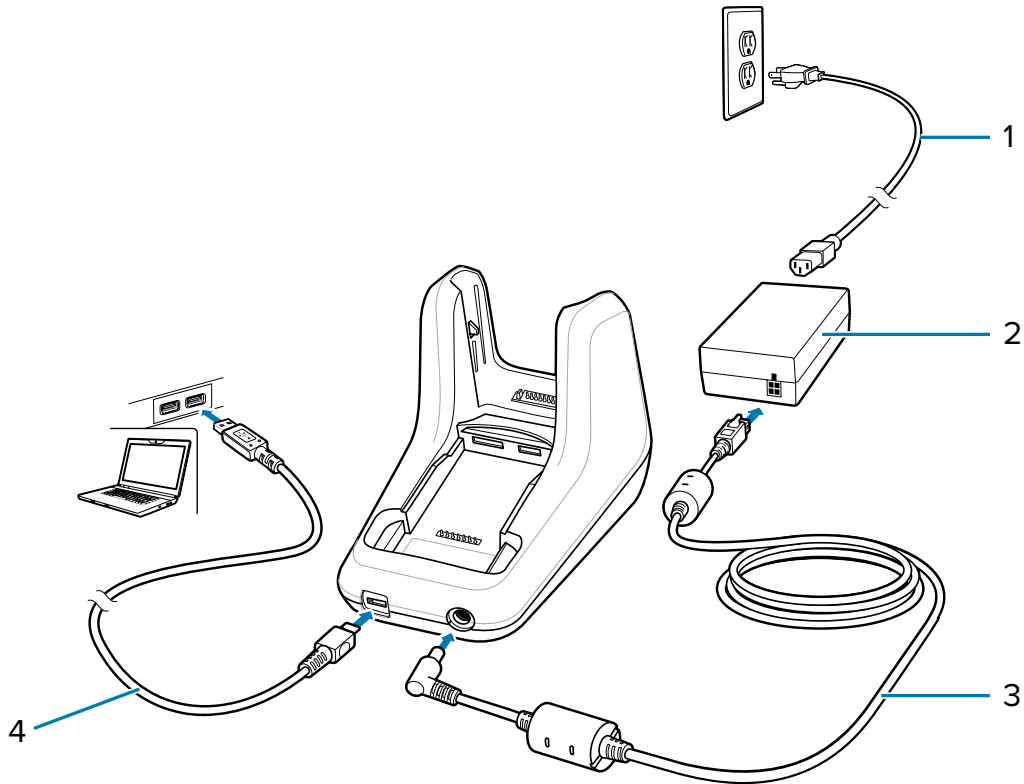

1	AC line cord
2	Power supply
3	DC line cord
4	USB cable

## Charging a Spare Battery

1. Ensure that the cradle is connected to power.

2. Insert the spare battery into the cradle, bottom first, and pivot the top of the battery down onto the contact pins.

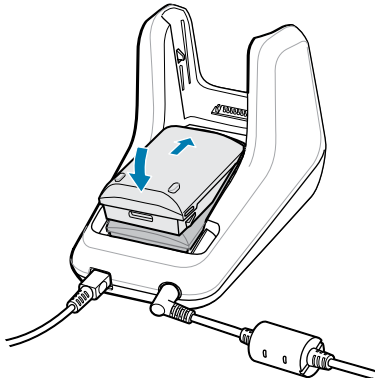

3. Gently press down on the battery to ensure proper contact.  
The Spare Battery Charging LED on the front of the cradle indicates the spare battery charging status.
4. When charging is complete, lift the battery out of the slot.

## 5-Slot Charge Only ShareCradle

The 5-Slot Charge Only ShareCradle simultaneously charges up to five devices.



**CAUTION:** Ensure that you follow the guidelines for battery safety described in the [Battery Safety Guidelines](#).

The 5-Slot Charge Only Cradle provides 9 VDC power for charging the mobile computer and battery.

**Figure 30** 5-Slot Charge Only ShareCradle

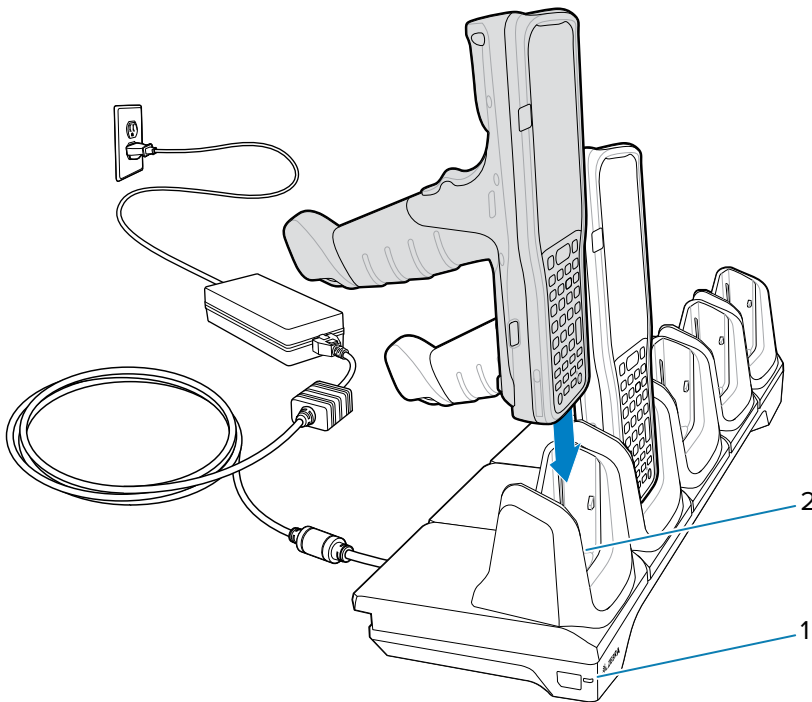

1	Power LED
2	Charging Slot

**Setup**

Setting up the 5-Slot Charge Only ShareCradle.

**Figure 31** 5-Slot Charge Only ShareCradle Setup

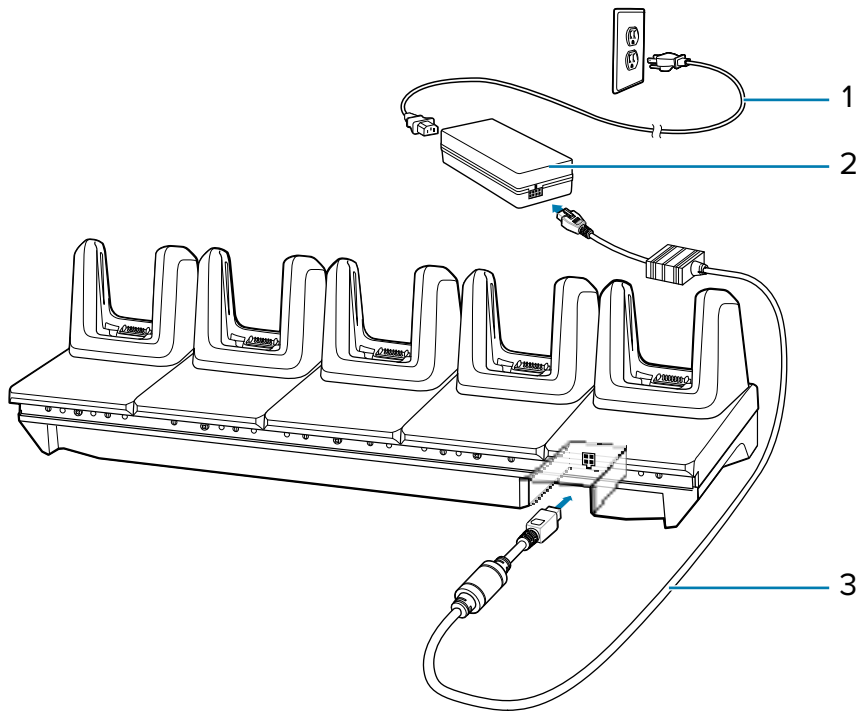

1	AC line cord
2	Power supply
3	DC line cord

**5-Slot Ethernet ShareCradle**

The 5-Slot Ethernet ShareCradle simultaneously charges up to five devices and provides Ethernet communication.



**CAUTION:** Ensure that you follow the guidelines for battery safety described in the [Battery Safety Guidelines](#).

The 5-Slot Ethernet ShareCradle provides 9 VDC power for charging the mobile computer and battery.

**Figure 32** 5-Slot Ethernet ShareCradle

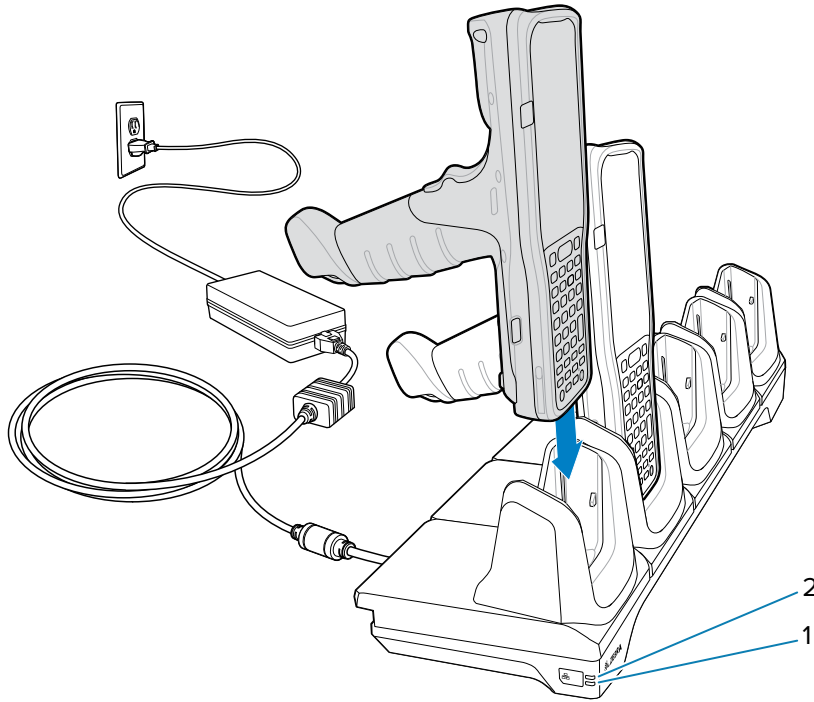

1	1000 LED
2	10/100 LED

## Setup

Setting up the 5-Slot Ethernet ShareCradle.

**Figure 33** 5-Slot Ethernet ShareCradle Setup

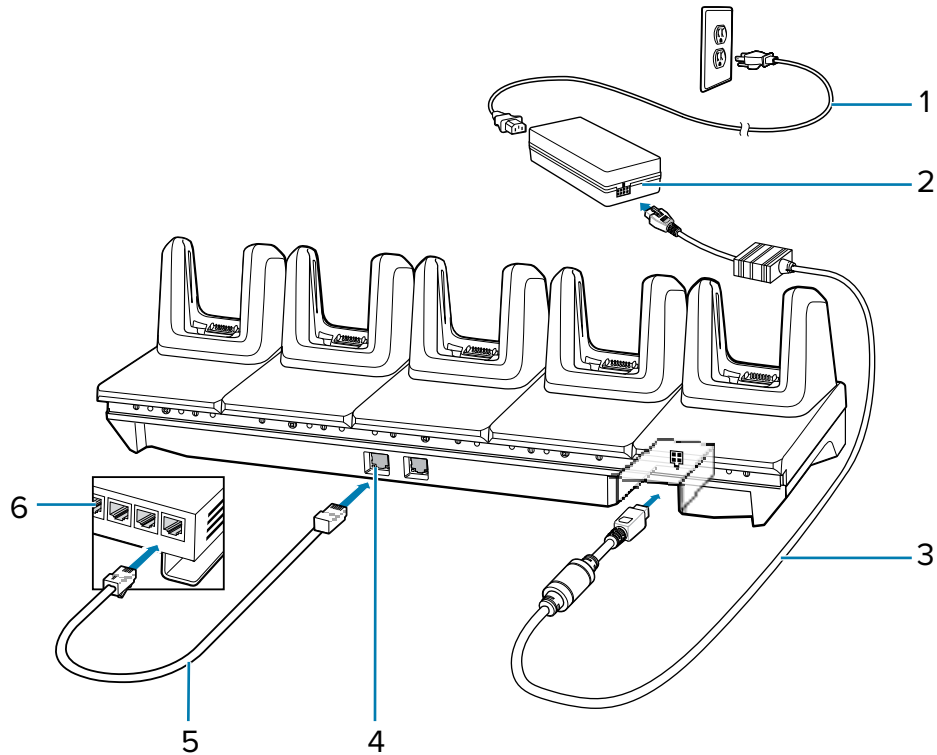

1	AC line cord
2	Power supply
3	DC line cord
4	Primary Port
5	Ethernet Cable
6	Router

## Daisy-Chaining Ethernet ShareCradles

Daisy-chain up to ten 5-Slot Ethernet ShareCradles to connect several cradles to an Ethernet network. Use either a straight or crossover cable.

Do not daisy-chain when the main Ethernet connection to the first cradle is 10 Mbps as throughput issues will almost certainly result.

1. Connect power (3) to each 5-Slot Ethernet ShareCradle.
2. Connect an Ethernet cable to one of the ports on the switch (5) and the other end to the Primary Port (1) of the first cradle.
3. Connect an Ethernet cable to the Secondary Port (2) of the first cradle.



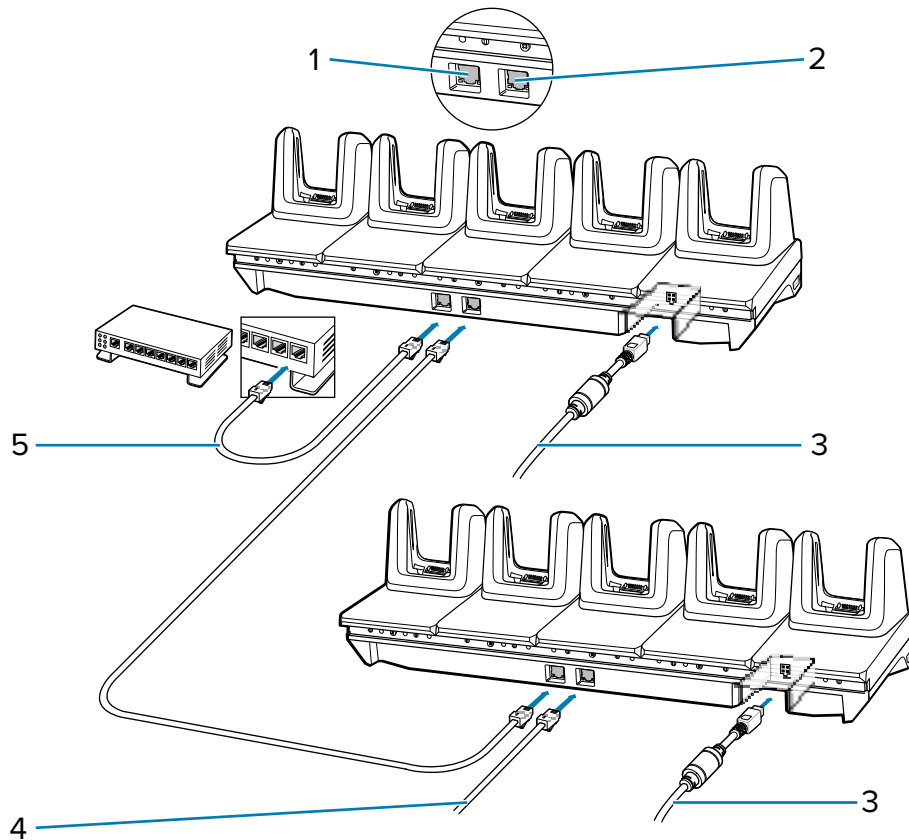

4. Connect the other end of the Ethernet cable (4) to the Primary Port of the next 5-Slot Ethernet ShareCradle.



5. Connect additional cradles as described in step 3 and 4.

### Establishing Ethernet Connection

1. Swipe down from the status bar to open the quick access panel and then touch .
2. Touch **Ethernet**
3. Slide the Ethernet switch to the **ON** position.
4. Insert the device into a slot.

The  icon appears in the Status bar.

5. Touch **Eth0** to view Ethernet connection details.

## LED Indicators

There are two green LEDs on the side of the cradle. These green LEDs light and blink to indicate the data transfer rate.

**Table 21** LED Data Rate Indicators

Data Rate	1000 LED	100/10 LED
1 Gbps	On/Blink	Off
100 Gbps	Off	On/Blink
10 Gbps	Off	On/Blink

## 5-Slot ShareCradle with 4-Slot Battery Charger

The 5-Slot ShareCradle with 4-Slot Battery Charger charges up to four devices and up to four spare batteries on the same cradle.



**CAUTION:** Ensure that you follow the guidelines for battery safety described in the [Battery Safety Guidelines](#).

The 5-Slot ShareCradle with 4-Slot Battery Charger:

- Provides 9 VDC power for charging the mobile computer and the battery.
- Provides 4.2 VDC power to charge the spare battery.
- Compatible with the following batteries:
  - 7,000 mAh PowerPrecision+ battery with a BLE beacon
  - 7,000 mAh PowerPrecision+ battery
  - 5,200 mAh PowerPrecision+ battery

**Figure 34** 5-Slot Charge ShareCradle with 4-Slots for Batteries

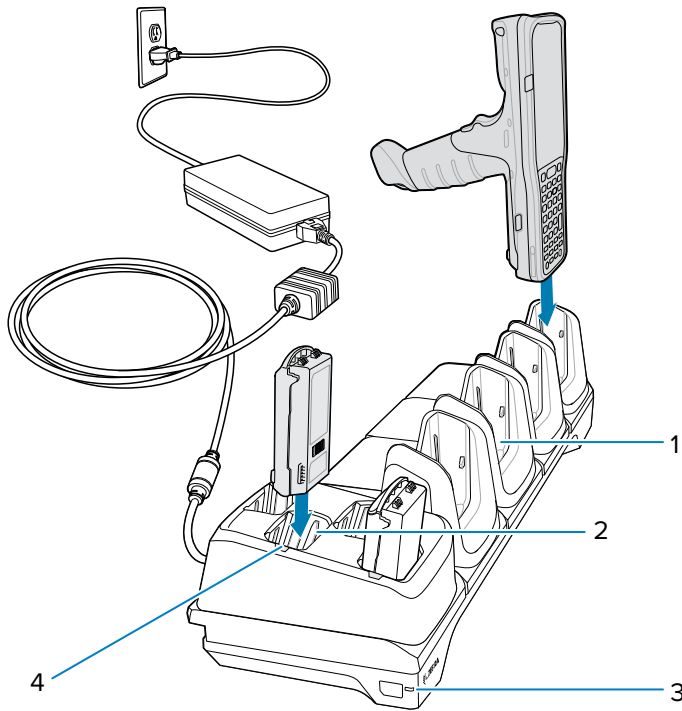

1	Charging slot
2	Spare battery slot
3	Power LED
4	Spare battery charging LED

## Setup

Setting up the 5-Slot ShareCradle with 4-Slot Battery Charger.

**Figure 35** 5-Slot ShareCradle with 4-Slot Battery Charger Setup

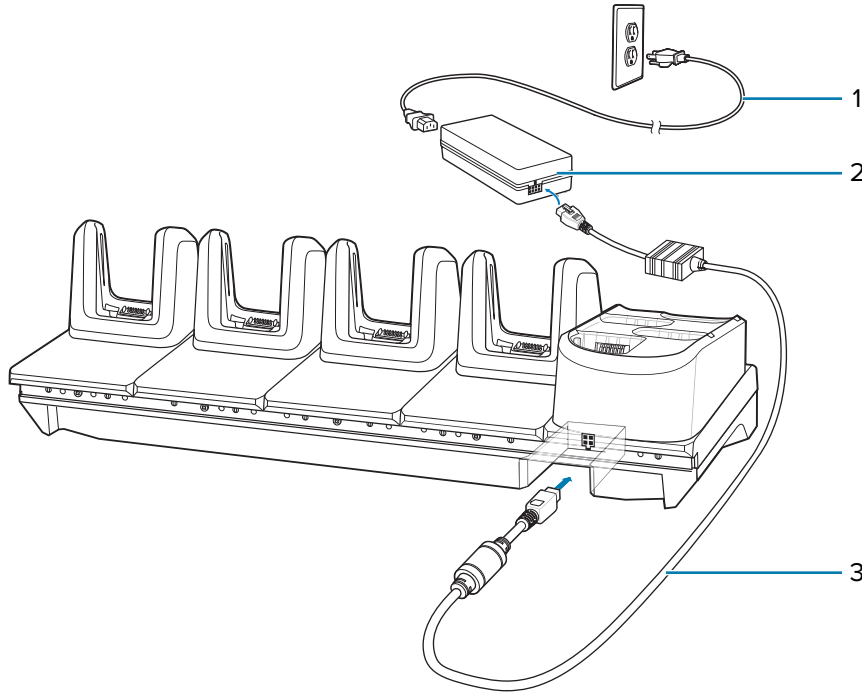

1	AC line cord
2	Power supply
3	DC line cord

## 5-Slot Ethernet ShareCradle with 4-Slot Battery Charger

The 5-Slot Ethernet ShareCradle with 4-Slot Battery Charger charges up to four devices and up to four spare batteries on the same cradle and provides Ethernet communication.



**CAUTION:** Ensure that you follow the guidelines for battery safety described in the [Battery Safety Guidelines](#).

The 5-Slot Ethernet ShareCradle with 4-Slot Battery Charger:

- Provides 9 VDC power for charging the mobile computer and charging the battery.
- Provides 4.2 VDC power to charge the spare battery.
- Compatible with the following batteries:
  - 7,000 mAh PowerPrecision+ battery with a BLE beacon
  - 7,000 mAh PowerPrecision+ battery
  - 5,200 mAh PowerPrecision+ battery

**Figure 36** 5-Slot Ethernet ShareCradle with 4-Slots for Batteries

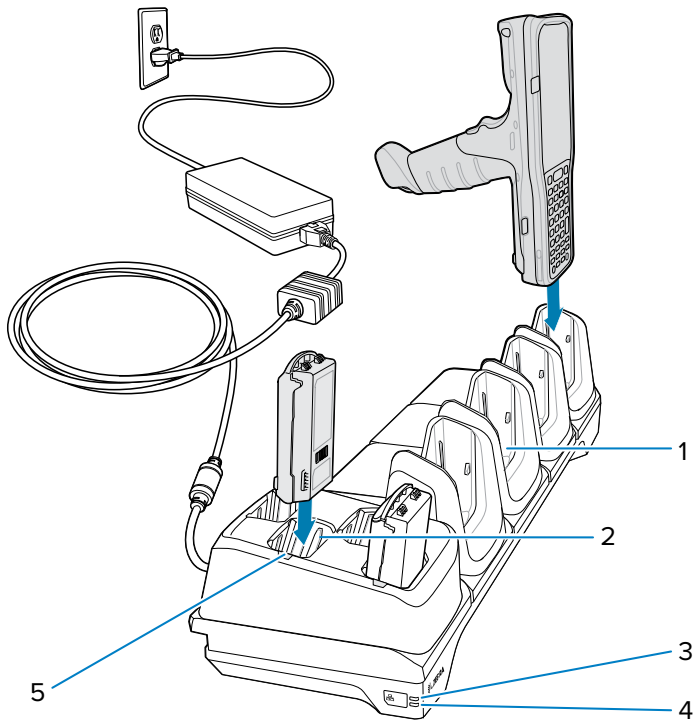

1	Charging slot
2	Spare battery slot
3	1000 LED
4	10/100 LED
5	Spare battery charging LED

## Setup

Setting up the 5-Slot Ethernet ShareCradle with 4-Slot Battery Charger.

**Figure 37** 5-Slot Ethernet ShareCradle with 4-Slot Battery Charger Setup

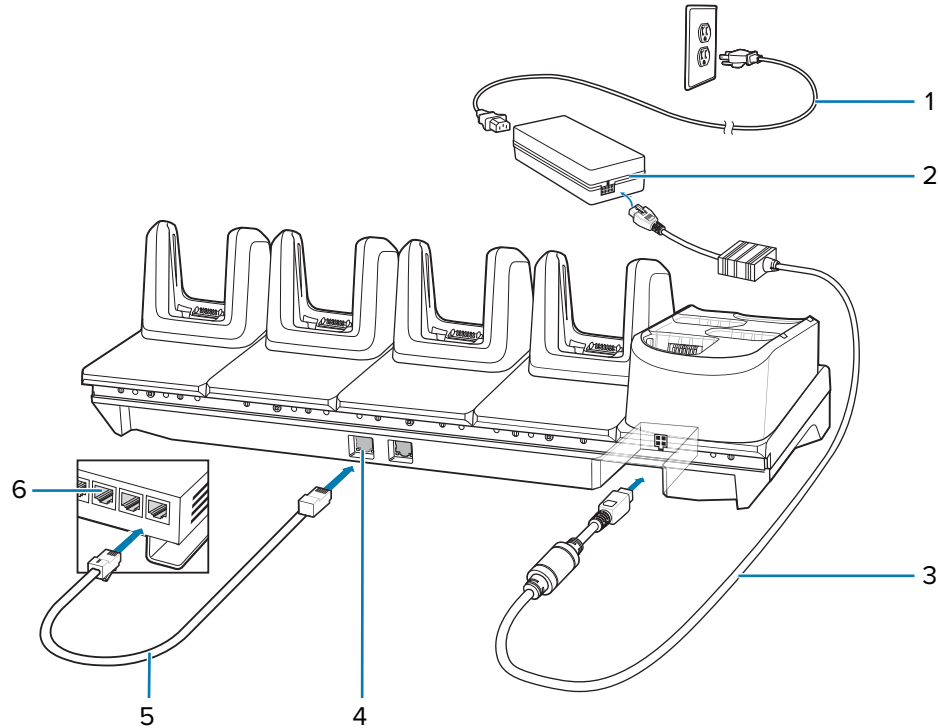

1	AC line cord
2	Power supply
3	DC line cord
4	Primary Port
5	Ethernet Cable
6	Router

## Daisy-Chaining Ethernet ShareCradles

Daisy-chain up to ten 5-Slot Ethernet ShareCradles to connect several cradles to an Ethernet network. Use either a straight or crossover cable.

Do not daisy-chain when the main Ethernet connection to the first cradle is 10 Mbps as throughput issues will almost certainly result.

1. Connect power (3) to each 5-Slot Ethernet ShareCradle.
2. Connect an Ethernet cable to one of the ports on the switch (5) and the other end to the Primary Port (1) of the first cradle.
3. Connect an Ethernet cable to the Secondary Port (2) of the first cradle.

4. Connect the other end of the Ethernet cable (4) to the Primary Port of the next 5-Slot Ethernet ShareCradle.

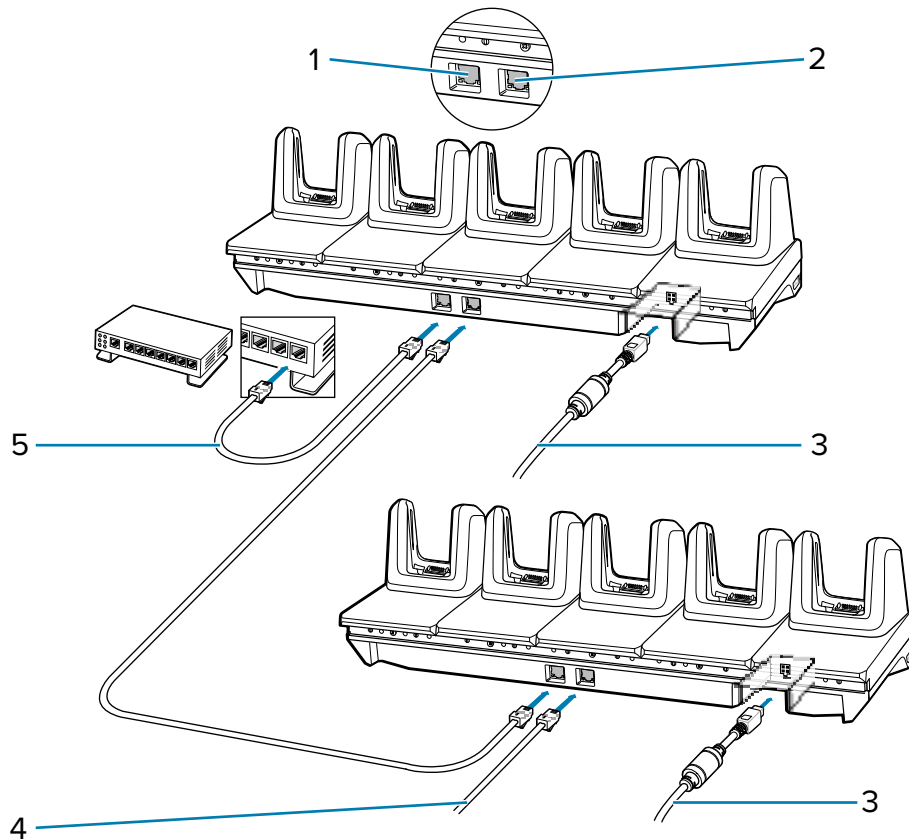

5. Connect additional cradles as described in step 3 and 4.

### Establishing Ethernet Connection

1. Swipe down from the status bar to open the quick access panel and then touch .
2. Touch **Ethernet**
3. Slide the Ethernet switch to the **ON** position.
4. Insert the device into a slot.

The  icon appears in the Status bar.

5. Touch **Eth0** to view Ethernet connection details.

### LED Indicators

There are two green LEDs on the side of the cradle. These green LEDs light and blink to indicate the data transfer rate.

**Table 22** LED Data Rate Indicators

Data Rate	1000 LED	100/10 LED
1 Gbps	On/Blink	Off
100 Gbps	Off	On/Blink
10 Gbps	Off	On/Blink

### 4-Slot Spare Battery Charger

The 4-Slot Spare Battery Charger simultaneously charges up to four batteries.



**CAUTION:** Ensure that you follow the guidelines for battery safety described in the [Battery Safety Guidelines](#).

The 4-Slot Spare Battery Charger:

- Provides 4.2 VDC power to charge the spare battery.
- Compatible with the following batteries:
  - 7,000 mAh PowerPrecision+ battery with a BLE beacon
  - 7,000 mAh PowerPrecision+ battery
  - 5,200 mAh PowerPrecision+ battery

**Figure 38** 4-Slot Spare Battery Charger

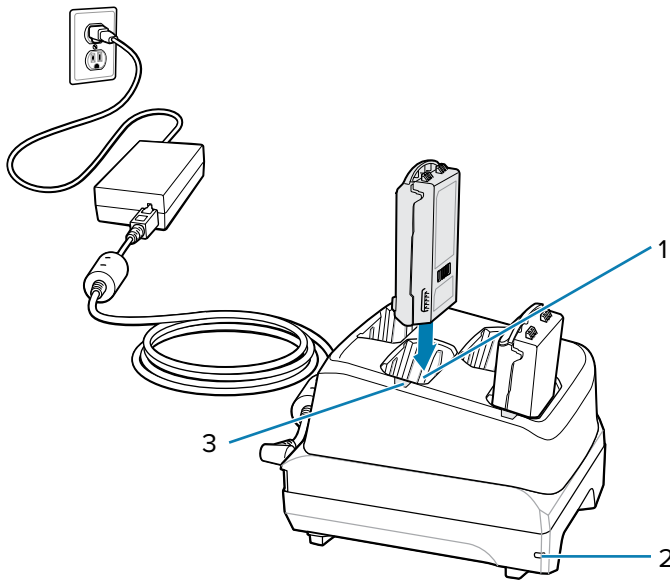

1	Spare battery charging slot
---	-----------------------------



2	Power LED
3	Spare battery charging LED

**Setup**

Setting up the 4-Slot Spare Battery Charger.

**Figure 39** 4-Slot Battery Charger Setup

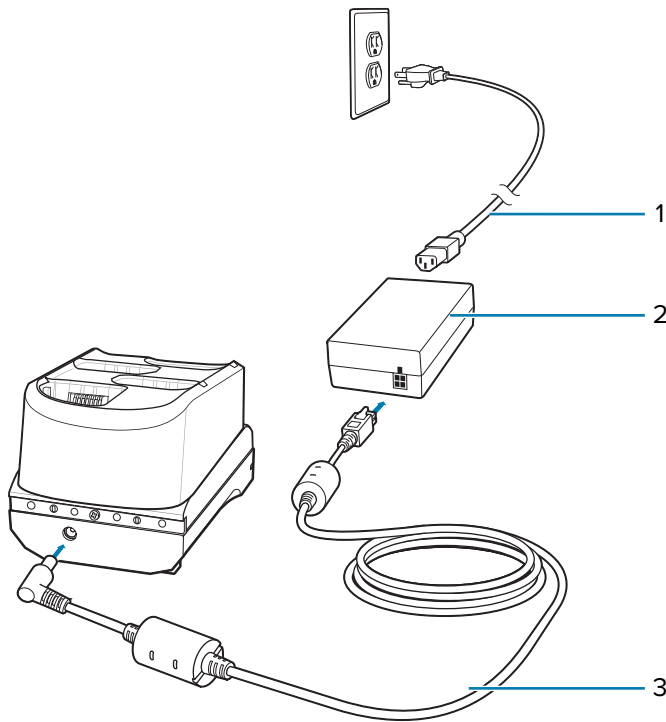

1	AC line cord
2	Power supply
3	DC line cord

**Charging Spare Batteries**

1. Connect the charger to a power source.

2. Insert the battery into the charger and gently press down on the battery to ensure proper contact.

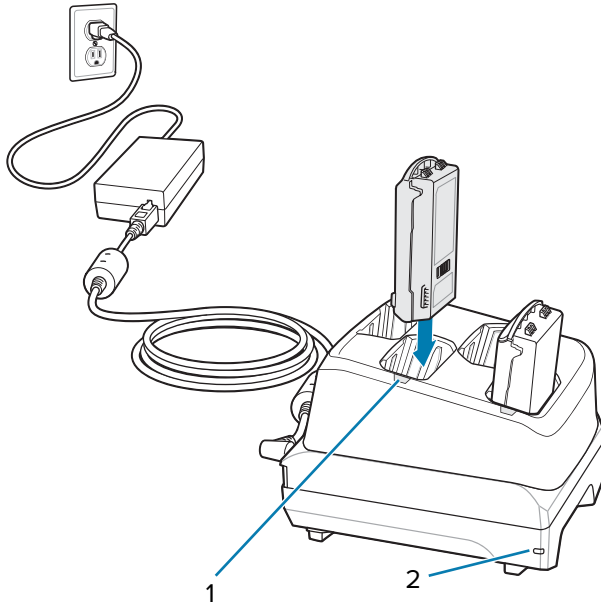

1	Spare battery charging LED
2	Power LED

## 20-Slot Spare Battery Charger

The 20-Slot Spare Battery Charger simultaneously charges up to 20 spare batteries.



**CAUTION:** Ensure that you follow the guidelines for battery safety described in the [Battery Safety Guidelines](#).

The 4-Slot Spare Battery Charger:

- Provides 4.2 VDC power to charge the spare battery.
- Compatible with the following batteries:
  - 7,000 mAh PowerPrecision+ battery with a BLE beacon
  - 7,000 mAh PowerPrecision+ battery
  - 5,200 mAh PowerPrecision+ battery

**Figure 40** 20-Slot Spare Battery Charger

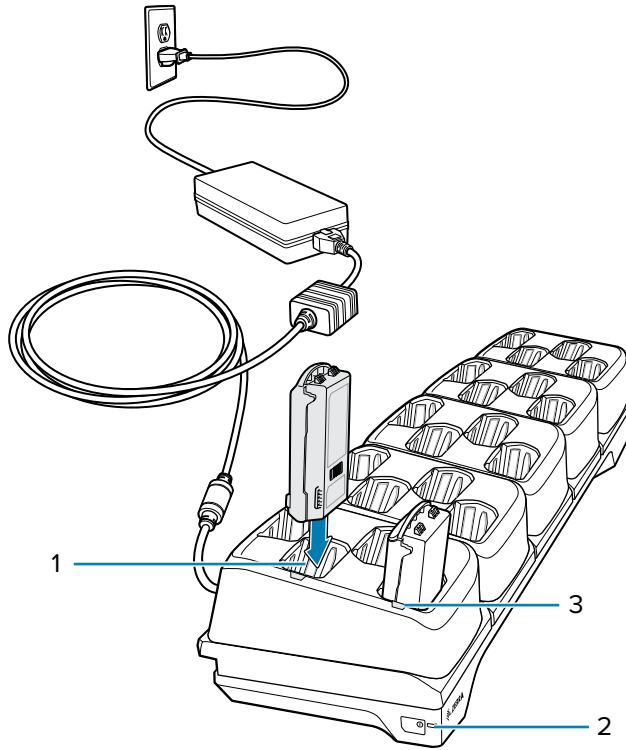

1	Spare battery charging slot
2	Power LED
3	Spare battery charging LED

## Setup

Setting up the 20-Slot Spare Battery Charger.

**Figure 41** 20-Slot Battery Charger Setup

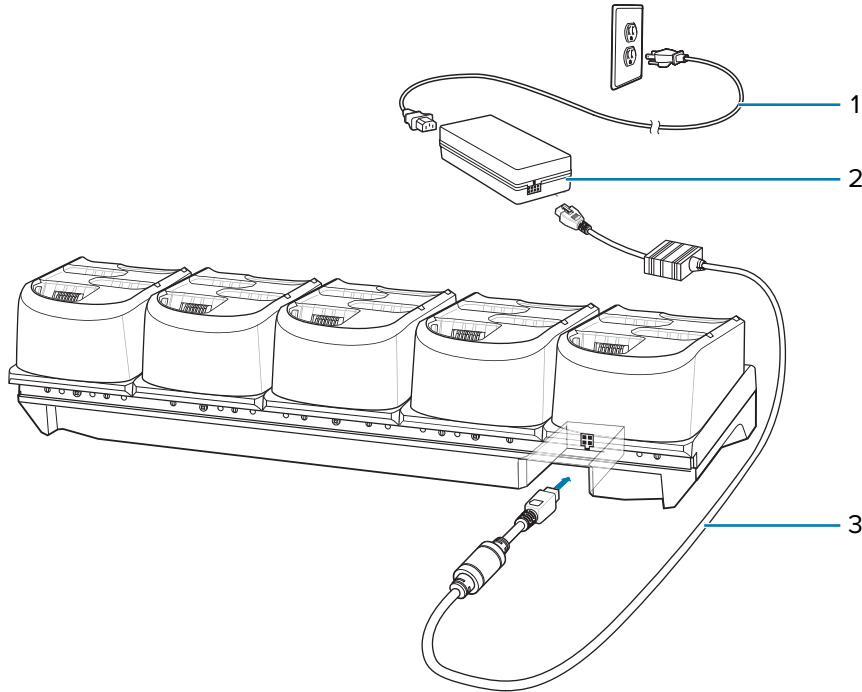

1	AC line cord
2	Power supply
3	DC line cord

## Charging Spare Batteries

1. Connect the charger to a power source.

2. Insert the battery into the charger and gently press down on the battery to ensure proper contact.

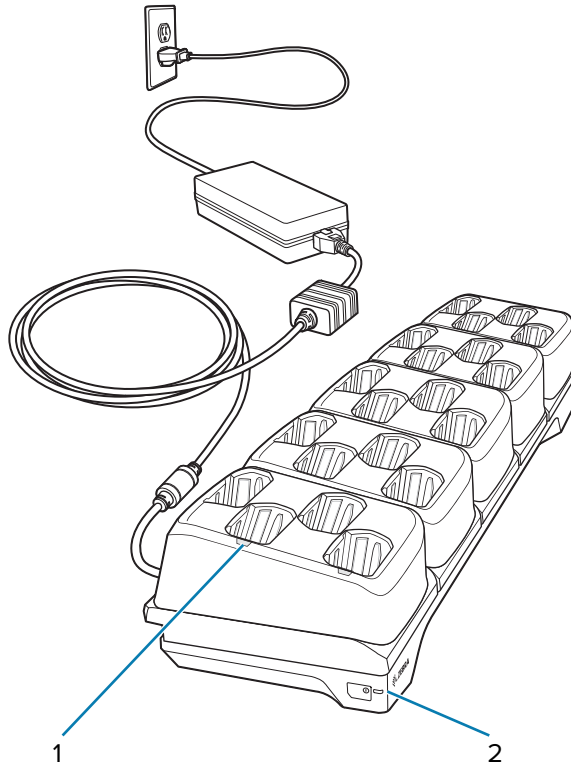

1	Spare battery charging LED
2	Power LED

## USB Connection

There are two methods for USB connection: The USB cradle via the bottom connector and the USB-C port on the side of the device.

- The device is designed for only one USB connection at any given time, either using the bottom USB connector via a charging/communication cradle or the side USB-C connector.
- Simultaneous connections via both bottom and side USB connections are not supported.
- If you attempt to connect via both the bottom and side USB-C at the same time, the bottom USB host will establish the connection, and the side USB-C will not.
- However, if the device is in a charge-only cradle via the bottom connector, the USB-C is still available for connection.

## USB Charging Cable

The USB Cradle provides charging when using a PowerPrecision+ battery and a wall adapter. It also allows USB communication to the device when connected to a laptop/PC.



**CAUTION:** Ensure that you follow the guidelines for battery safety described in the [Battery Safety Guidelines](#).

The USB Charge Cable:

- Provides 5 VDC power to charge the spare battery.
- Provides power and/or communication with the host computer over USB to the device.
- Compatible with the following batteries:
  - 7,000 mAh PowerPrecision+ extended capacity battery with a BLE beacon
  - 7,000 mAh PowerPrecision+ extended capacity battery
  - 5,200 mAh PowerPrecision+ high-capacity battery

**Figure 42** USB Charge Cable Connecting to Device

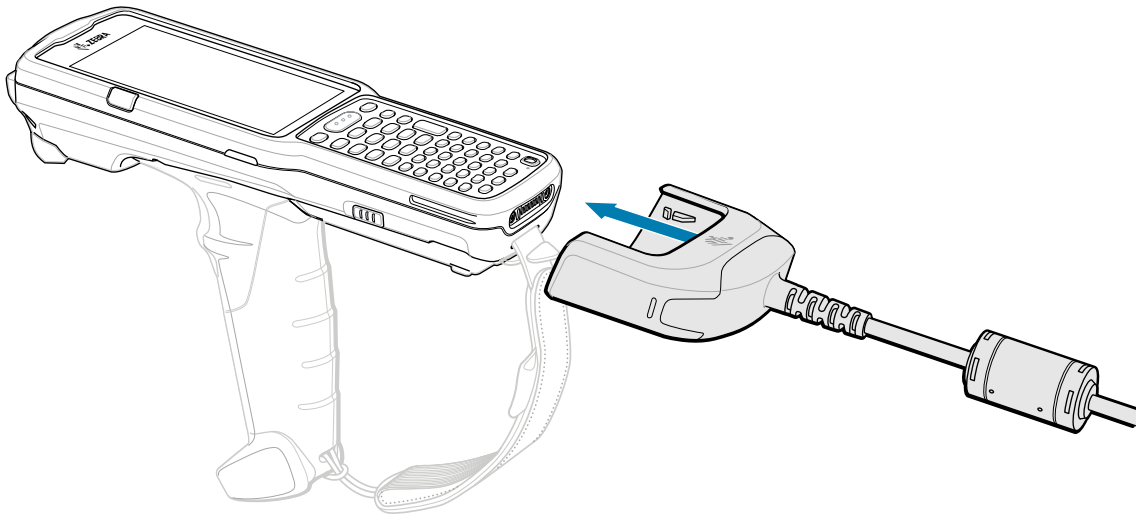

### USB-C Cable

The USB-C Cable connects to the left side of the device, provides communication with the host computer, and is removed easily when not in use.



**NOTE:** The recommended charging method for the MC34 devices is using a charging cradle, as it is faster than other charging options. If you charge the device using the USB-C cable, ensure the bottom connector is not connected to any charging accessories.



**WARNING:** If the device is charging and moisture is detected in the USB-C port, a warning message displays on the screen, and charging will be disabled. Disconnect the USB-C cable immediately.

**Figure 43** USB Charging

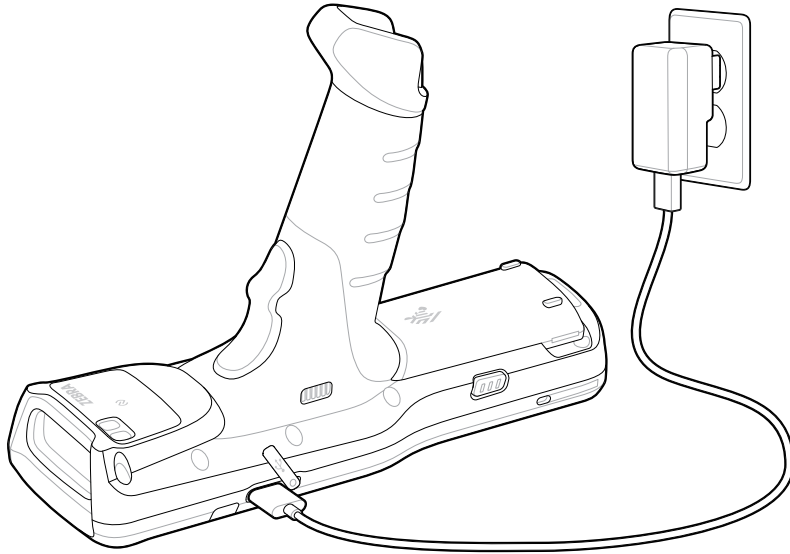

## Charge Only Adapter

Use the Charge Only Adapter for backward compatibility with the MC32N0 cradles.

The Charge Only Adapter:

- Supports the MC32N0 1-Slot USB Cradle, MC32N0 4-Slot Charge Only Cradle, and MC32N0 4-Slot Ethernet Cradle.
- Provides charge only. No communication when used with the MC32N0 cradles.

The MC32N0 1-Slot Cradle:

- Provides 5.4 VDC to charge the device.
- Compatible with PowerPrecision+ batteries.

## Installing the Charge Only Adapter

The Charge Only Adapter is for charging only (no communication) on MC32N0 1-Slot and 4-Slot cradles.

1. Clean the cradle and contacts with an alcohol wipe, using a back-and-forth motion with your finger.

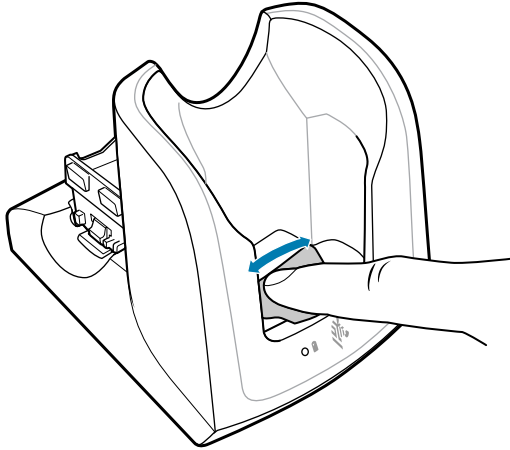

2. Peel and remove the adhesive from the back of the adapter.

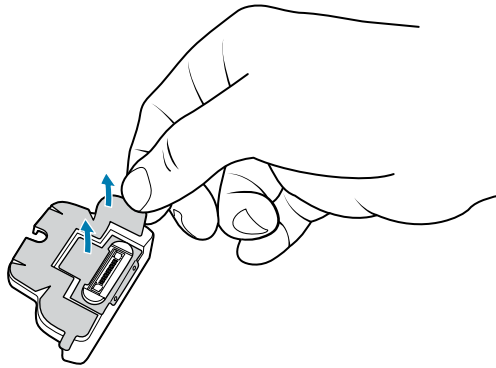

3. Insert the adapter into the MC32N0 cradle and adhere to the bottom of the cradle.

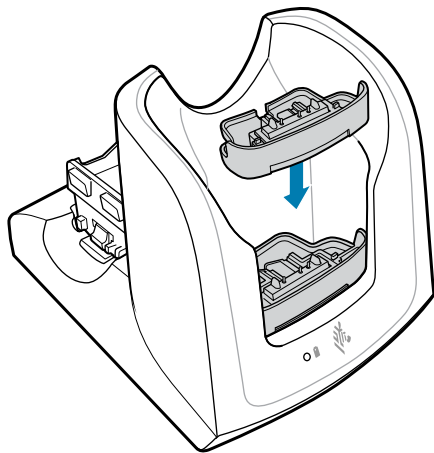



4. Insert the device into the MC32N0 cradle.



**NOTE:** To function properly, ensure that the hand strap, if attached, does not interfere with the charging contacts when the device is inserted into a charging cradle.

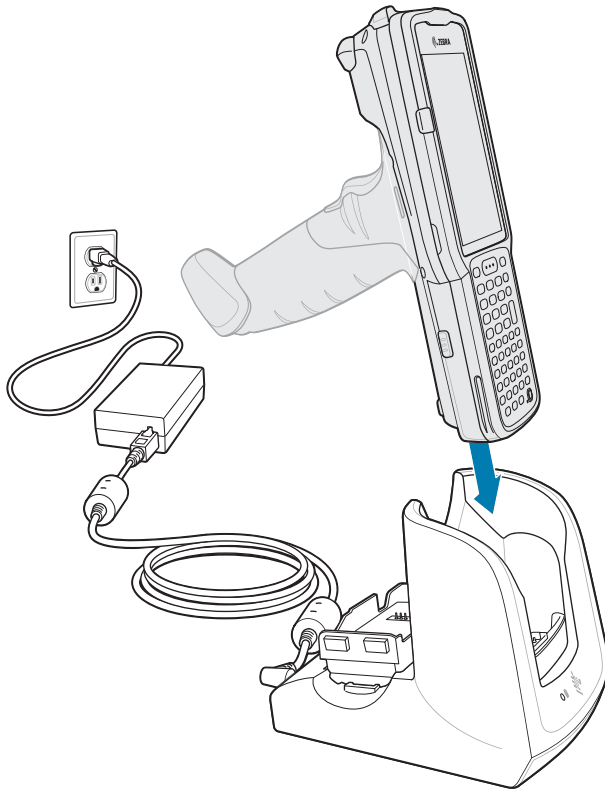

## Rubber Boot

Attaching a rubber boot to a mobile computer involves fitting a protective rubber cover over the device to safeguard it from damage.

### Installing the Rubber Boot on a Gun



**NOTE:** Remove the rubber boot before placing the device in a charging cradle or rigid holster.

1. Slide the top of the device into the top of the rubber boot.

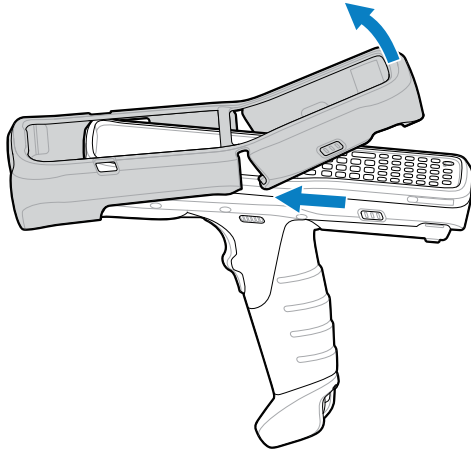

2. Grasp the bottom of the rubber boot and place it over the bottom of the device.

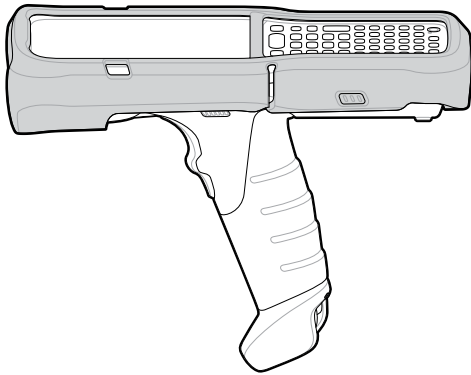

## Installing the Rubber Boot on a Straight Shooter



**NOTE:** Remove the rubber boot before placing the device in a charging cradle or rigid holster.

1. Slide the bottom of the device into the bottom of the rubber boot.

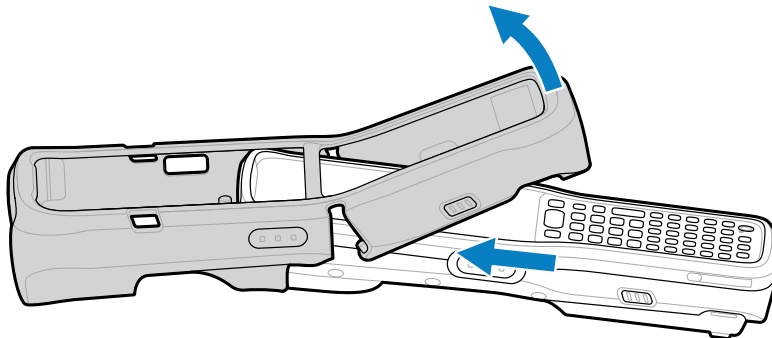

2. Grasp the top of the rubber boot and place it over the top of the device.

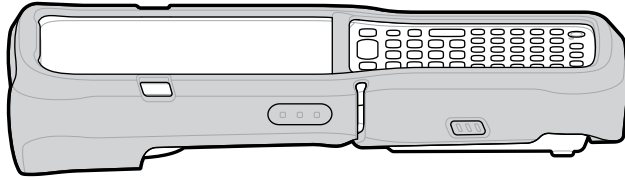

## Hand Strap

Attaching a hand strap involves securing a strap to the device to facilitate easier handling and prevent accidental drops.

### Installing a Hand Strap on a Gun

1. Thread the hand strap loop through the slot near the base of the trigger handle.

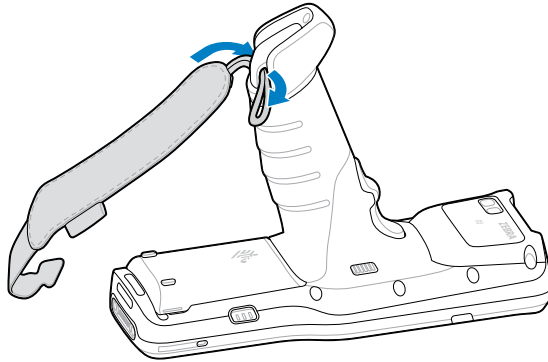

2. Insert the top end of the hand strap through the loop.

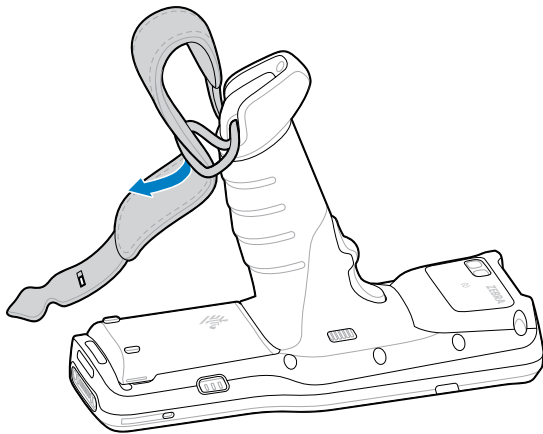

3. Pull the hand strap through the loop.

4. Thread the end of the hand strap with the tab through the slot on the bottom of the device.

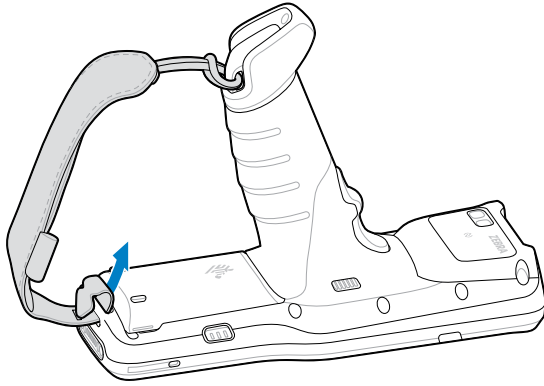

5. Slide the tab through the slit in the hand strap so that the tip of the tab is facing away from the device.

### Installing a Hand Strap on a Straight Shooter

1. Thread the end of the hand strap with the tab through the slot toward the top of the device.

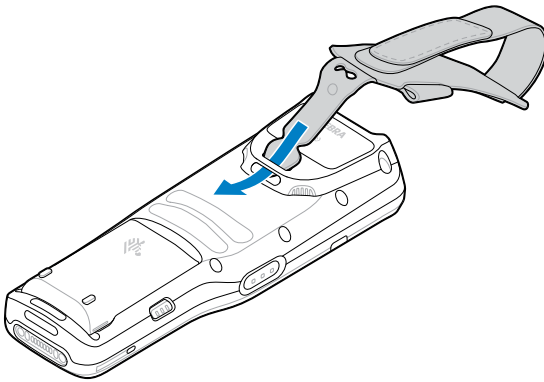

2. Slide the tab through the slit in the hand strap so that the tip of the tab is facing away from the device.

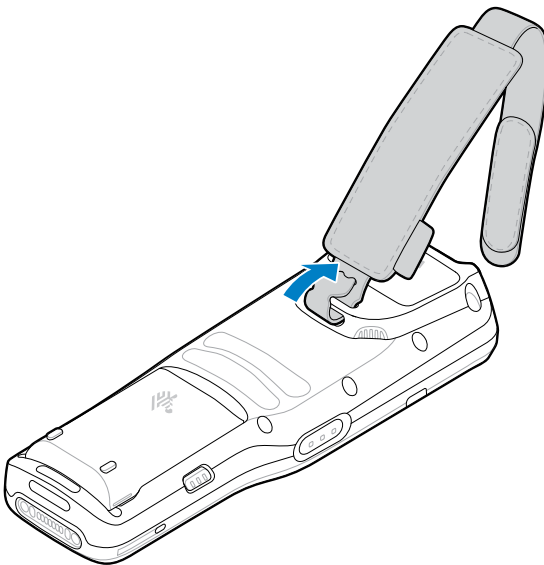

3. Thread the end of the hand strap with the velcro through the slot at the bottom of the device.

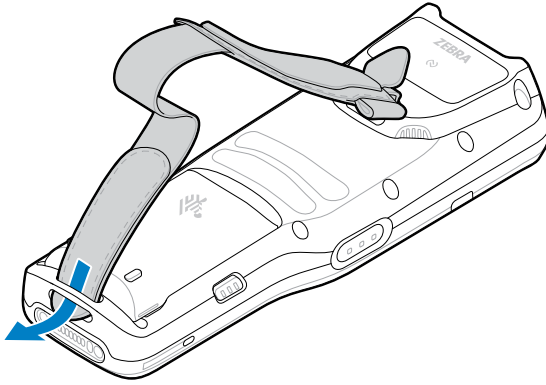

4. Pull the strap to the desired length and secure using the velcro.

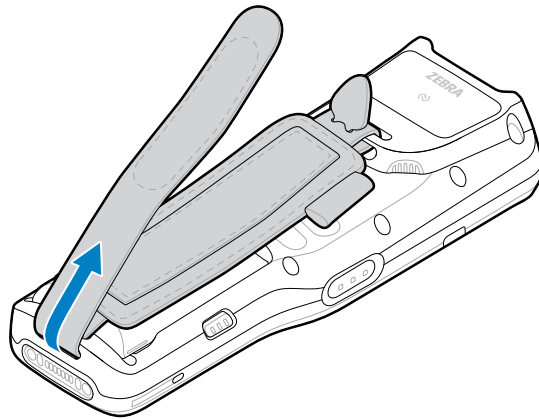

## Fabric Holster

Attaching a fabric holster to a mobile computer involves securing a fabric case to the device, providing an accessible and protective carrying solution.

### Using a Gun Belt Strap

The fabric gun belt strap holds the device on a belt or waistband.

1. Attach the fabric holster to a belt or waistband.

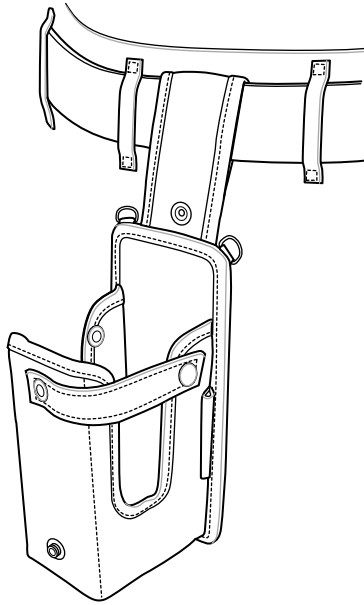

2. Secure the belt strap over the belt or waistband and snap into place.

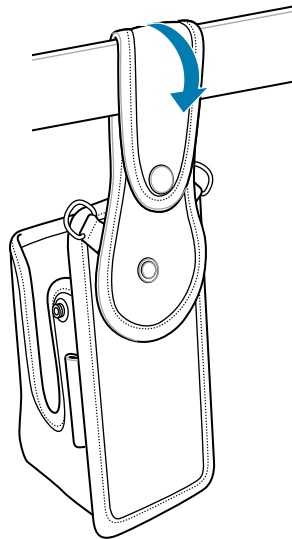

3. Slide the device into the fabric holster with the screen facing towards you.

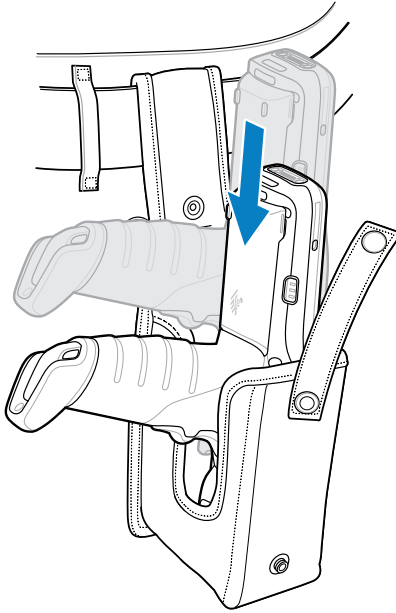

4. Secure the device with the restraining strap. Place it over the device to secure it in place.

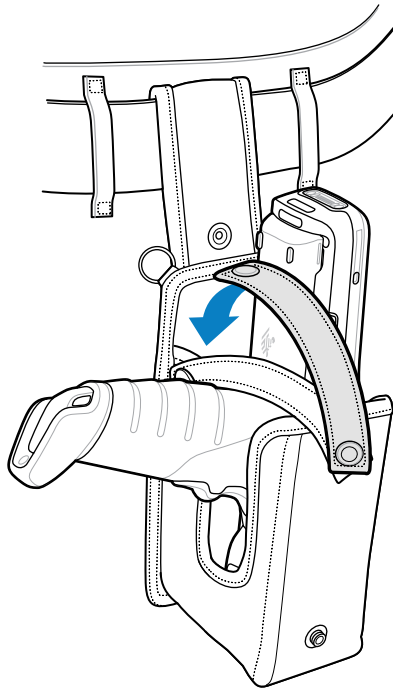

5. To remove the device from the clip, lift the restraining strap and release the device.

## Using a Straight Shooter Belt Clip

The belt clip holds the device on a belt or waistband.

1. Secure the belt clip on the fabric holster, if it is not already attached.

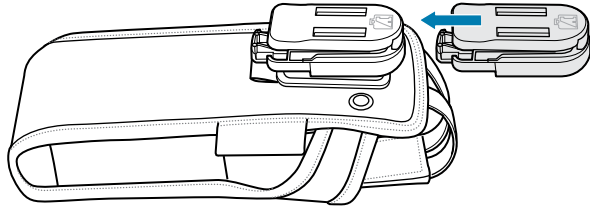

2. Secure the belt clip on the belt or waistband.

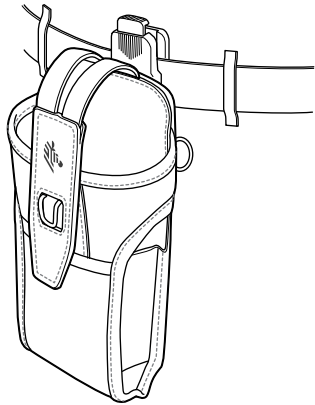

3. Slide the device into the fabric holster with the screen facing towards you.

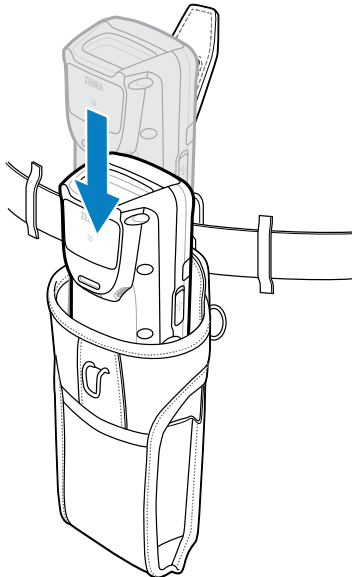



4. Secure the device with the restraining strap. Place it over the device to secure it in place.

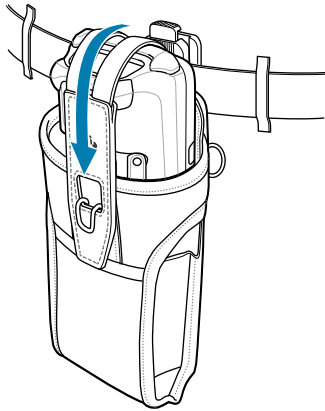

5. To remove the device from the clip, lift the restraining strap and release the device.

## Using a Shoulder Strap

Attach the fabric holster to a shoulder strap.

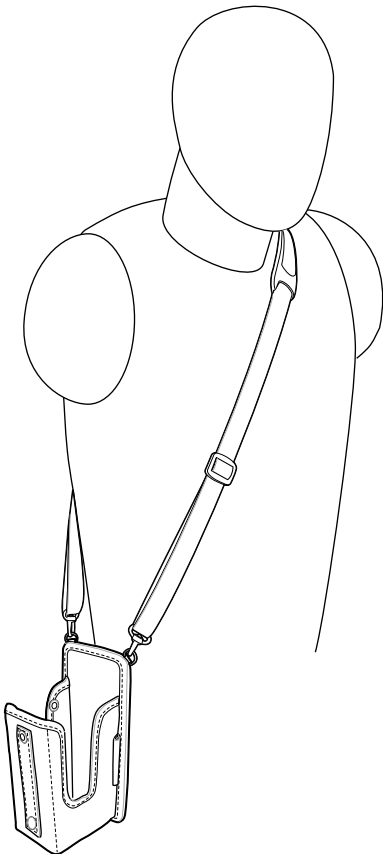

1. Connect the clips on the shoulder strap to the rings on the fabric holster.
2. Place the shoulder strap over your head and rest on your shoulder.
3. Lift the strap and insert the device into the fabric holster.

- Secure the strap to hold the device in place.

## Rigid Holster

The Rigid Holster provides a holder for the Straight Shooter configuration. It consists of a mobile computer holder and a detachable belt clip.

**Figure 44** Plastic Holder

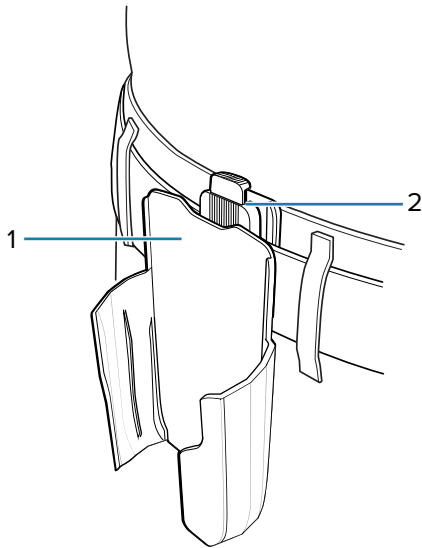

1	Mobile computer holder
2	Clip release

## Attaching the Rigid Holster

To function properly, remove the entire rubber boot from the device before placing the device in the rigid holster.

- Press the release button to remove the detachable belt clip.

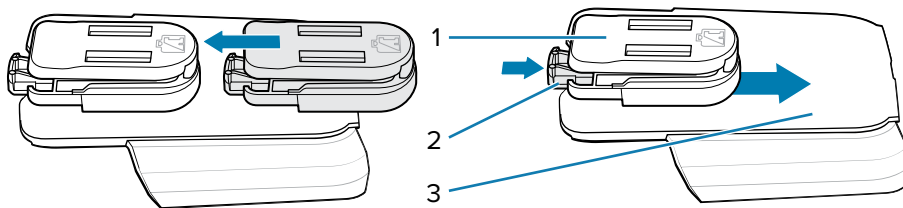

1	Detachable belt clip
2	Release button
3	Device holder

2. The holster holds the device on a belt or waistband.
  - To insert the device, slide it into the rigid holster with the screen facing towards you.
  - To remove the device, press and lift to remove the mobile computer.

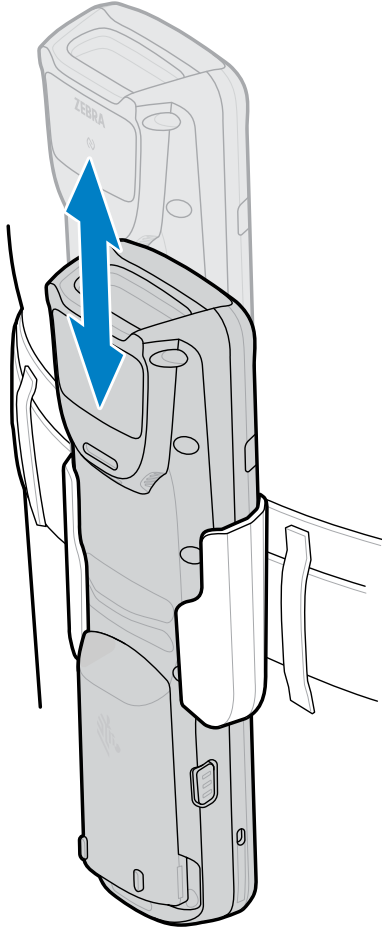

## Un-Powered Forklift Mount

The un-powered forklift mount places the MC34 in a holder while installed on a forklift. It also supports vertical (portrait) orientation.

**Figure 45** Forklift Mount

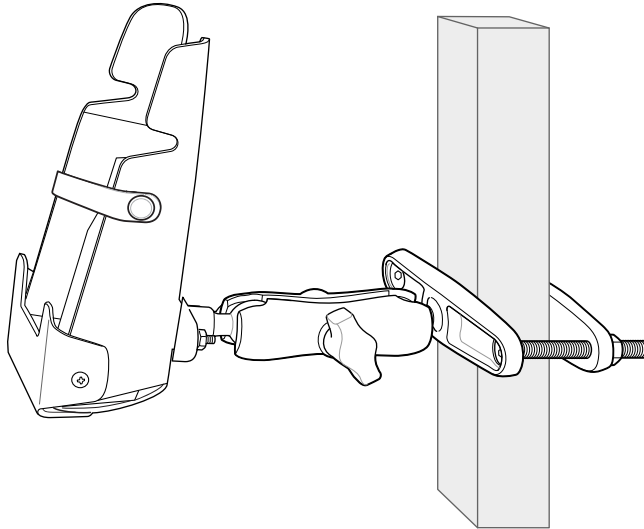

**NOTE:** When the device is on a forklift mount, it does not have access to charging or communication to the terminal.

### Installing the Device in a Forklift Mount

Install the forklift mount on a square surface or roll bar of a forklift.

To use the device in the forklift mount holder:

1. Insert the device into the holder in an upright position.

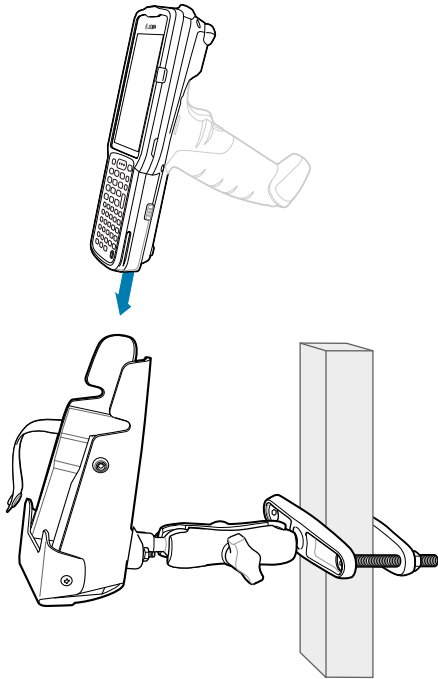

2. Secure the device with the rubber strap and snap into place.

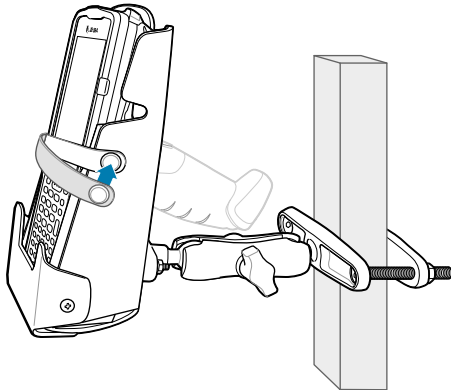

# Application Deployment

This section provides steps on device security, app development, and app management. It also provides instructions for installing apps and updating the device software.



**NOTE:** Ensure that the date is set correctly before installing certificates or when accessing secure websites.

## Security

The current Bluetooth specification defines security at the link level. Application-level security is not specified. This allows application developers to define security mechanisms tailored to their specific needs. Link-level security occurs between devices, not users, while application-level security can be implemented on a per-user basis. The Bluetooth specification defines security algorithms and procedures required to authenticate devices, and if needed, encrypt the data flowing on the link between the devices. Device authentication is a mandatory feature of Bluetooth while link encryption is optional.

Pairing of Bluetooth devices is accomplished by creating an initialization key used to authenticate the devices and create a link key for them. Entering a common personal identification number (PIN) in the devices being paired generates the initialization key. The PIN is never sent over the air. By default, the Bluetooth stack responds with no key when a key is requested (it is up to the user to respond to the key request event). Authentication of Bluetooth devices is based upon a challenge-response transaction. Bluetooth allows for a PIN or passkey used to create other 128-bit keys used for security and encryption. The encryption key is derived from the link key used to authenticate the pairing devices. Also, the limited range and fast frequency hopping of the Bluetooth radios make long-distance eavesdropping difficult.

Recommendations are:

- Perform pairing in a secure environment.
- Keep PIN codes private and do not store the PIN codes in the device.
- Implement application-level security.

## Secure Certificates

If the VPN or Wi-Fi networks rely on secure certificates, obtain the certificates and store them in the device's secure credential storage before configuring access to the VPN or Wi-Fi networks.

If downloading the certificates from a web site, set a password for the credential storage. The device supports X.509 certificates saved in PKCS#12 key store files with a .p12 extension (if key store has a .pfx or other extension, change to .p12).

The device also installs any accompanying private key or certificate authority certificates contained in the key store.

## Installing a Secure Certificate

If required by a VPN or Wi-Fi network, install a secure certificate on the device.

1. Copy the certificate from the host computer to the root of the microSD card or the device's internal memory.
2. Go to **Settings**.
3. Touch **Security > More security settings > Encryption & credentials**.
4. Touch **Install a certificate** and select the type of certificate.
5. Navigate to the location of the certificate file.
6. Touch the filename of the certificate to install.
7. If prompted, enter the certificate's password and touch **OK**.
8. Enter a name for the certificate and in the Credential use drop-down, select **VPN and apps** or **Wi-Fi**.
9. Touch **OK**.

## Configuring Credential Storage Settings

Configure credential storage from the device settings.

1. Go to **Settings**.
2. Touch **Security > Encryption & credentials**.
3. Select an option.
  - Touch **Trusted credentials** to display the trusted system and user credentials.
  - Touch **User credentials** to display user credentials.
  - Touch **Install from storage** to install a secure certificate from the microSD card or internal storage.
  - Touch **Clear credentials** to delete all secure certificates and related credentials.

## Android Development Tools

Development tools for Android include Android Studio, EMDK for Android, and StageNow.

### Android Development Workstation

Android development tools are available at [developer.android.com](http://developer.android.com).

To start developing applications for the device, download Android Studio. Development can take place on a Microsoft® Windows®, Mac® OS X®, or Linux® operating system.

Applications are written in Java or Kotlin, but compiled and executed in the Dalvik virtual machine. Once the Java code is compiled cleanly, the developer tools make sure the application is packaged properly, including the AndroidManifest.xml file.

Android Studio contains a full featured IDE as well as SDK components required to develop Android applications.

## Enabling Developer Options

Developer options set development-related settings. By default, these options are hidden.

1. Go to **Settings**.
2. Touch **About phone**.
3. Scroll down to **Build number**.
4. Tap **Build number** seven times (or as prompted by the device).  
**You are now a developer!** displays.
5. Touch **Back**.
6. Touch **System > Developer options**.

The Developer options are now displayed.

## EMDK for Android

EMDK for Android provides developers with tools to create business applications for enterprise mobile devices. It is designed for use with Google's Android Studio and includes Android class libraries such as Barcode, sample applications with source code, and the associated documentation.

EMDK for Android allows applications to take full advantage of the capabilities that Zebra devices have to offer. It embeds Profile Manager technology within Android Studio IDE, providing a GUI-based development tool designed specifically for Zebra devices. This allows fewer lines of code, resulting in reduced development time, effort, and errors.

For more information, go to [techdocs.zebra.com](http://techdocs.zebra.com).

## StageNow for Android

StageNow is Zebra's next-generation Android Staging Solution built on the MX platform. It allows quick and easy creation of device profiles and can deploy to devices simply by scanning a barcode or reading a tag.

The StageNow Staging Solution includes the following components:

- The StageNow Workstation tool installs on the staging workstation (host computer) and lets the administrator easily create staging profiles for configuring device components, and perform other staging actions such as checking the condition of a target device to determine suitability for software upgrades or other activities. The StageNow Workstation stores profiles and other created content for later use.
- The StageNow Client resides on the device and provides a user interface for the staging operator to initiate staging. The operator uses one or more of the desired staging methods (print and scan a barcode or read an NFC tag) to deliver staging material to the device.

For more information, go to [techdocs.zebra.com](http://techdocs.zebra.com).

## GMS Restricted

GMS Restricted mode deactivates Google Mobile Services (GMS). All GMS apps are disabled on the device and communication with Google (analytics data collection and location services) is disabled.

Use StageNow to disable or enable GMS Restricted mode. After a device is in GMS Restricted mode, enable and disable individual GMS apps and services using StageNow. To ensure GMS Restricted mode persists after an Enterprise Reset, use the Persist Manager option in StageNow.



For more information on StageNow, go to [techdocs.zebra.com](http://techdocs.zebra.com).

## ADB USB Setup

To use the Android Debug Bridge (ADB), install the development SDK on the host computer then install the ADB and USB drivers.

Before installing the USB driver, make sure that the development SDK is installed on the host computer. Go to [developer.android.com/sdk/index.html](http://developer.android.com/sdk/index.html) for details on setting up the development SDK.

The ADB and USB drivers for Windows and Linux are available on the Zebra Support Central web site at [zebra.com/support](http://zebra.com/support). Download the ADB and USB Driver Setup package. Follow the instructions with the package to install the ADB and USB drivers for Windows and Linux.

## Enabling USB Debugging

By default, USB debugging is disabled

Ensure that you have Developer Options enabled. Go to [Enabling Developer Options](#) for more information.

1. Touch **System > Developer options**.

2. Slide the **USB debugging** switch to the **On** position.

The **Allow USB debugging?** message displays on the device.

3. Touch **OK**.

4. Connect the device to the host computer using the rugged charge/USB cable.

The **USB debugging connected** message displays on the device.

If the device and host computer are connected for the first time, the **Allow USB debugging?** dialog box with the **Always allow from this computer** check box displays. Select the check box, if required.

5. Touch **OK** or **Allow**.

6. On the host computer, navigate to the **platform-tools** folder and open a command prompt window.

7. Type `adb devices`.

The following displays:

```
List of devices attached          XXXXXXXXXXXXXXXXXX device
```

Where XXXXXXXXXXXXXXXXXX is the device number.



**NOTE:** If device number does not appear, ensure that ADB drivers are installed properly.

8. Touch **Home**.

## Entering Android Recovery Manually

Many of the update methods discussed in this section require putting the device into Android Recovery mode. If you are unable to enter Android Recovery mode through `adb` commands, use the following steps to manually enter Android Recovery mode.

1. Press and hold the Power button until the menu appears.

2. Touch **Restart**.

3. Press and hold the Right Scan key (Straight Shooter) or the trigger (Gun) until the device vibrates. The Android Recovery screen displays.

### Application Installation Methods

After an application is developed, install the application onto the device using one of the supported methods.

- USB connection
- Android Debug Bridge
- microSD Card
- Mobile device management (MDM) platforms that have application provisioning. Refer to the MDM software documentation for details.

### Installing Applications Using the USB Connection

Use the USB connection to install applications onto the device.



**CAUTION—PRODUCT DAMAGE:** When connecting the device to a host computer and mounting the microSD card, follow the host computer's instructions for connecting and disconnecting USB devices, to avoid damaging or corrupting files.

1. Connect the device to a host computer using the Rugged Charge/USB cable.
2. On the device, pull down the Notification panel and touch **Charging this device via USB**. By default, **No data transfer** is selected.
3. Touch **File Transfer**.
4. On the host computer, open a file explorer application.
5. On the host computer, copy the application APK file from the host computer to the device.



**CAUTION—PRODUCT DAMAGE:** Carefully follow the host computer's instructions to unmount the microSD card and disconnect USB devices correctly to avoid losing information.

6. Disconnect the device from the host computer.
7. Swipe the screen up and select  to view files on the microSD card or Internal Storage.
8. Locate the application APK file.
9. Touch the application file.
10. Touch **Continue** to install the app or **Cancel** to stop the installation.
11. To confirm installation and accept what the application affects, touch **Install**. Otherwise, touch **Cancel**.
12. Touch **Open** to open the application or **Done** to exit the installation process.

The application appears in the App list.

## Installing Applications Using the Android Debug Bridge

Use ADB commands to install applications onto the device.



**CAUTION—PRODUCT DAMAGE:** When connecting the device to a host computer and mounting the microSD card, follow the host computer's instructions for connecting and disconnecting USB devices to avoid damaging or corrupting files.

1. Ensure that the ADB drivers are installed on the host computer.
2. Connect the device to a host computer using a USB cable.
3. Go to **Settings**.
4. Touch **System > Developer Options**.
5. Touch the **USB debugging** toggle to enable it.  
The **Allow USB debugging?** message appears.
6. Touch **OK**.
7. On the host computer, navigate to the **platform-tools** folder and open a command prompt window.
8. Type `adb install <application>`.  
where: <application> = the path and filename of the apk file.
9. Disconnect the device from the host computer.

## Installing Applications Using Wireless ADB

Use ADB commands to install an application onto the device.

Go to [zebra.com/support](http://zebra.com/support) and download the appropriate file to a host computer.



**NOTE:** Ensure that the latest adb files are installed on the host computer. The device and the host computer must be on the same wireless network.

1. Go to **Settings**.
2. Touch **System > Developer options**.



**NOTE:** If **Developer options** do not display, go to [Enabling Developer Options](#).

3. Touch the **USB debugging** toggle to enable it.  
The **Allow USB debugging?** message appears.
4. Touch **OK**.
5. Touch the **Wireless debugging** toggle to enable it.
  - a) If the device and host computer are connected for the first time, the **Allow wireless debugging on this network?** message displays with the **Always allow on this network** checkbox. Select the checkbox.
  - b) Touch **ALLOW**.  
The **Developer options** screen displays again but with the **Wireless debugging** enabled.
6. Touch **Wireless debugging**.  
The **Wireless debugging** screen displays.

7. Note the IP address and Port on the **Wireless debugging** screen.
8. Touch **Pair device with pairing code**.  
The **Pair with device** dialog box displays.
9. Note the port on the **Pair with device** dialog box. It will be different than the one on the **Wireless debugging** screen. The IP address will be the same.
10. On the host computer, navigate to the **platform-tools** folder and open a command prompt window.
11. Type `adb pair XX.XX.XX.XX:XXXXXX`  
where `XX.XX.XX.XX:XXXXXX` is the IP address and port number from the **Pair with device** dialog box.
12. Press **Enter**.
13. Type the pairing code from the **Pair with device** dialog box.
14. Press **Enter**.
15. Type `adb connect XX.XX.XX.XX:XXXXXX`  
where `XX.XX.XX.XX:XXXXXX` is the IP address and port number from the **Wireless debugging** screen.
16. Press **Enter**.  
The device is now connected to the host computer.
17. Type `adb devices`.  
The following displays:

```
List of devices attached      XXXXXXXXXXXXXXXXXXXX device
```

Where XXXXXXXXXXXXXXXXXXXX is the device number.



**NOTE:** If device number does not appear, ensure that ADB drivers are installed properly.



18. Press **Enter**.
19. Type `adb install <file>`.  
where `<file>` = the path and filename of the apk file.
20. Press **Enter**.
21. On the host computer, type: `adb disconnect`
22. Press **Enter**.

## Installing Applications Using a microSD Card

Use a microSD card to install applications on your device.



**CAUTION—PRODUCT DAMAGE:** When connecting the device to a host computer and mounting the microSD card, follow the host computer's instructions for connecting and disconnecting USB devices, to avoid damaging or corrupting files.

1. Copy the APK file to the root of the microSD card.
  - Copy the APK file to a microSD card using a host computer (go to [USB Communication](#) for more information), and then install the microSD card into the device (go to [Installing the microSD card](#) for more information).
  - Connect the device with a microSD card already installed to the host computer, and copy the .apk file to the microSD card. Disconnect the device from the host computer.
2. Connect the device to a host computer using USB.
3. Copy the application APK file from the host computer to the microSD card.
4. Remove the microSD card from the host computer.
5. Press and hold the Power button on the device until the menu appears.
6. Touch **Power off**.
7. Press the two battery latches in.
8. Lift the battery from the device.
9. Lift the access door.
10. Insert the microSD card.
11. Replace the access door.
12. Insert the battery, bottom first, into the battery compartment in the back of the device.
13. Press the battery down until the battery release latches snap into place.
14. Press and hold **Power** to turn on the device.
15. Swipe the screen up and select  to view files on the microSD card.
16. Touch  **SD card**.
17. Locate the application APK file.
18. Touch the application file.
19. Touch **Continue** to install the app or **Cancel** to stop the installation.
20. To confirm installation and accept what the application affects, touch **Install**. Otherwise, touch **Cancel**.
21. Touch **Open** to open the application or **Done** to exit the installation process.

The application appears in the App list.

## Uninstalling an Application

Free up device memory by removing unused apps.

1. Go to **Settings**.
2. Touch **Apps > See all ## apps**.
3. Touch the app that you want to uninstall.

Some apps were pre-installed on the device, and you cannot uninstall them. However, you can disable them (turning the app off and hiding it from the device).

4. Touch **UNINSTALL**.
5. Touch **OK** to confirm.

## Android System Update

System Update packages can contain either partial or complete updates for the operating system. Zebra distributes the System Update packages on the Zebra Support & Downloads website. Perform a system update using either a microSD card or using ADB.

### Performing a System Update Using a microSD Card

It is strongly recommended that you format the microSD card on the device before use.

Go to the [Zebra Support & Downloads](#) website and download the appropriate System Update package to a host computer.

1. Copy the System Update ZIP file to the root of the microSD card.
  - Copy the ZIP file to a microSD card using a host computer (go to [USB Communication](#) for more information), and then install the microSD card into the device (go to [Installing the microSD card](#) for more information).
  - Connect the device with a microSD card already installed to the host computer, copy the ZIP file to the microSD card, and then disconnect the device from the host computer.
2. Press and hold **Power** until the menu displays.
3. Touch **Restart**.
4. Press and hold the Right Scan key (Straight Shooter) or the trigger (Gun) until the device vibrates.  
The Android Recovery screen displays.
5. Press **Up Arrow** and **Down Arrow** to navigate to **Apply upgrade from SD card**.
6. Press **Enter**.
7. Press **Up Arrow** and **Down Arrow** to navigate to the System Update file.
8. Press **Enter** to start the system update install.  
After the installation, the device returns to the Recovery screen.
9. Navigate to **Reboot system now** and press **Enter** to reboot the device.

### Performing a System Update Using ADB

Use ADB to perform a system update.

Go to the [Zebra Support & Downloads](#) website and download the appropriate System Update package to a host computer.

1. Ensure that the ADB drivers are installed on the host computer.
2. Connect the device to a host computer using the Rugged Charge/USB cable or by inserting the device into the 1-Slot USB/Charge Only Cradle.
3. Go to **Settings**.
4. Touch **System > Developer options**.
5. Slide the **USB debugging** switch to the **ON** position.
6. If the device and host computer are connected for the first time, the **Allow USB debugging?** dialog box with the **Always allow from this computer** check box displays. Select the check box, if required.

7. Touch **OK**.
8. Type `adb devices`.  
If the device number does not appear, ensure that the ADB drivers are installed properly.
9. Type `adb reboot recovery`.
10. Press **Enter**.  
The System Recovery screen displays on the device.
11. Press **Up Arrow** and **Down Arrow** to navigate to **Apply upgrade from ADB**.
12. Press **Enter**.
13. On the host computer command prompt window type `adb sideload <file>`.  
where: <file> = the path and filename of the zip file.
14. Press **Enter**.  
The System Update installs (the progress displays as a percentage in the Command Prompt window) and then the System Recovery screen displays on the device.
15. Navigate to **Reboot system now** and press the Enter key or Power button to reboot the device.

### Verifying System Update Installation

Verify that the system update was successful.

1. Go to **Settings**.
2. Touch **About phone**.
3. Scroll down to **Build number**.
4. Ensure that the build number matches the new system update package file number.

### Android Enterprise Reset

An Enterprise Reset erases all user data in the /data partition, including data in the primary storage locations (/sdcard and emulated storage), while preserving the contents of the /enterprise folder and its subfolders. The contents of the /enterprise folder and its subfolders are preserved. Zebra distributes the Enterprise Reset packages on the Zebra Support & Downloads website.

Before performing an Enterprise Reset, provision all necessary configuration files and restore after the reset.

### Performing an Enterprise Reset From Device Settings

Perform an Enterprise Reset from the device settings.

1. Go to **Settings**.
2. Touch **System > Reset Options > Erase all data (enterprise reset)**.
3. Touch **Erase all data** twice to confirm the Enterprise Reset.

## Performing an Enterprise Reset Using a microSD Card

Performing an Enterprise Reset Using a microSD Card

Go to the [Zebra Support & Downloads](#) website and download the appropriate Enterprise Reset package to a host computer.

1. Copy the Enterprise Reset ZIP file to the root of the microSD card.
  - Copy the ZIP file to a microSD card using a host computer (go to [USB Communication](#) for more information), and then install the microSD card into the device (go to [Installing the microSD card](#) for more information).
  - Connect the device with a microSD card already installed to the host computer, copy the ZIP file to the microSD card, and then disconnect the device from the host computer.
2. Press and hold **Power** until the menu displays.
3. Touch **Restart**.
4. Press and hold the Right Scan key (Straight Shooter) or the trigger (Gun) until the device vibrates.  
The Android Recovery screen displays.
5. Press **Up Arrow** and **Down Arrow** to navigate to **Apply upgrade from SD card**.
6. Press **Enter**.
7. Press **Up Arrow** and **Down Arrow** to navigate to **Full OTA Package**.
8. Press **Enter** to start the reset.  
The reset occurs and the device returns to the Recovery screen.
9. Navigate to **Reboot system now** and press **Enter** to reboot the device.

## Performing an Enterprise Reset Using ADB

Perform an Enterprise Reset using ADB.

1. Connect the device to a host computer using the Rugged Charge/USB cable or by inserting the device into the 1-Slot USB/Charge Only Cradle.
2. Connect the cable or cradle to the host computer.
3. Go to **Settings**.
4. Touch **System > Developer options**.
5. Slide the **USB debugging** switch to the **ON** position.
6. If the device and host computer are connected for the first time, the **Allow USB debugging?** dialog box with the **Always allow from this computer** check box displays. Select the check box, if required.
7. Touch **OK**.
8. On the host computer, navigate to the **platform-tools** folder and open a command prompt window.
9. Type `adb reboot recovery`.
10. Press **Enter**.  
The System Recovery screen displays on the device.
11. Press **Volume Up** and **Volume Down** to navigate to **Apply upgrade from ADB**.



12. Press **Power**.
13. On the host computer command prompt window type `adb sideload <file>`  
where: <file> = the path and filename of the zip file.
14. Press **Enter**.  
The Enterprise Reset package installs and then the System Recovery screen appears on the device.
15. Press **Power** to reboot the device.



**NOTE:** If you cannot enter Android Recovery mode through the ADB command, go to [Entering Android Recovery Manually](#).

## Android Factory Reset

A Factory Reset erases all data in the /data and /enterprise partitions in internal storage and clears all device settings. A Factory Reset returns the device to the last installed operating system image. To revert to a previous operating system version, re-install that operating system image. Zebra distributes the Factory Reset packages on the Zebra Support & Downloads website.

### Performing a Factory Reset Using a microSD Card

Performing a Factory Reset Using a MicroSD Card

Go to the [Zebra Support & Downloads](#) website and download the appropriate Factory Reset package to a host computer.

1. Copy the Factory Reset ZIP file to the root of the microSD card.
  - Copy the ZIP file to a microSD card using a host computer (go to [USB Communication](#) for more information), and then install the microSD card into the device (go to [Installing the microSD card](#) for more information).
  - Connect the device with a microSD card already installed to the host computer, copy the ZIP file to the microSD card, and then disconnect the device from the host computer.
2. Press and hold **Power** until the menu displays.
3. Touch **Restart**.
4. Press and hold the Right Scan key (Straight Shooter) or the trigger (Gun) until the device vibrates.  
The Android Recovery screen displays.
5. Press **Up Arrow** and **Down Arrow** to navigate to **Apply upgrade from SD card**.
6. Press **Enter**.
7. Press **Up Arrow** and **Down Arrow** to navigate to **Full OTA Package**.
8. Press **Enter** to start the reset.  
The reset occurs and the device returns to the Recovery screen.
9. Navigate to **Reboot system now** and press **Enter** to reboot the device.

## Performing a Factory Reset Using ADB

Perform a Factory Reset using ADB.

1. Connect the device to a host computer using the Rugged Charge/USB cable or by inserting the device into the 1-Slot USB/Charge Only Cradle.
2. Go to **Settings**.
3. Touch **System** > **Developer options**.
4. Slide the **USB debugging** switch to the **ON** position.
5. If the device and host computer are connected for the first time, the **Allow USB debugging?** dialog box with the **Always allow from this computer** check box displays. Select the check box, if required.
6. Touch **OK**.
7. Type `adb reboot recovery`.
8. Press **Enter**.  
The System Recovery screen appears on the device.
9. Press **Volume Up** and **Volume Down** buttons to navigate to **Apply upgrade from ADB**.
10. Press **Power**.
11. On the host computer command prompt window type `adb sideload <file>`.  
where: <file> = the path and filename of the zip file.
12. Press **Enter**.  
The Factory Reset package installs, and then the System Recovery screen displays on the device.
13. Press **Power** to reboot the device.

## Android Storage

The device contains multiple types of file storage.

- Random Access Memory (RAM)
- On-device Storage
- Internal storage
- External storage (microSD card)
- Enterprise folder.



**NOTE:** It is recommended to install a microSD card on the device due to limited internal storage space.

## Random Access Memory

Executing programs use RAM to store data. Data stored in RAM is lost upon a reset.

The operating system manages how applications use RAM. It only allows applications and component processes and services to use RAM when required. It may cache recently used processes in RAM, so they restart more quickly when opened again, but it will erase the cache if it needs the RAM for new activities.

The screen displays the amount of used and free RAM.

- **Performance** - Indicates memory performance.
- **Total memory** - Indicates the total amount of RAM available.
- **Average used (%)** - Indicates the average amount of memory (as a percentage) used during the period of time selected (default - 3 hours).
- **Free** - Indicates the total amount of unused RAM.
- **Memory used by apps** - Touch to view RAM usage by individual apps.

### Viewing Memory

View the amount of memory used and free RAM.

1. Go to **Settings**.
2. Touch **System > Developer options**.
3. Touch **Memory**.

### Internal Storage

The device has internal storage. The internal storage content can be viewed and files copied to and from when the device is connected to a host computer. Some applications are designed to be stored on the internal storage rather than in internal memory.

### Viewing Internal Storage

View available and used internal storage on the device.

1. Go to **Settings**.
2. Touch **Storage**.

It displays the total amount of space on internal storage and amount used.

If the device has removable storage installed, touch **Internal shared storage** to display the amount of internal storage used by apps, photos, videos, audio, and other files.

### Enterprise Folder

The Enterprise folder (within internal flash) is a super-persistent storage that is persistent after a reset and an Enterprise Reset.

The Enterprise folder is erased during a Factory Reset. The Enterprise folder is used for deployment and device-unique data. The Enterprise folder is approximately 128 MB (formatted). Applications can persist data after an Enterprise Reset by saving data to the enterprise/user folder. The folder is ext4 formatted and is only accessible from a host computer using ADB or from an MDM.

### External Storage

The device can have a removable microSD card. The microSD card content can be viewed and files copied to and from when the device is connected to a host computer. The device can have a removable USB drive. The USB drive content can be viewed and files copied to and from when the device is connected to a host computer.

## Viewing External Storage

Portable storage displays the total amount of space on the installed microSD card or USB drive and the amount used.

1. Go to **Settings**.
2. Touch **Storage**.

Portable storage displays the total amount of space on the installed microSD card and the amount used.

3. To unmount the microSD card, touch .

Touch **SD card** to view the contents of the card.

## Formatting a microSD Card as Portable Storage

Format a microSD card as portable storage for the device.

1. Touch **SD card**.
2. Touch  > **Storage settings**.
3. Touch **Format**.
4. Touch **ERASE & FORMAT**.
5. Touch **DONE**.

## Formatting a microSD Card as Internal Memory

You can format a microSD card as internal memory to increase the actual amount of the device's internal memory. Once formatted, the microSD card can only be read by this device.



**NOTE:** The suggested maximum SD card size is 128 GB when using internal storage.

1. Touch **SD card**.
2. Touch  > **Storage settings**.
3. Touch **Format as internal**.
4. Touch **ERASE & FORMAT**.
5. Touch **DONE**.

## Managing Apps

Apps use two kinds of memory: Storage memory and RAM. Apps use storage memory for themselves and any files, settings, and other data they use. They also use RAM when they are running.

1. Go to **Settings**.
2. Touch **Apps** > **All apps**.
3. Touch  > **Show system** to include system processes in the list.
4. Touch an app, process, or service in the list to open a screen with details about it and, depending on the item, to change its settings, permissions, notifications and to force stop or uninstall it.



## App Details

Apps have different kinds of information and controls.

- **Force stop** - Stop an app.
- **Disable** - Disable an app.
- **Uninstall** - Remove the app and all of its data and settings from the device.
- **Notifications** - Set the app notification settings.
- **Permissions** - Lists the areas on the device that the app has access to.
- **Storage & cache** - Lists how much information is stored and includes buttons for clearing it.
- **Mobile data & Wi-Fi** - Provides information about data consumed by an app.
- **Mobile data & Wi-Fi** - Provides information about data consumed by an app. Mobile data not supported.
- **Advanced**
  - **Screen time** - Displays the amount of time the app has displayed on the screen.
  - **Battery** - Lists the amount of computing power used by the app.
  - **Open by default** - If you have configured an app to launch certain file types by default, you can clear that setting here.
  - **Display over other apps** - Allows an app to display on top of other apps.
  - **App details** - Provides a link to additional app details on the Play store.
  - **Additional settings in the app** - Opens settings in the app.
  - **Modify system settings** - Allows an app to modify the system settings.

## Managing Downloads

Files and apps downloaded using the browser or email are stored on the microSD card or Internal storage in the Download directory. Use the Downloads app to view, open, or delete downloaded items.

1. Swipe the screen up and touch .
2. Touch  > **Downloads**.
3. Touch and hold an item to delete, and then touch .

The item is deleted from the device.

# Keypads

The device offers three types of keypad configurations: 29 key, 38 key, and 47 key.

## 29-Key Keypad

The 29-key keypad contains a Power button, application keys, scroll keys, and function keys. The keypad is color-coded to indicate the alternate function key (blue) values and the alternate ALPHA key (orange) values. Note that an application can change keypad functions, so the mobile computer keypad may not function as described. See the tables below for key and button descriptions and keypad alternate functions.



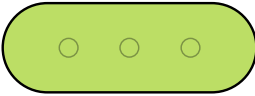







**Figure 46** 29-Key Configuration











**Table 23** 29-Key Keypad Descriptions

Key	Description
<b>Power</b> 	Powers the mobile computer screen on and off (resume and suspend).

**Table 23** 29-Key Keypad Descriptions (Continued)

Key	Description
<b>Program 1</b> 	User programmable; defaults to Back button.
<b>Diamond</b> 	Provides a 3x3 matrix on the screen with nine additional symbols. With a single tap, select via touch input or the keyboard, 1-9 numerical keys. Double-tapping the Diamond key locks the 3x3 grid, and you can select multiple keys. Pressing the Diamond key a third time closes the 3x3 matrix.
<b>Scan</b> 	Used in scanning applications, press to scan a barcode. This key has the same function as activating the side-mounted scan buttons on the Straight Shooter.
<b>Scroll Keys</b> 	Moves up, down, left, or right from one item to another. Increases/decreases specified values.
<b>ESC</b> 	Produces the ESC function. Exits the current operation.
<b>TAB</b> 	Produces the TAB function.
<b>ALT</b> 	Produces the ALT function.
<b>CTRL</b> 	Press and release the CTRL key to activate the keypad alternate CTRL functions. The <b>C</b> icon displays in the Status bar. Press and release the CTRL key two times to return to the default keypad functions.
<b>Numeric/Alpha/Special Function</b> 	Numeric, alpha, or special function keys. Numeric by default. Produces a special function when the blue function key is activated. Produces alpha values when the orange alpha key is activated. In the Alpha state, the lowercase alphabetic characters are produced on the key. Each key press produces the next alphabetic character in sequence. For example, press and release the alpha key and then press the 4 key once to produce the letter 'g'; press and release the alpha key and then press the 4 key three times to produce the letter 'i'. When the SHIFT key is pressed in the Alpha state, the upper case alphabetic characters on the key are produced. For example, press and release the alpha key, press and hold the SHIFT key and then press the 4 key once to produce the letter 'G'; press and release the alpha key, press and hold the SHIFT key and then press the 4 key three times to produce the letter 'I'.
<b>Period/Decimal Point</b> 	Produces a period for alpha entries and a decimal point for numeric entries by default.

**Table 23** 29-Key Keypad Descriptions (Continued)

Key	Description
<b>Enter</b> 	Executes a selected item or function.
<b>BKSP</b> 	Backspace function by default. Decreases volume when the blue function key is activated.
<b>SPACE</b> 	Space function by default. Increases volume when the blue function key is activated.
<b>Shift</b> 	Press and release the SHIFT key to activate the keypad alternate SHIFT functions. The  icon displays in the status bar. Press and release the SHIFT key again to return to the default keypad functions.
<b>Function</b> 	Press the orange alpha key to access the alternate alpha characters (shown on the keypad in orange). The  icon displays on the Status bar. Press and release the orange alpha key again to return to the default keypad functions.
<b>Function</b> 	Press and release the blue function key to activate the keypad alternate functions (shown on the keypad in blue). The  icon displays on the Status bar. Press and release the blue function key again to return to the default keypad functions.

## 29-Key Keypad Input Modes

The following table details the 29-key keypad input modes.



**NOTE:** An application can change the key functions. The keypad may not function exactly as described.

**Table 24** 29-Key Keypad Input Modes

Key	Numeric State		Orange Key (Alpha Lowercase State)				Orange Key + Shift Key (Alpha Uppercase State)				Blue Key
		SHIFT + Key	1st Press	2nd Press	3rd Press	4th Press	1st Press	2nd Press	3rd Press	4th Press	
1	1	!	*								F1
2	2	@	a	b	c		A	B	C		F2
3	3	#	d	e	f		D	E	F		F3
4	4	\$	g	h	i		G	H	I		F4
5	5	%	j	k	l		J	K	L		F5
6	6	^	m	n	o		M	N	O		F6
7	7	&	p	q	r	s	P	Q	R	S	F7
8	8	*	t	u	v		T	U	V		F8



**Table 24** 29-Key Keypad Input Modes (Continued)

Key	Numeric State		Orange Key (Alpha Lowercase State)				Orange Key + Shift Key (Alpha Uppercase State)				Blue Key
		SHIFT + Key	1st Press	2nd Press	3rd Press	4th Press	1st Press	2nd Press	3rd Press	4th Press	
9	9	(	w	x	y	z	W	X	Y	Z	F9
0	0	)	0				0				F10
.	.	>	.								
Backspace											Decrease Volume
Space											Increase Volume











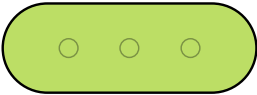

### 38-Key Keypad

The 38-key keypad contains a Power button, application keys, scroll keys, and function keys. The keypad is color-coded to indicate the alternate function key (orange) values. Note that an application can change keypad functions, so the mobile computer keypad may not function as described. The tables below provide key and button descriptions and keypad alternate functions.

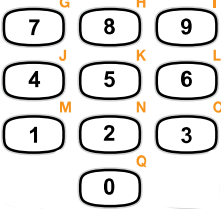





**Figure 47** 38-Key Keypad Configuration



**Table 25** 38-Key Keypad Descriptions

Key	Description
<b>Power</b> 	Powers the mobile computer screen on and off (resume and suspend).
<b>Program 1</b> 	User programmable; defaults to Back button.
<b>Diamond</b> 	Provides a 3x3 matrix on the screen with nine additional symbols. With a single tap, select via touch input or the keyboard, 1-9 numerical keys. Double-tapping the Diamond key locks the 3x3 grid, and you can select multiple keys. Pressing the Diamond key a third time closes the 3x3 matrix.
<b>Scan</b> 	Used in scanning applications, press to scan a barcode. This key has the same function as activating the side-mounted scan buttons on the Straight Shooter.
<b>Scroll Keys</b> 	Moves up, down, left, or right from one item to another.
<b>Function (Orange)</b> 	Press the orange alpha key to access the alternate alpha characters (shown on the keypad in orange). The  icon displays on the Status bar. Press and release the orange alpha key again to return to the default keypad functions.
<b>CTRL</b> 	Press and release the CTRL key to activate the keypad alternate CTRL functions. The  icon displays on the Status bar. Press and release the CTRL key again to return to the default keypad functions. Press and release the blue FUNC key and then the CTRL key to activate the ALT functions. The  icon displays on the Status bar. Press and release the CTRL key two times to return to the default keypad functions.
<b>ESC</b> 	Produces the ESC function. Exits the current operation.
<b>TAB</b> 	Produces the TAB function.
<b>ALT</b> 	Produces the ALT function.

**Table 25** 38-Key Keypad Descriptions (Continued)

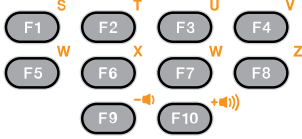
Key	Description
<p><b>Numeric/Alpha/Special Function</b></p> 	<p>Press for the default numeric value. Produces alpha values when the orange alpha key is activated.</p>
<p><b>BKSP</b></p> 	<p>Backspace function by default. Decreases brightness when the blue FUNC key is activated.</p>
<p><b>Shift</b></p> 	<p>Press and release the SHIFT key to activate the keypad alternate SHIFT functions. The  icon displays in the Status bar. Press and release the SHIFT key again to return to the default keypad functions.</p>
<p><b>Enter</b></p> 	<p>Executes a selected item or function.</p>
<p><b>Period</b></p> 	<p>Produces a period for alpha entries and a decimal point for numeric entries.</p>
<p><b>Comma</b></p> 	<p>Produces a comma by default.</p>
<p><b>F1 - F10</b></p> 	<p>Special function keys by default.</p>

### 38-Key Keypad Input Modes

The following table details the 38-key keypad input modes.



**NOTE:** An application can change the key functions. The keypad may not function exactly as described.

**Table 26** 38-Key Keypad Input Modes

Key	Normal	SHIFT + Key	Orange + Key	Orange + SHIFT
P1			F11	
Diamond			F12	
Left Arrow			a	A
Up Arrow			b	B
Down Arrow			c	C
Right Arrow			d	D
ESC				
TAB			e	E
ALT			f	F
CTRL				
7	7	&	g	G
8	8	*	h	H
9	9	(	i	I
BKSP	Backspace	Backspace	Space	Space
4	4	\$	j	J
5	5	%	k	K
6	6	^	l	L
1	1	!	m	M
2	2	@	n	N
3	3	#	o	O
,	,	<	p	P
0	0	)	q	Q
.	.		r	R
F1			s	S
F2			t	T
F3			u	U
F4			v	V
F5			w	W
F6			x	X
F7			y	Y
F8			z	Z
F9			Decrease Volume	

**Table 26** 38-Key Keypad Input Modes (Continued)

Key	Normal	SHIFT + Key	Orange + Key	Orange + SHIFT
F10			Increase Volume	

## 47-Key Keypad

The 47-key keypad contains a Power button, application keys, scroll keys, and function keys. The keypad is color-coded to indicate the alternate function key (blue) values. Note that keypad functions can be changed by an application, so the mobile computer keypad may not function as described. The tables below provide key and button descriptions and keypad alternate functions.

**Figure 48** 47-Key Keypad Configuration



**Table 27** 47-Key Keypad Descriptions















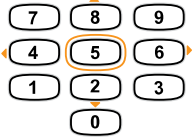

Key	Description
<b>Power</b> 	Powers the mobile computer screen on and off (resume and suspend).
<b>Program 1/ESC</b> 	User programmable; defaults to Back button. With the Shift key activated, P1 produces the ESC function.
<b>Diamond/TAB</b> 	Provides a 3x3 matrix on the screen with nine additional symbols. With a single tap, select via touch input or the keyboard, 1-9 numerical keys. Double-tapping the Diamond key locks the 3x3 grid, and you can select multiple keys. Pressing the Diamond key a third time closes the 3x3 matrix. With the Shift key activated, Diamond produces the TAB function.

Table 27 47-Key Keypad Descriptions (Continued)

Key	Description
<b>Scan (Green)</b> 	Used in scanning applications, press to scan a barcode. This key has the same function as activating the side-mounted scan buttons on the Straight Shooter.
<b>Function (Orange)</b> 	Press the orange key to access the alternate navigation and selection functions. The  icon appears on the Status bar. Press and release the orange key again to return to the default keypad functions.
<b>Numeric/Scroll/Select</b> 	Numeric, scroll, and select keys. Numeric by default. With the orange key activated, the 2, 4, 6, and 8 keys produce scroll functions, and the 5 key produces a select function.
<b>Shift</b> 	Press and release the SHIFT key to momentarily activate the keypad alternate SHIFT functions. The  icon displays on the Status bar. Press and release the SHIFT key a second time to lock the keypad into the Shift-Lock mode. The  icon appears on the Status bar. Press and release the SHIFT key again to return to the default keypad functions.
<b>Enter</b> 	Executes a selected item or function.
<b>Backspace/Space</b> 	Backspace function by default. Produces the Space function when the blue function key is activated.
<b>Period</b> 	Produces a period for alpha entries and a decimal point for numeric entries.
<b>CTRL</b> 	Press and release the CTRL key to activate the keypad alternate CTRL functions. The  icon displays on the Status bar. Press and release the CTRL key again to return to the default keypad functions. Press and release the blue function key and then the CTRL key to activate the ALT functions. The  icon displays on the Status bar. Press and release the CTRL key two times to return to the default keypad functions.

**Table 27** 47-Key Keypad Descriptions (Continued)

Key	Description
<p><b>Alpha/Special Function</b></p>	Alpha by default. Special function by default when the blue function key is activated.
<p><b>Function (Blue)</b></p>	Press and release the blue function function key to activate the keypad alternate functions (shown on the keypad in blue). The  icon displays on the Status bar. Press and release the blue function key again to return to the default keypad functions.

## 47-Key Keypad Input Modes

The following table details the 47-key keypad input modes.



**NOTE:** An application can change the key functions. The keypad may not function exactly as described.

**Table 28** 47-Key Keypad Input Modes

Key	Normal	SHIFT + Key	Blue + Key	Orange + Key
A	a	A	F1	
B	b	B	F2	
C	c	C	F3	
D	d	D	F4	
E	e	E	F5	
F	f	F	F6	
G	g	G	F7	
H	h	H	F8	
I	i	I	F9	
J	j	J	F10	
K	k	K	F11	
L	l	L	F12	
M	m	M		
N	n	N		
O	o	O		
P	p	P		

**Table 28** 47-Key Keypad Input Modes (Continued)

Key	Normal	SHIFT + Key	Blue + Key	Orange + Key
Q	q	Q		
R	r	R		
S	s	S		
T	t	T		
U	u	U		
V	v	V		
W	w	W		
X	x	X		
Y	y	Y	Decrease Volume	
Z	z	Z	Increase Volume	
Backspace	Backspace	Delete	Space	
1	1	!		
2	2	@		Down Arrow
3	3	#		
4	4	\$		Left Arrow
5	5	%		
6	6	^		Right Arrow
7	7	&		
8	8	*		Up Arrow
9	9	(		
0	0	)		
.		>		
P1			ESC	
Diamond			TAB	
CTRL			ALT	



# Maintenance and Troubleshooting

This section explains how to maintain and troubleshoot the device.

## Maintaining the Device

Follow these guidelines to maintain the device properly.

For trouble-free service, observe the following tips when using the device:

- To avoid scratching the screen, use a Zebra-approved, capacitive-compatible stylus intended for use with a touch-sensitive screen. Never use an actual pen, pencil, or other sharp object on the surface of the device screen.
- The device's touch-sensitive screen is made of glass. Do not drop the device or subject it to strong impact.
- Protect the device from temperature extremes. Do not leave it on the dashboard of a car on a hot day, and keep it away from heat sources.
- Do not store the device in any dusty, damp, or wet location.
- Use a soft lens cloth to clean the device. If the surface of the device screen becomes soiled, clean it with a soft cloth moistened with an approved cleanser.
- Periodically replace the rechargeable battery to ensure maximum battery life and product performance. Battery life depends on individual usage patterns.
- A screen protector is applied to the device. Zebra recommends using a screen protector to minimize wear and tear. Screen protectors enhance the usability and durability of touchscreen displays. Benefits include:
  - Protection from scratches and gouges
  - Durable writing and touch surface with tactile feel
  - Abrasion and chemical resistance
  - Glare reduction
  - Keeping the device's screen looking new
  - Quick and easy installation.
- Periodically inspect accessory cables and connectors. Check the inside and outside of cradles to ensure good electrical contact.

## Battery Safety Guidelines

To use the device safely, you must follow the battery guidelines.

- The area in which the units are charged should be clear of debris and combustible materials or chemicals. Particular care should be taken when the device is charged in a non-commercial environment.
- Follow the battery usage, storage, and charging guidelines found in this guide.
- Improper battery use may result in a fire, explosion, or other hazard.
- To charge the mobile device battery, the ambient battery and charger temperatures must be between +32°F and +104°F (0°C and +40°C).
- Do not use incompatible batteries and chargers, including non-Zebra batteries and chargers. Use of an incompatible battery or charger may present a risk of fire, explosion, leakage, or other hazard. If you have any questions about the compatibility of a battery or a charger, contact the Global Customer Support Center.
- For devices that utilize a USB port as a charging source, the device shall only be connected to products that bear the USB-IF logo or have completed the USB-IF compliance program.
- Do not disassemble, open, crush, bend, deform, puncture, or shred the battery.
- Severe impact from dropping any battery-operated device on a hard surface could cause the battery to overheat.
- Do not short-circuit a battery or allow metallic or conductive objects to contact the battery terminals.
- Do not modify or remanufacture, attempt to insert foreign objects into the battery, immerse or expose to water or other liquids, or expose to fire, explosion, or other hazard.
- Do not leave or store the equipment in or near areas that might get very hot, such as in a parked vehicle or near a radiator or other heat source. Do not place a battery into a microwave oven or dryer.
- Battery usage by children should be supervised.
- Please follow local regulations to properly dispose of used rechargeable batteries.
- Do not dispose of batteries in a fire.
- In the event of a battery leak, do not allow the liquid to come in contact with the skin or eyes. If contact has been made, wash the affected area with water for 15 minutes, and seek medical advice.
- If you suspect damage to your equipment or battery, contact Customer Support to arrange for inspection.

## Cleaning Instructions

Use caution and avoid damaging the device when using cleaning materials.



**CAUTION:** Always wear eye protection. Read the warning label on alcohol product before using. If you have to use any other solution for medical reasons please contact the Global Customer Support Center for more information.



**WARNING:** Avoid exposing this product to contact with hot oil or other flammable liquids. If such exposure occurs, unplug the device and clean the product immediately in accordance with these guidelines.

## Approved Cleanser Active Ingredients

100% of the active ingredients in any cleaner must consist of one or some combination of the following: isopropyl alcohol, bleach/sodium hypochlorite (see important note below), hydrogen peroxide, ammonium chloride, or mild dish soap.<sup>1</sup>



**IMPORTANT:** Use pre-moistened wipes and do not allow liquid cleaner to pool.

Due to the powerful oxidizing nature of sodium hypochlorite, the metal surfaces on the device are prone to oxidation (corrosion) when exposed to this chemical in the liquid form (including wipes). In the event that these types of disinfectants come in contact with metal on the device, prompt removal with an alcohol-dampened cloth or cotton swab after the cleaning step is critical.

Approved cleaners include:

- Purell Ethanol Wipes
- 409 Glass Cleaner
- Windex Blue
- Diversey D10 Disinfectant (1% concentration)

## Harmful Ingredients

The following chemicals are known to damage the plastics on the device and should not come in contact with the device: acetone; ketones; ethers; aromatic and chlorinated hydrocarbons; aqueous or alcoholic alkaline solutions; ethanolamine; toluene; trichloroethylene; benzene; carbolic acid and TB-lysoform.

Many vinyl gloves contain phthalate additives, which are often not recommended for medical use and are known to be harmful to the housing of the device.

## Device Cleaning Instructions

Do not apply liquid directly to the device. Dampen a soft cloth or use pre-moistened wipes. Do not wrap the device in the cloth or wipe, instead gently wipe the unit. Be careful not to let liquid pool around the display window or other places. Before use, allow the unit to air dry.



**NOTE:** For thorough cleaning, it is recommended to first remove all accessory attachments, such as hand straps or cradle cups from the mobile device and to clean them separately.

## Special Cleaning Notes

Do not handle the device while wearing vinyl gloves containing phthalates. Remove vinyl gloves and wash hands to eliminate any residue left from the gloves.

If products containing any of the harmful ingredients listed above are used prior to handling the device, such as a hand sanitizer that contains ethanolamine, hands must be completely dry before handling the device to prevent damage to the device.

<sup>1</sup> When using sodium hypochlorite (bleach) based products, always follow the manufacturer's recommended instructions: use gloves during application and remove the residue afterward with a damp alcohol cloth or a cotton swab to avoid prolonged skin contact while handling the device.



**IMPORTANT:** If the battery connectors are exposed to cleaning agents, thoroughly wipe off as much of the chemical as possible and clean with an alcohol wipe. It is also recommended to install the battery in the terminal prior to cleaning and disinfecting the device to help minimize buildup on the connectors. When using cleaning/disinfectant agents on the device, it is important to follow the directions prescribed by the cleaning/disinfectant agent manufacturer.

### Cleaning Materials Required

- Alcohol wipes with 70% isopropyl alcohol
- Lens tissue
- Cotton-tipped applicators
- 70% Isopropyl alcohol
- Can of compressed air for electronics with a dispenser tube

### Cleaning Frequency

The cleaning frequency is at the customer's discretion due to the varied environments in which the mobile devices are used and may be cleaned as frequently as required. When dirt is visible, it is recommended to clean the mobile device to avoid the build-up of particles, which makes the device more difficult to clean later on.

For consistency and optimum image capture, it is recommended to clean the camera window periodically especially when used in environments prone to dirt or dust.

### Cleaning the Device

This section describes how to clean the housing, display, and camera for the device.

For more information on cleaning the device connector, refer to [Cleaning the Connectors](#).

#### Housing

Thoroughly wipe the housing, including all buttons and triggers, using an approved alcohol wipe.

#### Display

The display can be wiped down with an approved alcohol wipe, but care should be taken not to allow any pooling of liquid around the edges of the display. Immediately dry the display with a soft, non-abrasive cloth to prevent streaking.

#### Camera and Exit Window

Wipe the camera and exit the window periodically with lens tissue or other material suitable for cleaning optical material such as eyeglasses.

#### Cleaning Battery Connectors

1. Remove the main battery from the mobile computer.
2. Dip the cotton portion of the cotton-tipped applicator in isopropyl alcohol.

3. To remove any grease or dirt, rub the cotton portion of the cotton-tipped applicator back and forth across the connectors on the battery and terminal sides. Do not leave any cotton residue on the connectors.
4. Repeat at least three times.
5. Use a dry cotton-tipped applicator and repeat steps 3 and 4. Do not leave any cotton residue on the connectors.
6. Inspect the area for any grease or dirt and repeat the cleaning process if necessary.



**CAUTION:** After cleaning the battery connectors with bleach-based chemicals, follow the Battery Connector Cleaning instructions to remove bleach from the connectors.

### Cleaning Cradle Connectors

1. Remove the DC power cable from the cradle.
2. Dip the cotton portion of the cotton-tipped applicator in isopropyl alcohol.
3. Rub the cotton portion of the cotton-tipped applicator along the pins of the connector. Slowly move the applicator back and forth from one side of the connector to the other. Do not leave any cotton residue on the connector.
4. All sides of the connector should also be rubbed with the cotton-tipped applicator.
5. Remove any lint left by the cotton-tipped applicator.
6. If grease and other dirt can be found on other areas of the cradle, use a lint-free cloth and alcohol to remove.
7. Allow at least 10 to 30 minutes (depending on ambient temperature and humidity) for the alcohol to air dry before applying power to cradle.

If the temperature is low and humidity is high, longer drying time is required. Warm temperature and low humidity requires less drying time.



**CAUTION:** After cleaning the cradle connectors with bleach-based chemicals, follow the Cleaning Cradle Connectors instructions to remove bleach from the connectors.

### Troubleshooting

This section provides information for resetting and troubleshooting the device and accessories.

#### Resetting the Device

There are two reset functions: soft reset and hard reset.

##### Performing a Soft Reset

Perform a soft reset if applications stop responding.

1. Press and hold Power until the menu appears.
2. Touch **Restart**.

The device reboots.

## Performing a Hard Reset

Perform a hard reset if the device stops responding.



**CAUTION:** Performing a hard reset with a microSD card installed in the device may cause damage or data corruption to the microSD card.

1. Simultaneously press the Power, left scan, and Volume Up buttons for at least 4 seconds.
2. When the screen turns off, release the buttons.

The device reboots.

## Troubleshooting the Device

The following table provides typical problems that might arise and the solution for correcting the problem.

Problem	Cause	Solution
When pressing the power button the device does not turn on.	The battery is not charged.	Charge or replace the battery in the device.
	The battery is not installed properly.	Install the battery properly.
	System crash.	Perform a reset.
The battery did not charge.	Battery failed.	Replace battery. If the device still does not operate, perform a reset. See <a href="#">Resetting the Device</a> .
	The device was removed from the cradle while the battery was charging.	Insert the device in the cradle and begin charging. The 7,000 mAh PowerPrecision+ extended battery charges from 0% to 90% in less than 5.2 hours at room temperature. The 5,200 mAh PowerPrecision+ high-capacity battery charges from 0% to 90% in less than 3.8 hours at room temperature.
	Extreme battery temperature.	The battery does not charge if the ambient charging temperature is below 0°C (32°F) or above 40°C (104°F).
Cannot see characters on display.	The device is not powered on.	Press the Power button.
During data communication with a host computer, no data transmitted, or transmitted data was incomplete.	The device is removed from the cradle or disconnected from the host computer during communication.	Replace the device in the cradle, or reattach the communication cable and re-transmit.
	Incorrect cable configuration.	See the system administrator.
The device does not emit sound.	The volume setting is low or turned off.	Click on the speaker icon to increase the volume.
The device turns itself off.	The device is inactive.	The display turns off after a period of inactivity. Set this period from 15 seconds to Never.
	The battery is depleted.	Recharge or replace the battery.

Problem	Cause	Solution
A message displays that the device's memory is full.	Too many applications are installed on the device.	Remove user-installed applications on the device to recover memory. Select <b>Settings &gt; Apps</b> . Select the unused program(s) and tap <b>Uninstall</b> .
The device does not decode with a reading barcode.	DataWedge is not enabled.	Ensure that DataWedge is enabled and configured properly.
	Unreadable barcode.	Ensure the symbol is not defaced.
	The distance between the exit window and the barcode is incorrect.	Place the device within the proper scanning range.
	The device is not programmed for the barcode type.	Program the device to accept the type of barcode being scanned.
	The device is not programmed to generate a beep.	If the device does not beep on a good decode, set the application to generate a beep on a good decode.
Device cannot find any Bluetooth devices nearby.	Too far from other Bluetooth devices.	Move closer to the other Bluetooth device(s), within a range of 10 meters (32.8 feet).
	The Bluetooth device(s) nearby are not turned on.	Turn on the Bluetooth device(s) to find.
	The Bluetooth device(s) are not in discoverable mode.	Set the Bluetooth device(s) to discoverable mode. If needed, refer to the device's user documentation for help.
Cannot connect to WLAN (on channels 12-13 and all 5 GHz channels).	Access Point (AP) does not broadcast country code.	Disable 802.11d feature. Go to <b>Settings &gt; Wi-Fi &gt; Additional settings &gt; Country Selection</b> . A warning window pops up indicating you must select the country in which you are using the device. This enables all channels for the selected country even if the AP does not broadcast the country code.
When trying to open files or other applications, the application automatically closes.	The internal memory is full.	Connect the device to a host computer and delete files from Internal Memory using the host computer.

## 1-Slot USB Charge Cradle Troubleshooting

This table provides troubleshooting options for the cradle.

Symptom	Possible Cause	Action
The device Charge LED indicator does not light when the device is inserted.	The cradle is not receiving power.	Ensure the power cable is connected securely to both the cradle and to AC power.
	The device is not correctly seated.	Remove and re-insert the device into the cradle, ensuring it is correctly seated.
The spare Battery Charging LED does not light when the spare battery is inserted.	The spare battery is not correctly seated.	Remove and re-insert the spare battery into the cradle, ensuring it is correctly seated.

Symptom	Possible Cause	Action
The device battery is not charging.	The device was removed from the cradle, or the cradle was unplugged from AC power too soon.	Ensure the cradle is receiving power. Ensure the device is seated correctly. The 7,000 mAh PowerPrecision+ extended battery charges from 0% to 90% in less than 5.2 hours at room temperature. The 5,200 mAh PowerPrecision+ high-capacity battery charges from 0% to 90% in less than 3.8 hours at room temperature.
	The battery is faulty.	Verify that other batteries charge properly. If so, replace the faulty battery.
	The device is not fully seated in the cradle.	Remove and re-insert the device into the cradle, ensuring it is firmly seated.
	Extreme battery temperature.	The battery does not charge if the ambient temperature is below 5°C (40°F) or above 40°C (104°F).
The spare battery is not charging.	The battery is not fully seated in the charging slot.	Remove and re-insert the spare battery in the cradle, ensuring it is firmly seated.
	The battery was inserted incorrectly.	Re-insert the battery so the charging contacts on the battery align with the contacts on the cradle. Ensure the contacts are facing down and toward the back of the cradle.
	The battery is faulty.	Verify that other batteries charge properly. If so, replace the faulty battery.
During data communication, no data was transmitted, or transmitted data was incomplete.	The device was removed from the cradle during communication.	Replace the device in the cradle and retransmit.
	Incorrect cable configuration.	See the system administrator.
	Communication software is not installed or configured properly.	See the system administrator.

## 5-Slot Charge Only ShareCradle Troubleshooting

This table provides troubleshooting options for the cradle.

Problem	Cause	Solution
The device Charge LED indicator does not light when the device is inserted.	The cradle is not receiving power.	Replace the device in the cradle. Go to <b>Settings &gt; About phone &gt; Battery Information &gt; Charge Status</b> to view battery status.
	The battery is faulty.	Verify that other batteries charge properly. If so, replace the faulty battery.
	The device is not inserted correctly in the cradle.	Remove the device and reinsert it correctly. Verify charging is active. Go to <b>Settings &gt; About phone &gt; Battery Information &gt; Charge Status</b> to view battery status.



Problem	Cause	Solution
	The ambient temperature of the cradle is too warm.	Move the cradle to an area where the ambient temperature is between 0°C (32°F) and 35°C (95°F).
The device Charge LED indicator is a fast-blinking red when the device is inserted.	The ambient temperature of the cradle is too low or too high.	Move the cradle to an area where the ambient temperature is between 0°C (32°F) and 35°C (95°F).
	Charging has gone on too long without completion (typically eight hours).	Verify that other batteries charge properly. If so, replace the faulty battery.

## 5-Slot Ethernet ShareCradle Troubleshooting

This table provides troubleshooting options for the cradle.

Problem	Cause	Solution
The device Charge LED indicator does not light when the device is inserted.	The cradle is not receiving power.	Replace the device in the cradle. Go to <b>Settings &gt; About phone &gt; Battery Information &gt; Charge Status</b> to view battery status.
	The battery is faulty.	Verify that other batteries charge properly. If so, replace the faulty battery.
	The device is not inserted correctly in the cradle.	Remove the device and reinsert it correctly. Verify charging is active. Go to <b>Settings &gt; About phone &gt; Battery Information &gt; Charge Status</b> to view battery status.
	The ambient temperature of the cradle is too warm.	Move the cradle to an area where the ambient temperature is between 0°C (32°F) and 35°C (95°F).
The device Charge LED indicator is a fast-blinking red when the device is inserted.	The ambient temperature of the cradle is too low or too high.	Move the cradle to an area where the ambient temperature is between 0°C (32°F) and 35°C (95°F).
	Charging has gone on too long without completion (typically eight hours).	Verify that other batteries charge properly. If so, replace the faulty battery.

## 5-Slot Charge Only ShareCradle with 4-Slot Battery Charger Troubleshooting

This table provides troubleshooting options for the cradle.

Problem	Cause	Solution
The device Charge LED indicator does not light when the device is inserted.	The cradle is not receiving power.	Replace the device in the cradle. Go to <b>Settings &gt; About phone &gt; Battery Information &gt; Charge Status</b> to view battery status.
	The battery is faulty.	Verify that other batteries charge properly. If so, replace the faulty battery.
	The device is not inserted correctly in the cradle.	Remove the device and reinsert it correctly. Verify charging is active. Go to <b>Settings &gt; About phone &gt; Battery Information &gt; Charge Status</b> to view battery status.
	The ambient temperature of the cradle is too warm.	Move the cradle to an area where the ambient temperature is between 0°C (32°F) and 35°C (95°F).
The device Charge LED indicator is a fast-blinking red when the device is inserted.	The ambient temperature of the cradle is too low or too high.	Move the cradle to an area where the ambient temperature is between 0°C (32°F) and 35°C (95°F).
	Charging has gone on too long without completion (typically eight hours).	Verify that other batteries charge properly. If so, replace the faulty battery.
The spare Battery Charging LED does not light when the spare battery is inserted.	The spare battery is not correctly seated.	Remove and re-insert the spare battery into the cradle, ensuring it is seated correctly.
The spare battery is not charging.	The battery is not fully seated in the charging slot.	Remove and re-insert the spare battery into the cradle, ensuring it is correctly seated.
	The battery was inserted incorrectly.	Ensure the contacts are facing down and toward the back of the cradle.

## 5-Slot Ethernet ShareCradle with 4-Slot Battery Charger Troubleshooting

This table provides troubleshooting options for the cradle.

Problem	Cause	Solution
The device Charge LED indicator does not light when the device is inserted.	The cradle is not receiving power.	Replace the device in the cradle. Go to <b>Settings &gt; About phone &gt; Battery Information &gt; Charge Status</b> to view battery status.
	The battery is faulty.	Verify that other batteries charge properly. If so, replace the faulty battery.

Problem	Cause	Solution
	The device is not inserted correctly in the cradle.	Remove the device and reinsert it correctly. Verify charging is active. Go to <b>Settings &gt; About phone &gt; Battery Information &gt; Charge Status</b> to view battery status.
	The ambient temperature of the cradle is too warm.	Move the cradle to an area where the ambient temperature is between 0°C (32°F) and 35°C (95°F).
The device Charge LED indicator is a fast-blinking red when the device is inserted.	The ambient temperature of the cradle is too low or too high.	Move the cradle to an area where the ambient temperature is between 0°C (32°F) and 35°C (95°F).
	Charging has gone on too long without completion (typically eight hours).	Verify that other batteries charge properly. If so, replace the faulty battery.
The spare Battery Charging LED does not light when the spare battery is inserted.	The spare battery is not correctly seated.	Remove and re-insert the spare battery into the cradle, ensuring it is seated correctly.
The spare battery is not charging.	The battery is not fully seated in the charging slot.	Remove and re-insert the spare battery into the cradle, ensuring it is correctly seated.
	The battery was inserted incorrectly.	Ensure the contacts are facing down and toward the back of the cradle.

## 4-Slot Spare Battery Charger Troubleshooting

This table provides troubleshooting options for the charger.

Problem	Cause	Solution
The spare Battery Charging LED does not light when the spare battery is inserted.	The spare battery is not correctly seated.	Remove and re-insert the spare battery into the cradle, ensuring it is seated correctly.
The spare battery is not charging.	The charger is not receiving power.	Ensure the power cable is connected securely to both the charger and to AC power.
	The spare battery is not correctly seated.	Remove and re-insert the battery into the cradle, ensuring it is correctly seated.

Problem	Cause	Solution
	The battery was removed from the charger, or the charger was unplugged from AC power too soon.	Ensure the charger is receiving power. Ensure the spare battery is seated correctly. The 7,000 mAh PowerPrecision+ extended battery charges from 0% to 90% in less than 5.2 hours at room temperature. The 5,200 mAh PowerPrecision+ high-capacity battery charges from 0% to 90% in less than 3.8 hours at room temperature.
	The battery is faulty.	Verify that other batteries charge properly. If so, replace the faulty battery.

## 20-Slot Spare Battery Charger Troubleshooting

This table provides troubleshooting options for the charger.

Problem	Cause	Solution
The spare Battery Charging LED does not light when the spare battery is inserted.	The spare battery is not correctly seated.	Remove and re-insert the spare battery into the cradle, ensuring it is seated correctly.
The spare battery is not charging.	The charger is not receiving power.	Ensure the power cable is connected securely to both the charger and to AC power.
	The spare battery is not correctly seated.	Remove and re-insert the battery into the cradle, ensuring it is correctly seated.
	The battery was removed from the charger, or the charger was unplugged from AC power too soon.	Ensure the charger is receiving power. Ensure the spare battery is seated correctly. The 7,000 mAh PowerPrecision+ extended battery charges from 0% to 90% in less than 5.2 hours at room temperature. The 5,200 mAh PowerPrecision+ high-capacity battery charges from 0% to 90% in less than 3.8 hours at room temperature.
	The battery is faulty.	Verify that other batteries charge properly. If so, replace the faulty battery.

## USB Charge Cable Troubleshooting

This table provides troubleshooting options for the USB Charge Cable.

Symptom	Possible Cause	Action
The device Charge LED indicator does not light when the device is attached.	The cable is not receiving power.	Ensure the power cable is connected securely to both the cable and to AC power.
	The device is not seated correctly in the cable cup.	Remove and re-insert the device into the cable cup, ensuring it is correctly seated.

Symptom	Possible Cause	Action
The device battery is not charging.	The device was detached from the cable, or the cable was unplugged from AC power too soon.	Ensure cable is receiving power. Ensure device is seated correctly. The 7,000 mAh PowerPrecision+ extended battery charges from 0% to 90% in less than 5.2 hours at room temperature. The 5,200 mAh PowerPrecision+ high capacity battery charges from 0% to 90% in less than 3.8 hours at room temperature.
	The battery is faulty.	Verify that other batteries charge properly. If so, replace the faulty battery.
	The device is not fully seated in the cable.	Remove and re-insert the device into the cradle, ensuring it is firmly seated.
During data communication, no data was transmitted, or transmitted data was incomplete.	The cable was disconnected from the device during communications.	Re-attach the cable and retransmit.
	Incorrect cable configuration.	See the system administrator.
	Communication software is not installed or configured properly.	See the system administrator.

# Specifications

For device technical specifications, go to [zebra.com/support](http://zebra.com/support).

## Data Capture Supported Symbologies

**Table 29** Data Capture Supported Symbologies

Item	Description
1D Bar Codes	Chinese 2 of 5, Codabar, Code 11, Code 128, Code 39, Code 93, Discrete 2 of 5, EAN-8, EAN-13, GS1 DataBar, GS1 DataBar Expanded, GS1 DataBar Limited, Interleaved 2 of 5, Korean 2 of 5, MSI, TLC 39, Matrix 2 of 5, Trioptic, UPCA, UPCE, UPCE1, Web Code.
2D Bar Codes	Australian Post, Aztec, Canadian Postal, Composite AB, Composite C, DataMatrix, DotCode, Dutch Postal, Japan Postal, Maxicode, Micro PDF, Micro QR Code, PDF-417, QR Code, UK Postal, US Planet, US Postnet, US4State, US4State FICS.

## SE4710 Decode Zones

This table lists the typical distances for selected barcode densities. The minimum element width (or “symbol density”) is the width in mils of the narrowest element (bar or space) in the symbol.

Symbol Density/Bar Code Type	Typical Working Ranges	
	Near	Far
4 mil Code 39	3.3 in. (8.4 cm)	8.8 in. (22.4 cm)
5 mil Code 128	2.8 in. (7.1 cm)	8.2 in. (20.8 cm)
5 mil Code 39	2.0 in. (5.08 cm)	13.5 in. (34.3 cm)
5 mil PDF417	3.1 in. (7.9 cm)	8.4 in. (21.3cm)
10 mil Data Matrix	2.9 in. (7.4 cm)	10.1 in. (25.7cm)
100% UPCA	1.8 in. (4.6 cm)*	26.0 in. (66 cm)
20 mil Code 39	2.0 in. (5.08 cm)*	30.0 in. (76.2 cm)

## Specifications

Symbol Density/Bar Code Type	Typical Working Ranges	
	Near	Far
*Limited by width of barcode in field of view. Photographic quality barcode at 18° tilt pitch angle under 30 fcd ambient illumination.		

### SE4770 Decode Zones

This table lists the typical distances for selected barcode densities. The minimum element width (or “symbol density”) is the width in mils of the narrowest element (bar or space) in the symbol.

Symbol Density/Bar Code Type	Typical Working Ranges	
	Near	Far
3 mil Code 39	3.0 in. (7.6 cm)	5.8 in. (14.7 cm)
5.0 mil Code 128	2.3 in. (5.8 cm)	9.8 in. (24.9 cm)
5 mil PDF417	3.0 in. (7.6 cm)	7.9 in. (20.1 cm)
6.67 mil PDF417	2.5 in. (6.3 cm)	10.1 in. (25.7 cm)
10 mil Data Matrix	2.1 in. (5.3 cm)	11.0 in. (27.8 cm)
100% UPCA	1.6 in. (4.1 cm)	24.9 in. (63.2 cm)
15 mil Code 128	2.4 in. (6.0 cm)	27.8 in. (70.6 cm)
20 mil Code 39	1.6 in. (4.0 cm)	36.1 in. (91.7 cm)
20 mile QR Code	1.1 in. (2.8 cm)	17.5 in. (44.5 cm)
Photographic quality barcode at 18° tilt pitch angle under 30 fcd ambient illumination.		

### SE55-AR Decode Zones

This table lists the typical distances for selected barcode densities

Symbol Density/ Bar Code Type	Typical Working Ranges	
	Near	Far
3 mil Code 39	6.9 cm (2.7 in.)	41.1 cm (16.2 in.)
5 mil Code 39	6.4 cm (2.5 in.)	67.6 cm (26.6 in.)
5 mil PDF417	7.1 cm (2.8 in.)	49.9 cm (19.6 in.)
6.67 mil PDF417	6.6 cm (2.6 in.)	65.0 cm (25.6 in.)
80% UPCA	5.0 cm* (2.0 in.)	141.0 cm (55.5 in.)
100% UPCA	6.4 cm* (2.5 in.)	180.0 cm (71.0 in.)
10 mil Data Matrix	5.6 cm* (2.2 in.)	68.8 cm (27.1 in.)
15 mil Code 128 (4 in. wide)	18.2 cm* (7.2 in.)	181.0 cm (72.0 in.)
20 mil Code 39	*	277.0 cm (109.0 in.)
55 mil Code 39	*	744.0 cm (293.0 in.)
100 mil Code 39	*	1407.0 cm (554.0 in.)

## Specifications

Symbol Density/ Bar Code Type	Typical Working Ranges	
	Near	Far
*Limited by width of barcode in field of view.		

### SE58-ER Decode Zones

This table lists the typical distances for selected barcode densities.

Symbology	Typical Working Range	
	Near	Far
5 mil Code 39 2.5:1	2.0 in. (5.1 cm)	59 in. (150 cm)
5 mil PDF	3.5 in. (8.9 cm)	43 in. (109 cm)
6.67 mil PDF	2.8 in. (7.1 cm)	57 in. (145 cm)
10 mil PDF	1.9 in. (4.8 cm)	77 in. (196 cm)
10 mil Data Matrix	2.4 in. (6.1 cm)	62 in. (157 cm)
10 mil QR	2.4 in. (6.1 cm)	56 in. (142 cm)
80% UPCA	1.9 in. (4.8 cm)	110 in. (279 cm)
100% UPCA	2.2 in. (5.6 cm)	139 in. (353 cm)
15 mil Code 128 4 in. wide	5.8 in. (14.7 cm)	159 in. (404 cm)
20 mil Code 39 2.2:1	*	230 in. (584 cm)
40 mil Code 39 2.5:1	*	491 in. (1247 cm)
55 mil Code 39 3:1	*	702 in. (178 cm)
55 mil QR	*	290 in. (737 cm)
100 mil Code 39, 3:1, 203 mm (8 in.) height	*	1286 in. (327 cm)
100 mil Code 39, 3:1 RFL, 152 mm (6 in.) height	*	1217 in. (309 cm)
100 mil C128 RFL, 152 mm (6 in.) height	*	1006 in. (256 cm)
* Limited by width of barcode in field of view. Refer to the SE58 Integration Guide for details. Photographic quality barcode at 18° tilt pitch angle under 20 fcd ambient illumination. Distances measured from the front edge of the scan engine chassis.		



## Accessory Specifications

This section provides the specifications for the device's accessories.

### Connector Pin-Out

**Figure 49** MC34 Input/Output (I/O) Connector

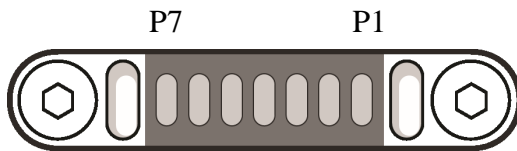

**Table 30** I/O Connector Pin-Outs

Pin	Signal	Description
1	Ground (GND)	Ground pin is connected to the Cradle or USB Charge Cable ground.
2	USB ID	Identification signal for USI OTG communication (USB ID) that determines USB mode (host or device).
3	POWER_IN_CON (9V/1.5A or 5V/2Amax)	DC power supply from the Cradle.
4	USB PWR	Power supply from USB Charging Cable.
5	USB D-	USB OTG data signal negative.
6	USB D+	USB OTG data signal positive.
7	Ground (GND)	Ground pin connected to the Cradle or USB Charge Cable ground.

## 1-Slot USB Charge Cradle with Spare Battery Charger Technical Specifications

**Table 31** 1-Slot USB Charge Cradle with Spare Battery Charger Technical Specifications

Item	Description
Dimensions	Height: 104.5 mm (4.11 in) Width: 99.1 mm (3.90 in) Depth: 155.5 mm (6.12 in)
Weight	376 g (13.28 oz)
Input Voltage	12 VDC
Power Consumption	17 watts
Operating Temperature	0°C to 40°C (32°F to 104°F)
Storage Temperature	-40°C to 70°C (-40°F to 158°F)
Charging Temperature	0°C to 40°C (32°F to 104°F)
Humidity	10% to 95% non-condensing

**Table 31** 1-Slot USB Charge Cradle with Spare Battery Charger Technical Specifications (Continued)

Item	Description
Drop	75 cm (30 in.) to concrete; 2 drops/side for a total of 12 drops at room temperature (23°C).
Electrostatic Discharge (ESD)	+/- 20 kV air +/- 10 kV contact +/- 10 kV indirect discharge

## 5-Slot Charge Only ShareCradle Technical Specifications

**Table 32** 5-Slot Charge Only ShareCradle Technical Specifications

Item	Description
Dimensions	Height: 123.9 mm (4.88 in) Width: 489.0 mm (19.25 in) Depth: 142.8 mm (5.6232 in)
Weight	2.49 kgs (5.5 lbs)
Input Voltage	12 VDC
Power Consumption	45 watts
Operating Temperature	0°C to 40°C (32°F to 104°F)
Storage Temperature	-40°C to 70°C (-40°F to 158°F)
Charging Temperature	0°C to 40°C (32°F to 104°F)
Humidity	10% to 95% non-condensing
Drop	75 cm (30 in.) to concrete; 2 drops/side for a total of 12 drops at room temperature (23°C).
Electrostatic Discharge (ESD)	+/- 20 kV air +/- 10 kV contact +/- 10 kV indirect discharge

## 5-Slot Ethernet ShareCradle Technical Specifications

**Table 33** 5-Slot Ethernet ShareCradle Technical Specifications

Item	Description
Dimensions	Height: 123.9 mm (4.88 in) Width: 489.0 mm (19.25 in) Depth: 142.8 mm (5.622 in)
Weight	2.59 kgs (5.7 lbs)
Input Voltage	12 VDC
Power Consumption	47 watts
Operating Temperature	0°C to 40°C (32°F to 104°F)
Storage Temperature	-40°C to 70°C (-40°F to 158°F)
Charging Temperature	0°C to 40°C (32°F to 104°F)
Humidity	10% to 95% non-condensing
Drop	75 cm (30 in.) to concrete; 2 drops/side for a total of 12 drops at room temperature (23°C).

**Table 33** 5-Slot Ethernet ShareCradle Technical Specifications (Continued)

Item	Description
Electrostatic Discharge (ESD)	+/- 20 kV air +/- 10 kV contact +/- 10 kV indirect discharge

## 5-Slot Charge ShareCradle with 4-Slot Battery Charger Technical Specifications

**Table 34** 5-Slot Charge ShareCradle with 4-Slot Battery Charger Technical Specifications

Item	Description
Dimensions	Height: 123.9 mm (4.88 in) Width: 489.0 mm (19.25 in) Depth: 142.8 mm (5.622 in)
Weight	2194 g (77.39 oz)
Input Voltage	12 VDC
Power Consumption	67 watts
Operating Temperature	0°C to 40°C (32°F to 104°F)
Storage Temperature	-40°C to 70°C (-40°F to 158°F)
Charging Temperature	0°C to 40°C (32°F to 104°F)
Humidity	10% to 95% non-condensing
Drop	75 cm (30 in.) to concrete; 2 drops/side for a total of 12 drops at room temperature (23°C).
Electrostatic Discharge (ESD)	+/- 20 kV air +/- 10 kV contact +/- 10 kV indirect discharge

## 5-Slot Ethernet ShareCradle with 4-Slot Battery Charger Technical Specifications

**Table 35** 5-Slot Ethernet ShareCradle with 4-Slot Battery Charger Technical Specifications

Item	Description
Dimensions	Height: 123.9 mm (4.88 in) Width: 489.0 mm (19.25 in) Depth: 142.8 mm (5.622 in)
Weight	2229 g (78.82 oz)
Input Voltage	12 VDC
Power Consumption	69 watts
Operating Temperature	0°C to 40°C (32°F to 104°F)
Storage Temperature	-40°C to 70°C (-40°F to 158°F)
Charging Temperature	0°C to 40°C (32°F to 104°F)
Humidity	10% to 95% non-condensing
Drop	75 cm (30 in.) to concrete; 2 drops/side for a total of 12 drops at room temperature (23°C).
Electrostatic Discharge (ESD)	+/- 20 kV air +/- 10 kV contact +/- 10 kV indirect discharge

## 4-Slot Spare Battery Charger Technical Specifications

**Table 36** 4-Slot Spare Battery Charger Technical Specifications

Item	Description
Dimensions	Height: 97.17 mm (3.82 in) Width: 97.55 mm (3.84 in) Depth: 143.0 mm (5.63 in)
Weight	510 g (17.98 oz)
Input Voltage	12 VDC
Power Consumption	30 watts
Operating Temperature	0°C to 40°C (32°F to 104°F)
Storage Temperature	-40°C to 70°C (-40°F to 158°F)
Charging Temperature	0°C to 40°C (32°F to 104°F)
Humidity	10% to 95% non-condensing
Drop	75 cm (30 in.) to concrete; 2 drops/side for a total of 12 drops at room temperature (23°C).
Electrostatic Discharge (ESD)	+/- 20 kV air +/- 10 kV contact +/- 10 kV indirect discharge

## 20-Slot Spare Battery Charger Technical Specifications

**Table 37** 20-Slot Spare Battery Charger Technical Specifications

Item	Description
Dimensions	Height: 105.2 mm (4.14 in) Width: 489.0 mm (19.25 in) Depth: 142.8 mm (5.62 in)
Weight	2820 g (92.42 oz)
Input Voltage	12 VDC
Power Consumption	99 watts
Operating Temperature	0°C to 40°C (32°F to 104°F)
Storage Temperature	-40°C to 70°C (-40°F to 158°F)
Charging Temperature	0°C to 40°C (32°F to 104°F)
Humidity	10% to 95% non-condensing
Drop	75 cm (30 in.) to concrete; 2 drops/side for a total of 12 drops at room temperature (23°C).
Electrostatic Discharge (ESD)	+/- 20 kV air +/- 10 kV contact +/- 10 kV indirect discharge

## USB Charge Cable Technical Specifications

**Table 38** USB Charge Cable Technical Specifications

Item	Description
Dimensions	Height: 32.6 mm (1.28 in) Width: 68.2 mm (2.68 in) Depth: 1690.0 mm (66.53 in)
Weight	120 g (4.23 oz)
Input Voltage	5 VDC
Power Consumption	N/A
Operating Temperature	0°C to 50°C (32°F to 104°F)
Storage Temperature	-40°C to 70°C (-40°F to 158°F)
Charging Temperature	0°C to 40°C (32°F to 104°F)
Humidity	10% to 95% non-condensing
Drop	75 cm (30 in.) to concrete; 2 drops/side for a total of 12 drops at room temperature (23°C).
Electrostatic Discharge (ESD)	+/- 20 kV air +/- 10 kV contact +/- 10 kV indirect discharge

