

# DS5502

Fixed Mount Scanner



**ZEBRA**

## **Product Reference Guide**

2024/07/17

ZEBRA and the stylized Zebra head are trademarks of Zebra Technologies Corporation, registered in many jurisdictions worldwide. All other trademarks are the property of their respective owners. ©2024 Zebra Technologies Corporation and/or its affiliates. All rights reserved.

Information in this document is subject to change without notice. The software described in this document is furnished under a license agreement or nondisclosure agreement. The software may be used or copied only in accordance with the terms of those agreements.

For further information regarding legal and proprietary statements, please go to:

SOFTWARE: [zebra.com/informationpolicy](https://zebra.com/informationpolicy).

COPYRIGHTS: [zebra.com/copyright](https://zebra.com/copyright).

PATENTS: [ip.zebra.com](https://ip.zebra.com).

WARRANTY: [zebra.com/warranty](https://zebra.com/warranty).

END USER LICENSE AGREEMENT: [zebra.com/eula](https://zebra.com/eula).

## Terms of Use

### Proprietary Statement

This manual contains proprietary information of Zebra Technologies Corporation and its subsidiaries ("Zebra Technologies"). It is intended solely for the information and use of parties operating and maintaining the equipment described herein. Such proprietary information may not be used, reproduced, or disclosed to any other parties for any other purpose without the express, written permission of Zebra Technologies.

### Product Improvements

Continuous improvement of products is a policy of Zebra Technologies. All specifications and designs are subject to change without notice.

### Liability Disclaimer

Zebra Technologies takes steps to ensure that its published Engineering specifications and manuals are correct; however, errors do occur. Zebra Technologies reserves the right to correct any such errors and disclaims liability resulting therefrom.

### Limitation of Liability

In no event shall Zebra Technologies or anyone else involved in the creation, production, or delivery of the accompanying product (including hardware and software) be liable for any damages whatsoever (including, without limitation, consequential damages including loss of business profits, business interruption, or loss of business information) arising out of the use of, the results of use of, or inability to use such product, even if Zebra Technologies has been advised of the possibility of such damages. Some jurisdictions do not allow the exclusion or limitation of incidental or consequential damages, so the above limitation or exclusion may not apply to you.

# Contents

<b>About this Guide.....</b>	<b>20</b>
Configurations.....	20
Notational Conventions.....	20
Icon Conventions.....	21
Service Information.....	21
<b>Getting Started.....</b>	<b>22</b>
Features.....	22
Removing the Protective Film.....	23
Connecting the Cable.....	24
Removing the Cable.....	24
Theory of Operation.....	27
<b>Using the Device.....</b>	<b>28</b>
Unpacking the Scanner.....	28
Holding the Device.....	28
Using the Gooseneck Stand.....	29
Mounting the Gooseneck Stand.....	31
Using the 3-in-1 Multi-Mount.....	31
Removing the Wide Base.....	32
Presentation Stand.....	33
Mounted Presentation Stand.....	35
Wall Mount.....	37
Monitor Mount.....	40
Tightening the Pivot Joints.....	43

Device Compatibility with the Legacy Mount.....	44
Third-Party Mounting Accessories.....	44
Location and Positioning.....	44
Embedded Applications Requiring a Window.....	45
Window Material.....	45
Commercially Available Coatings.....	45
Embedded Window Angle and Position.....	47
Recommended Exit Window Information.....	47
Accessories.....	48
Simple Serial Interface Software Developer's Kit (SSI SDK).....	49
Zebra SNAPI Software Developer's Kit.....	49
<b>123Scan and Software Tools.....</b>	<b>50</b>
123Scan.....	50
Communication with 123Scan.....	51
123Scan Requirements.....	51
123Scan Information.....	51
Scanner SDK, Other Software Tools, and Videos.....	52
Advanced Data Formatting.....	52
Multicode Data Formatting.....	53
Multicode Data Formatting Use.....	53
MDF for Best Practices.....	54
Preferred Symbol.....	55
Data Parsing (UDI Scan+, Label Parse+ and Blood Bag Parse+).....	55
Scan a UDI Label using UDI Scan+.....	56
Scan a GS1 Label using Label Parse+.....	56
Scan a Blood Bag Label using Blood Bag Parse+.....	56
<b>Data Capture.....</b>	<b>57</b>
Aiming the Device.....	57
Presentation Mode Scanning.....	58
Trigger Mode Scanning.....	58
Illumination System.....	59

Illumination Control.....	59
Scanner Indications.....	59
Supported Symbologies.....	62
Operating Modes.....	64
<b>Maintenance and Troubleshooting.....</b>	<b>65</b>
Maintaining the Device.....	65
Known Harmful Ingredients.....	65
Approved Cleaners for the Scanner.....	65
Cleaning the Scanner.....	66
Cleaning the Connector.....	66
Troubleshooting.....	66
<b>Specifications.....</b>	<b>68</b>
DS5502 Technical Specifications.....	68
Decode Ranges.....	70
<b>SSI Interface.....</b>	<b>72</b>
Communication.....	72
SSI Commands.....	72
SSI Transactions.....	73
General Data Transactions.....	73
Decoded Data Transmission.....	74
Communication Summary.....	75
RTS/CTS Lines.....	75
ACK/NAK Option.....	76
Number of Data Bits.....	76
Serial Response Timeout.....	76
Retries.....	76
Baud Rate, Stop Bits, Parity, Response Timeout, ACK/NAK Handshaking.....	76
Errors.....	76
SSI Communication Notes.....	76
Using Time Delay to Low Power Mode with SSI.....	77

Encapsulation of RSM Commands/Responses over SSI.....	77
Command Structure.....	77
Response Structure.....	78
Example Transaction.....	78
Setting SSI Parameters.....	79
SSI Scanning Sequence Examples.....	80
SSI Errors While Scanning.....	80
Simple Serial Interface Parameter Defaults.....	80
SSI Host Parameters.....	81
Select SSI Host.....	81
SSI Baud Rate.....	81
SSI Parity.....	82
Check Parity.....	83
SSI Stop Bits.....	83
Intercharacter Delay.....	83
Software Handshaking.....	84
Host RTS Line State.....	85
Decode Data Packet Format.....	85
Host Serial Response Timeout (SSI).....	85
Host Character Timeout.....	86
Multipacket Option.....	87
Interpacket Delay.....	87
Event Reporting.....	88
Decode Event.....	88
Boot Up Event.....	89
Parameter Event.....	89
<b>USB Interface.....</b>	<b>90</b>
USB Interface Connection.....	90
Connecting a USB Interface.....	91
USB Parameter Defaults.....	91
USB Host Parameters.....	92
USB Device Type.....	92
Symbol Native API (SNAPI) Status Handshaking.....	94

USB Keystroke Delay.....	94
USB Caps Lock Override.....	95
USB Barcodes with Unknown Characters.....	95
USB Convert Unknown to Code 39.....	96
USB Fast HID.....	96
USB Polling Interval.....	97
Keypad Emulation.....	99
USB Quick Keypad Emulation.....	99
Keypad Emulation with Leading Zero.....	99
USB Keyboard FN1 Substitution.....	100
USB Function Key Mapping.....	100
USB Simulated Caps Lock.....	101
USB Convert Case.....	101
USB Static CDC.....	102
CDC Beep on <BEL>.....	102
USB CDC Host Variant.....	103
TGCS (IBM) USB Beep Directive.....	103
TGCS (IBM) Ignore Type Directive.....	104
TGCS (IBM) USB Specification Version.....	104
USB ASCII Character Sets.....	105
<b>RS-232 Interface.....</b>	<b>106</b>
Connecting an RS-232 Interface.....	107
Serial Interface Cable Connection.....	108
RS-232 Parameter Defaults.....	108
RS-232 Host-Specific Parameter Settings.....	109
RS-232 Host-Specific Code ID Characters.....	110
RS-232 Host Types.....	112
RS-232 Baud Rate.....	113
RS-232 Parity.....	114
RS-232 Stop Bits.....	115
Data Bits.....	115
Check Receive Errors.....	115
Hardware Handshaking.....	116

Software Handshaking.....	117
RS-232 Host Serial Response Timeout.....	118
RTS Line State.....	119
Beep on <BEL>.....	119
Intercharacter Delay.....	120
Nixdorf Beep/LED Options.....	120
RS-232 Barcodes with Unknown Characters.....	121
Datalogic Host Format.....	121
Datalogic Supported Commands.....	121
NCR Host Preferences.....	122
RS-232 ASCII Character Sets.....	125

**User Preferences and Miscellaneous Options..... 126**

Setting User Preference Parameters.....	126
User Preference Scanning Sequence Examples.....	126
User Preference Errors While Scanning.....	126
User Preferences/Miscellaneous Options Parameter Defaults.....	126
User Preferences.....	128
Default Parameters.....	128
Parameter Barcode Scanning.....	129
Lock/Unlock Parameter Scanning.....	129
Beep After Good Decode.....	130
Beeper Volume.....	131
Scan Tone.....	131
Beeper Duration.....	132
Suppress Power Up Beeps.....	133
LED on Good Decode.....	133
Low Power Mode.....	133
Time Delay to Low Power Mode.....	134
Trigger Mode.....	135
Hand-held Decode Aiming Pattern.....	136
Hands-free (Presentation) Decode Aiming Pattern.....	136
Momentary Trigger Mode Timeout.....	137
Picklist Mode.....	137



Continuous Barcode Read.....	138
Unique Barcode Reporting.....	139
Decode Session Timeout.....	139
Hands-Free Decode Session Timeout.....	139
Timeout Between Decodes, Same Symbol.....	140
Timeout Between Decodes, Different Symbols.....	140
Mobile Phone/Display Mode.....	141
Motion Detect Mode (Wakeup).....	141
PDF Prioritization.....	142
PDF Prioritization Timeout.....	142
Presentation Mode Field of View.....	143
Mirrored Image.....	143
Decoding Illumination.....	144
Illumination Brightness.....	144
Low Light Scene Detection.....	144
Product ID (PID) Type.....	145
Product ID (PID) Value.....	145
Alternate Numeric Keypad Emulation.....	146
Miscellaneous Scanner Parameters.....	146
Enter Key.....	146
Tab Key.....	147
Transmit Code ID Character.....	147
Prefix Suffix Values.....	147
Scan Data Transmission Format.....	148
FN1 Substitution Values.....	149
Report Software Version.....	150
Transmit No Read Message.....	150
Unsolicited Heartbeat Interval.....	151
<b>Driver's License Set Up.....</b>	<b>152</b>
Driver's License Parsing.....	152
Parsing Driver's License Data Fields (Embedded Driver's License Parsing).....	153
Embedded Driver's License Parsing Criteria - Code Type.....	153
Driver's License Parse Rules.....	153

Driver's License Parse Fields.....	154
AAMVA Parse Fields.....	155
Parser Version ID Barcode.....	162
DL Parsing User Preferences.....	162
Set Default Parameter.....	162
Output Gender as M or F.....	163
Date Format.....	163
Send Keystroke (Control Characters and Keyboard Characters).....	164
Parsing Rule Example.....	178
Embedded Driver's License Parsing ADF Example.....	180
<b>Image Capture Preferences.....</b>	<b>183</b>
Setting Image Capture Parameters.....	183
Image Capture Scanning Sequence Examples.....	183
Image Capture Errors While Scanning.....	183
Image Capture Preferences Default Parameters.....	184
Image Capture Preferences Modes and Parameters.....	185
Operational Modes.....	185
Image Capture Illumination.....	186
Image Capture Autoexposure.....	186
Fixed Exposure.....	187
Gain/Exposure Priority for Snapshot Mode.....	187
Snapshot Mode Timeout.....	188
Snapshot Aiming Pattern.....	188
Silence Operational Mode Changes.....	189
Image Cropping.....	189
Crop to Pixel Addresses.....	190
Image Size (Number of Pixels).....	190
Image Brightness (Target White).....	191
JPEG Image Options.....	192
JPEG Quality Value.....	192
JPEG Size Value.....	192
Image Enhancement.....	193
Image File Format Selector.....	193

Image Rotation.....	194
Bits Per Pixel.....	194
Signature Capture.....	195
Signature Capture File Format Selector.....	196
Signature Capture Bits Per Pixel.....	196
Signature Capture Width.....	197
Signature Capture Height.....	197
Signature Capture JPEG Quality.....	198
Video View Finder.....	198
Video View Finder Image Size.....	198
<b>Signature Capture Code.....</b>	<b>199</b>
Code Structure.....	199
Signature Capture Area.....	199
CapCode Pattern Structure.....	199
Start / Stop Patterns.....	200
Dimensions.....	201
Data Format.....	201
Additional Capabilities.....	201
Signature Boxes.....	202
<b>Symbologies.....</b>	<b>203</b>
Symbologies.....	203
Enable/Disable All Code Types.....	208
UPC/EAN/JAN.....	208
UPC-A.....	209
UPC-E.....	209
UPC-E1.....	209
EAN-8/JAN-8.....	210
EAN-13/JAN-13.....	210
Bookland EAN.....	211
Bookland ISBN Format.....	211
ISSN EAN.....	211

Decode UPC/EAN/JAN Supplementals.....	212
User-Programmable Supplementals.....	214
UPC/EAN/JAN Supplemental Redundancy.....	215
UPC/EAN/JAN Supplemental AIM ID Format.....	215
Transmit UPC-A Check Digit.....	216
Transmit UPC-E Check Digit.....	216
Transmit UPC-E1 Check Digit.....	217
UPC-A Preamble.....	217
UPC-E Preamble.....	218
UPC-E1 Preamble.....	218
Convert UPC-E to UPC-A.....	219
Convert UPC-E1 to UPC-A.....	219
EAN/JAN Zero Extend.....	220
UCC Coupon Extended Code.....	220
Coupon Report.....	221
UPC Reduced Quiet Zone.....	221
Code 128.....	222
Set Lengths for Code 128.....	222
GS1-128 (formerly UCC/EAN-128).....	223
ISBT 128.....	223
ISBT Concatenation.....	224
Check ISBT Table.....	225
ISBT Concatenation Redundancy.....	225
Ignore Code 128 <FNC4>.....	225
Code 128 Security Level.....	226
Code 128 Reduced Quiet Zone.....	227
Code 39.....	227
Trioptic Code 39.....	228
Convert Code 39 to Code 32.....	228
Code 32 Prefix.....	228
Set Lengths for Code 39.....	229
Code 39 Check Digit Verification.....	230
Transmit Code 39 Check Digit.....	230
Code 39 Full ASCII Conversion.....	231

Code 39 Security Level.....	231
Code 39 Reduced Quiet Zone.....	232
Code 93.....	233
Set Lengths for Code 93.....	233
Code 11.....	234
Set Lengths for Code 11.....	234
Code 11 Check Digit Verification.....	235
Transmit Code 11 Check Digits.....	236
Interleaved 2 of 5 (I 2 of 5).....	236
Set Lengths for Interleaved 2 of 5 (I 2 of 5).....	237
Interleaved 2 of 5 (I 2 of 5) Check Digit Verification.....	238
Transmit I 2 of 5 Check Digit.....	238
Convert Interleaved 2 of 5 (I 2 of 5) to EAN-13.....	239
Interleaved 2 of 5 (I 2 of 5) Security Level.....	239
Interleaved 2 of 5 (I 2 of 5) Reduced Quiet Zone.....	240
Discrete 2 of 5 (D 2 of 5).....	241
Set Lengths for Discrete 2 of 5 (D 2 of 5).....	241
Codabar (NW - 7).....	242
Set Lengths for Codabar.....	242
CLSI Editing.....	243
NOTIS Editing.....	244
Codabar Security Level.....	244
Codabar Upper or Lower Case Start/Stop Characters.....	245
Codabar Mod 16 Check Digit Verification.....	246
Transmit Codabar Check Digit.....	246
MSI.....	246
Set Lengths for MSI.....	247
MSI Check Digits.....	248
Transmit MSI Check Digit(s).....	248
MSI Check Digit Algorithm.....	249
Chinese 2 of 5.....	249
Matrix 2 of 5.....	250
Set Lengths for Matrix 2 of 5.....	250
Matrix 2 of 5 Check Digit.....	251

Transmit Matrix 2 of 5 Check Digit.....	251
Korean 3 of 5.....	252
Inverse 1D.....	252
GS1 DataBar.....	253
GS1 DataBar Omnidirectional (formerly GS1 DataBar-14).....	253
GS1 DataBar Limited.....	253
GS1 DataBar Expanded.....	254
Convert GS1 DataBar to UPC/EAN/JAN.....	254
GS1 DataBar Limited Margin Check.....	255
GS1 DataBar Security Level.....	255
Symbology-Specific Security Features.....	256
Redundancy Level.....	256
Security Level.....	257
1D Quiet Zone Level.....	258
Intercharacter Gap Size.....	259
Composite.....	259
Composite CC-C.....	259
Composite CC-A/B.....	260
Composite TLC-39.....	260
Composite Inverse.....	261
UPC Composite Mode.....	261
Composite Beep Mode.....	262
GS1-128 Emulation Mode for UCC/EAN Composite Codes.....	262
2D Symbologies.....	263
PDF417.....	263
MicroPDF417.....	263
Code 128 Emulation.....	263
Data Matrix.....	264
GS1 Data Matrix.....	265
Data Matrix Inverse.....	265
Maxicode.....	265
QR Code.....	266
GS1 QR.....	266
MicroQR.....	267

Linked QR Mode.....	267
Aztec.....	268
Aztec Inverse.....	268
Han Xin.....	268
Han Xin Inverse.....	269
Grid Matrix.....	269
Grid Matrix Inverse.....	270
Grid Matrix Mirrored.....	270
DotCode.....	271
DotCode Inverse.....	271
DotCode Mirrored.....	272
DotCode Prioritize.....	272
DotCode Erasure Limit.....	273
Postal Codes.....	273
US Postnet.....	273
US Planet.....	273
Transmit US Postal Check Digit.....	274
UK Postal.....	274
Transmit UK Postal Check Digit.....	274
Japan Postal.....	275
Australia Post.....	275
Australia Post Format.....	275
Netherlands KIX Code.....	276
USPS 4CB/One Code/Intelligent Mail.....	277
UPU FICS Postal.....	277
Mailmark.....	277
Macro PDF Features.....	278
Flush Macro PDF Buffer.....	278
<b>Intelligent Document Capture (Hand-Held Mode Only).....</b>	<b>279</b>
The Intelligent Document Capture (IDC) Process.....	279
Barcode Acceptance Test.....	279
Capture Region Determination.....	280
Image Post Processing.....	281

Data Transmission.....	281
PC Application and Programming Support.....	281
Image Document Capture Parameter Defaults.....	281
IDC Operating Mode.....	282
IDC Symbology.....	283
IDC X Coordinate.....	284
IDC Y Coordinate.....	284
IDC Width.....	284
IDC Height.....	285
IDC Aspect.....	285
IDC File Format Selector.....	285
IDC Bits Per Pixel.....	286
IDC JPEG Quality.....	286
IDC Find Box Outline.....	286
IDC Minimum Text Length.....	287
IDC Maximum Text Length.....	287
IDC Captured Image Brighten.....	288
IDC Captured Image Sharpen.....	288
IDC Border Type.....	288
IDC Delay Time.....	289
IDC Zoom Limit.....	289
IDC Maximum Rotation.....	290
Quick Start.....	290
Sample IDC Setup.....	290
IDC Demonstrations.....	291
Other Suggestions.....	292
Quick Start Form.....	293
<b>OCR Programming.....</b>	<b>294</b>
OCR Parameter Defaults.....	294
OCR Programming Parameters.....	295
OCR-A.....	295
OCR-A Variant.....	295
OCR-B.....	297



OCR-B Variant.....	297
MICR E13B.....	300
US Currency Serial Number.....	301
OCR Orientation.....	301
OCR Lines.....	302
OCR Minimum Characters.....	303
OCR Maximum Characters.....	303
OCR Subset.....	303
OCR Quiet Zone.....	304
OCR Bright Illumination.....	304
OCR Template.....	305
OCR Check Digit Modulus.....	313
OCR Check Digit Multiplier.....	313
OCR Check Digit Validation.....	314
Inverse OCR.....	318
OCR Redundancy.....	319
<b>Numeric Barcodes.....</b>	<b>321</b>
Cancel.....	322
<b>Alphanumeric Barcodes.....</b>	<b>323</b>
Cancel.....	323
Alphanumeric Barcodes.....	323
<b>ASCII Character Sets.....</b>	<b>334</b>
<b>Programming Reference.....</b>	<b>342</b>
Symbol Code Identifiers.....	342
AIM Code Identifiers.....	343
<b>Standard Parameter Defaults.....</b>	<b>348</b>

<b>Country Codes.....</b>	<b>359</b>
USB and Keyboard Wedge Country Keyboard Types (Country Codes).....	359
Country Code Barcodes.....	359
<b>Country Code Pages.....</b>	<b>371</b>
Country Code Page Defaults.....	371
Country Code Page Barcodes.....	374
<b>CJK Decode Control.....</b>	<b>380</b>
CJK Control Parameters.....	380
Unicode Output Control.....	380
CJK Output Method to Windows Host.....	380
Non-CJK UTF Barcode Output.....	382
Unicode/CJK Decode Setup with Windows Host.....	383
Setting Up the Windows Registry Table for Unicode Universal Output.....	383
Adding CJK IME on Windows.....	384
Selecting the Simplified Chinese Input Method on the Host.....	384
Selecting the Traditional Chinese Input Method on the Host.....	385
<b>Non-Parameter Attributes.....</b>	<b>387</b>
Model Number.....	387
Serial Number.....	387
Date of Manufacture.....	387
Date of First Programming.....	388
Configuration Filename.....	388
Beeper/LED.....	388
Parameter Defaults.....	389
Beep on Next Bootup.....	389
Reboot.....	390
Host Trigger Session.....	390
Firmware Version.....	390
Scankit Version.....	390

<b>Sample Barcodes.....</b>	<b>391</b>
Sample Code 39.....	391
Sample Code 93.....	391
Sample UPC/EAN.....	391
Sample Code 128.....	393
Sample Interleaved 2 of 5.....	393
Sample Chinese 2 of 5.....	393
Sample Matrix 2 of 5.....	394
Sample Korean 3 of 5.....	394
Sample GS1 DataBar.....	394
Sample PDF417.....	395
Sample Data Matrix.....	395
Sample Maxicode.....	395
Sample QR Code.....	395
Sample Aztec.....	396
Sample Grid Matrix.....	396
Postal Codes.....	396
Sample US Postnet.....	396
Sample UK Postal.....	396

# About this Guide

This document provides general instructions for mounting, setting up, and programming the DS5502 fixed mount scanner.

## Configurations

The DS5502 offers the following configurations.

**Table 1** DS5502 Fixed Mount Scanner Configurations

Configuration	Description
DS5502-SR40004ZZWW	Digital Scanner, Standard Range, Midnight Black (White Illum, Green LED Aimer)
DS5502-SR40004ZZCN	Digital Scanner, Standard Range, Midnight Black (White Illum, Green LED Aimer), China Only
DS5502-DL40004ZZNA	Digital Scanner, Standard Range, Driver's License Parsing, Midnight Black (White Illum, Green LED Aimer), NA only
DS5502-LB4000WZZWW	Digital Scanner, Standard Range, Labs, White (White Illum, Green LED Aimer)
DS5502-LL4000WZZNA	Digital Scanner, Standard Range, Labs, Driver's License Parsing, White (Nova White) (White Illum, Green LED Aimer), NA only

## Notational Conventions

The following notational conventions make the content of this document easy to navigate.

- **Bold** text is used to highlight the following:
  - Dialog box, window, and screen names
  - Dropdown list and list box names
  - Checkbox and radio button names
  - Icons on a screen
  - Key names on a keypad
  - Button names on a screen

- Bullets (•) indicate:
  - Action items
  - List of alternatives
  - Lists of required steps that are not necessarily sequential.
- Sequential lists (for example, those that describe step-by-step procedures) appear as numbered lists.

## Icon Conventions

The documentation set is designed to give the reader more visual clues. The following visual indicators are used throughout the documentation set.



**NOTE:** The text here indicates information that is supplemental for the user to know and that is not required to complete a task.



**IMPORTANT:** The text here indicates information that is important for the user to know.



**CAUTION:** If the precaution is not heeded, the user could receive a minor or moderate injury.



**WARNING:** If danger is not avoided, the user CAN be seriously injured or killed.



**DANGER:** If danger is not avoided, the user WILL be seriously injured or killed.

## Service Information

If you have a problem using the equipment, contact your facility's technical or systems support. If there is a problem with the equipment, they will contact the Zebra Global Customer Support Center at: [zebra.com/support](http://zebra.com/support).

When contacting Zebra support, have the following information available:

- Serial number of the unit.
- Model number or product name.
- Software type and version number.

Zebra responds to calls by email, telephone, or fax within the time limits set forth in service agreements.

If your problem cannot be solved by Zebra support, you may need to return your equipment for servicing and will be given specific directions. Zebra is not responsible for any damages incurred during shipment if the approved shipping container is not used. Shipping the units improperly can possibly void the warranty.

If you purchased your business product from a Zebra business partner, please contact that business partner for support.

# Getting Started

The DS5502 fixed mount scanner is specifically designed for standalone applications and OEM applications. The scanner is compact, provides easy and flexible integration of barcode scanning into a host device, and offers high-performance scanning on 1D and 2D barcodes. The DS5502 is ideal for various uses: kiosks, embedded medical diagnostic equipment, conveyor lines in manufacturing environments, and more. The DS5502 can also be used as a zero-footprint 2D array scanning solution in retail point of sale (POS) environments.

## Features

The DS5502 is equipped with a variety of features such as:

- Compact, and easy to install and integrate.
- Reliable scanning performance on all 1D and 2D barcodes.
- USB or RS232 (serial) interface.
- Top-mounted LEDs indicating successful decodes and power status.
- Easy programming and configuration.
- Flexible mounting options.

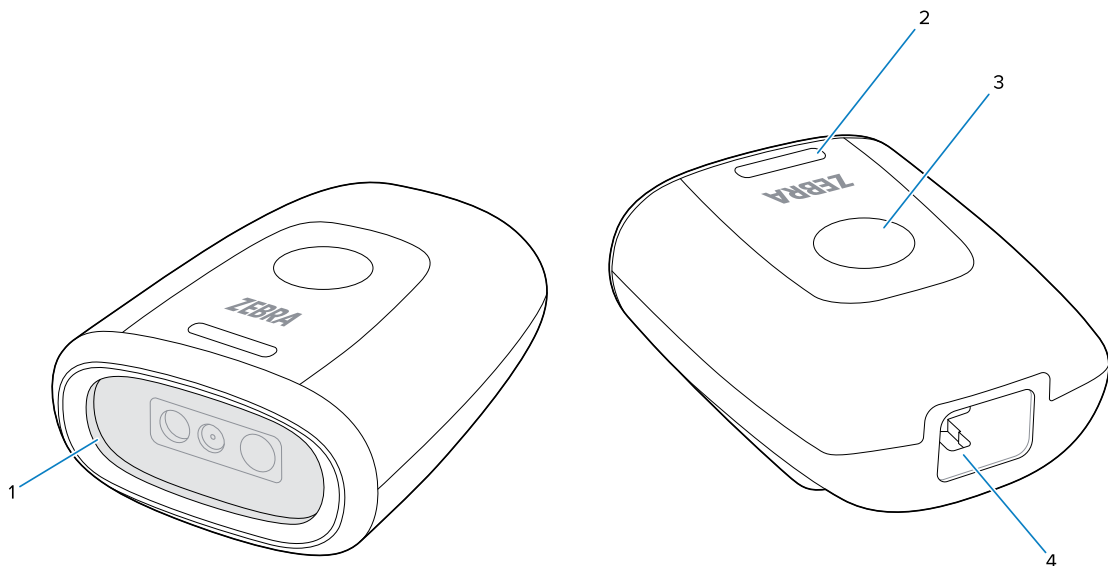

1	Scanner Window
2	LED Indicator
3	Trigger Button
4	Interface Cable Port

This guide includes programming parameters and describes the theory of operation, installation, specification, and configuration.

## Removing the Protective Film

Remove the protective film from the device before use.

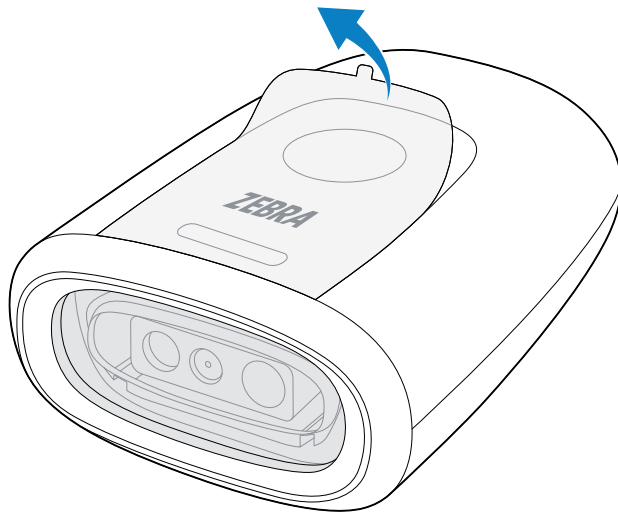

## Connecting the Cable

This section describes installing the cable into the scanner.

1. With the latch facing down, plug in the cable until the latch clicks.

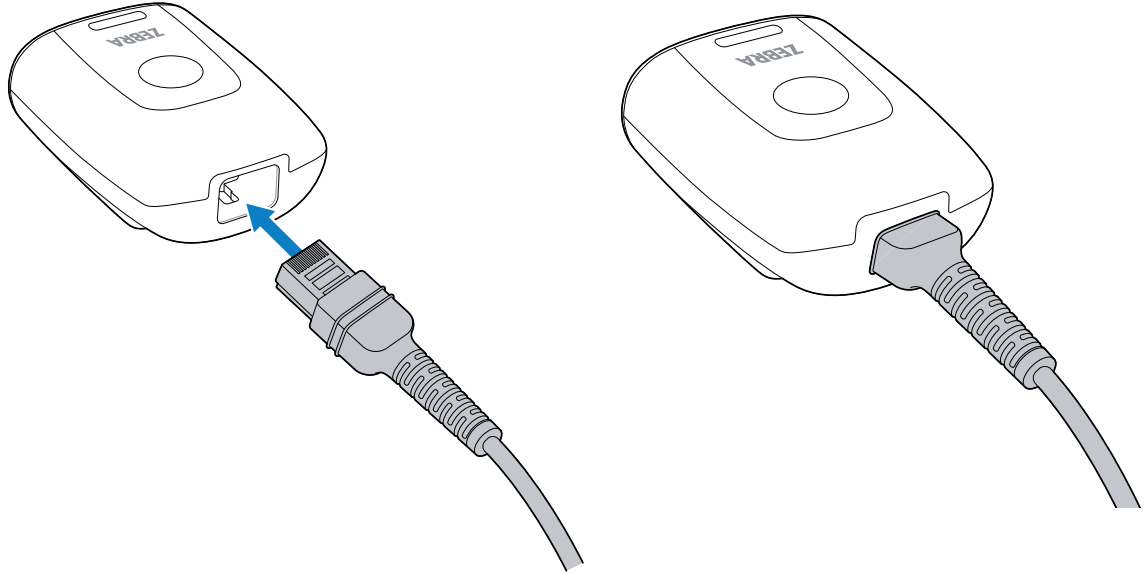

2. Connect the other end of the cable to either the USB or RS-232 port on your host computer. For more information, go to [USB Interface Connection](#) on page 90 or [Connecting an RS-232 Interface](#) on page 107.

## Removing the Cable

This section describes how to remove the cable from the device.

1. Lay the device on its back on a flat surface. To avoid any damage, place a soft material underneath.

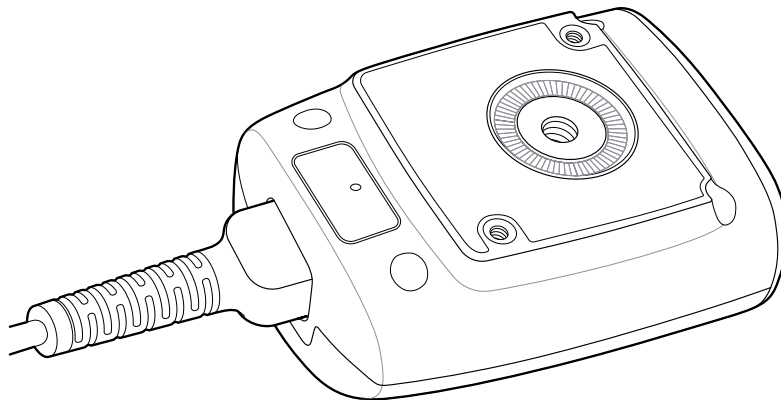



2. Grasp the strain relief section of the cable with your fingers pressed against the device.

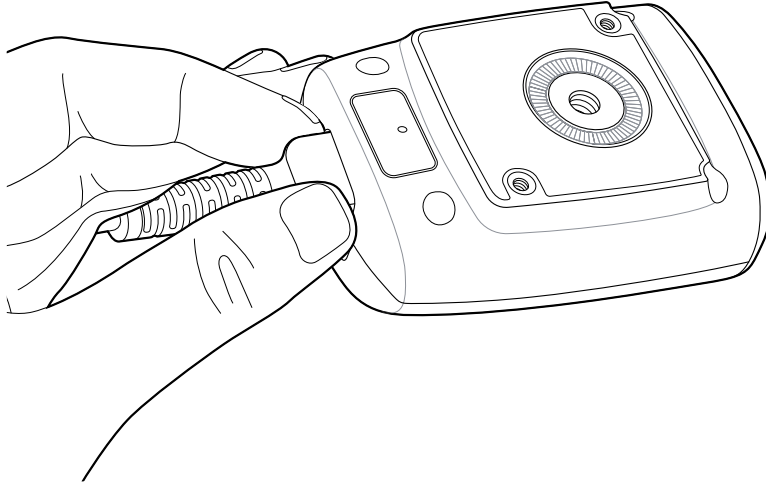

3. With your other hand, insert a paper clip into the pinhole to push down the cable latch.

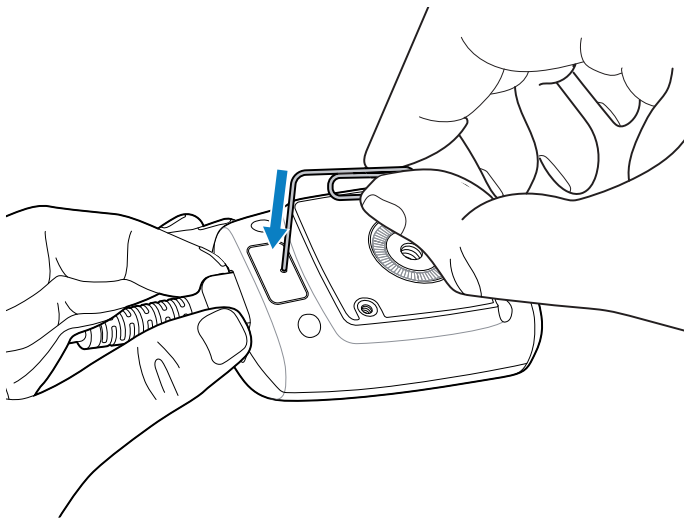

4. Gently pull the cable out a slight amount.

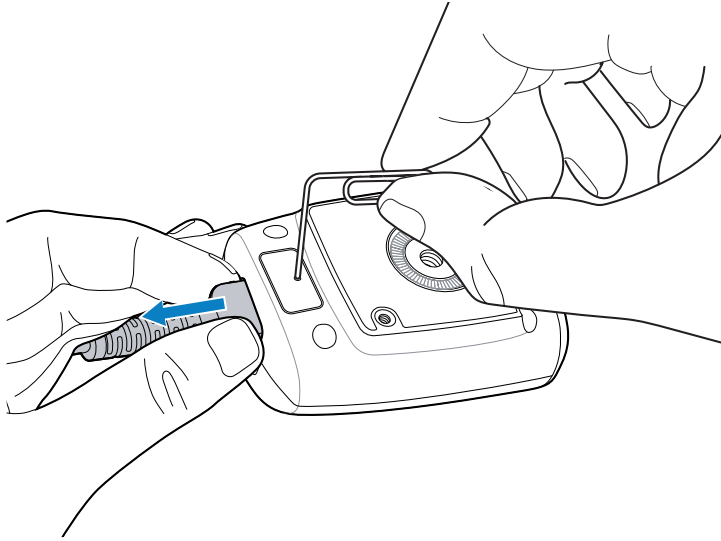

5. Withdraw the paper clip.

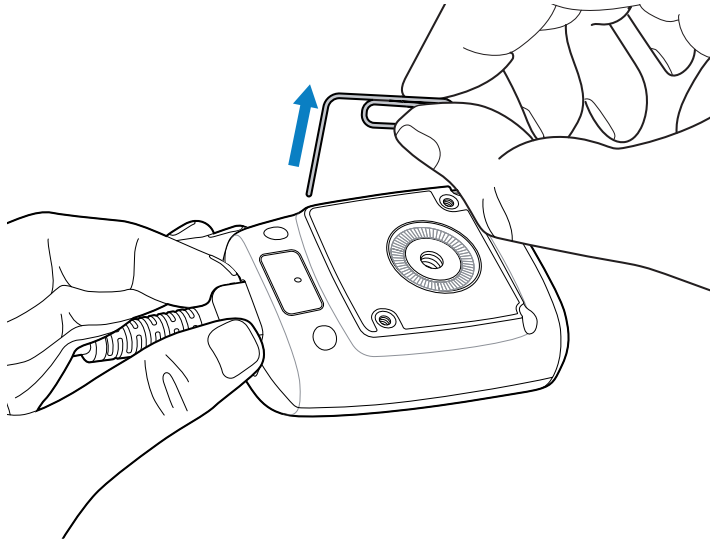

6. Fully remove the cable.

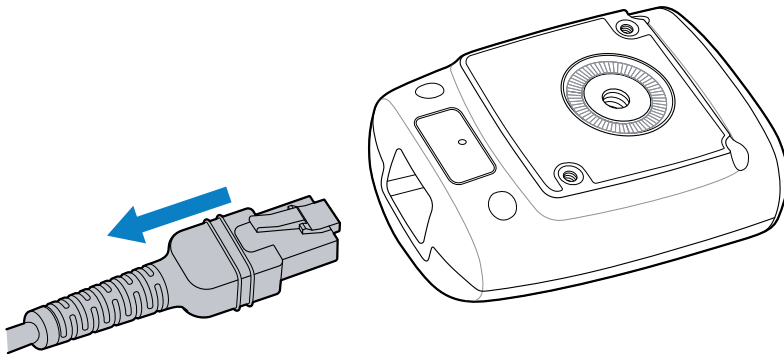

## Theory of Operation

During the image capture:

1. The embedded scan engine's image sensor array captures an image of the barcode through the engine's optical lens. If necessary, the engine automatically adjusts illumination, exposure, and other parameters to obtain the best-quality image.
2. The image engine sends the image to the device's CPU.
3. The device's CPU processes the image to identify the target barcode(s), decodes them, and then transmits the decoded data to the host.

Set various parameters provided in this guide to adjust the performance of the device to match the application or desired usage profile.

# Using the Device

This chapter provides information on unpacking, mounting, and using the scanner.

## Unpacking the Scanner

Remove the scanner from its packing and inspect it for damage. The following items are included in the package:

- Scanner.
- Regulatory Guide.



**NOTE:** Go to [Service Information](#) on page 21 for contact information. **KEEP THE PACKAGING.** It is the approved shipping container and should be used if it is ever necessary to return the equipment for servicing.

## Holding the Device

The device can be used hand-held. Ensure you have a firm grip to prevent it from slipping or falling.

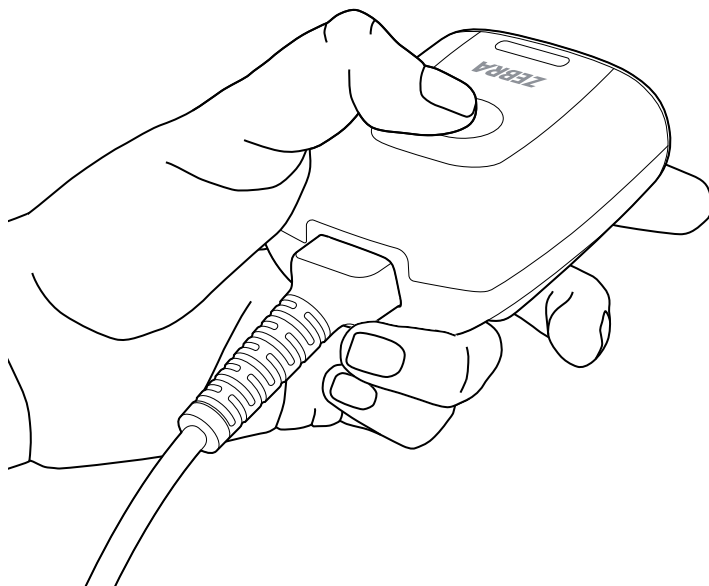



**NOTE:** Use either the straight cable or the 90-degree cable when the device is hand-held.

## Using the Gooseneck Stand

Use the optional gooseneck stand to mount the scanner.

1. Unscrew the wingnut located at the bottom of the gooseneck.

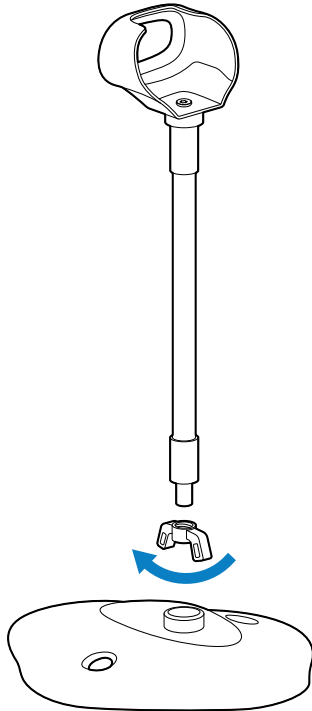

2. Insert the threaded end of the gooseneck into the base.

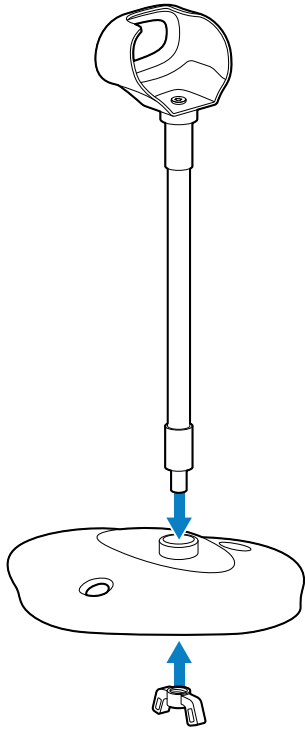

3. From the underside of the base, fasten the gooseneck by screwing and tightening the wingnut into it.

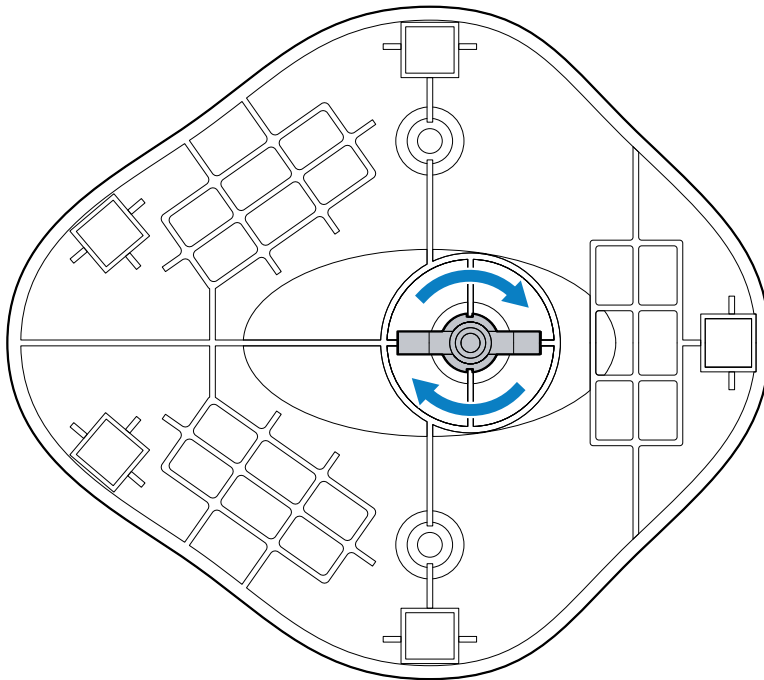

4. Attach the power cable to the scanner, and then insert the scanner into the cup of the gooseneck stand.

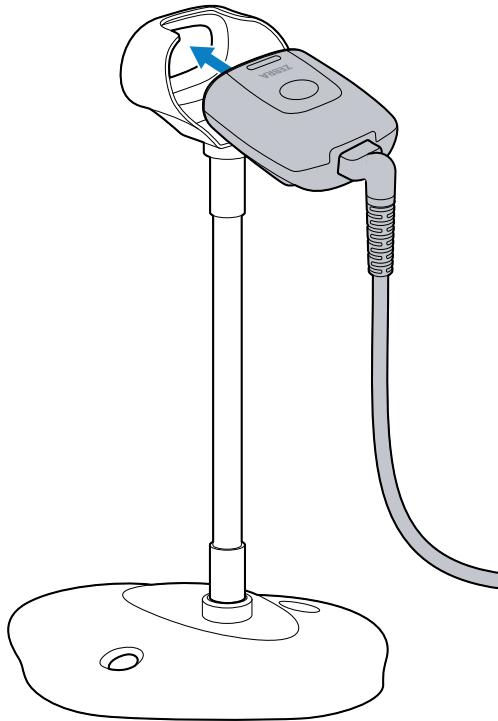

**NOTE:** Use the 90-degree cable when the device is table-top mounted.

### Mounting the Gooseneck Stand

You can attach the base of the stand to a flat surface using two screws.

1. Position the assembled base on a flat surface.
2. Screw in a #10 wood screw (not provided) into each screw-mount hole until the base of the stand is secure.

### Using the 3-in-1 Multi-Mount

Use the optional 3-in-1 multi-mount to mount the scanner to a tabletop, monitor, or wall (or other vertical surface). The mount can also function independently as a presentation stand.



**NOTE:**

Mount the scanner no more than 2 m (6 ft 5 in.) above the floor.

## Removing the Wide Base

The following describes how to remove the wide base from the 3-in-1 multi-mount.

1. Using a Philips-head screwdriver, fully unscrew the screw located at the rear of the wide base, making sure it is not attached to the narrow base.

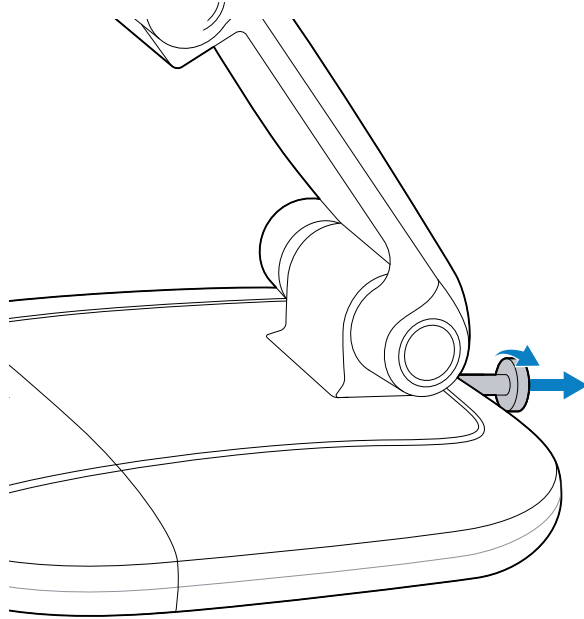

2. With one hand, grasp the main arm and then use your other hand to hold down the wide base.



3. Pivot the narrow base away from the wide base notch (1), and then lift it out.

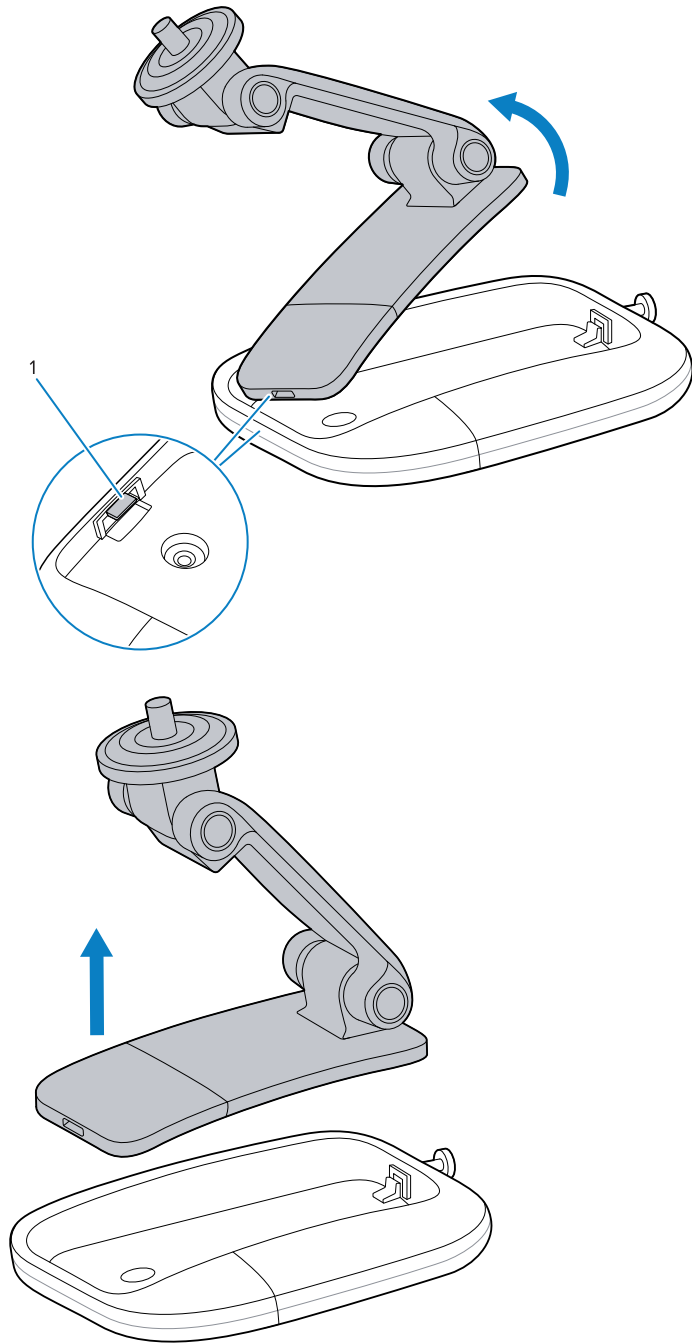

### Presentation Stand

To use the 3-in-1 multi-mount as a presentation stand:

1. Attach the cable to the scanner. For more information, go to [Connecting the Cable](#) on page 24.



**NOTE:** Use the 90-degree cable when the device is mounted onto a presentation stand.

2. Adjust the pivot joints to the desired position.

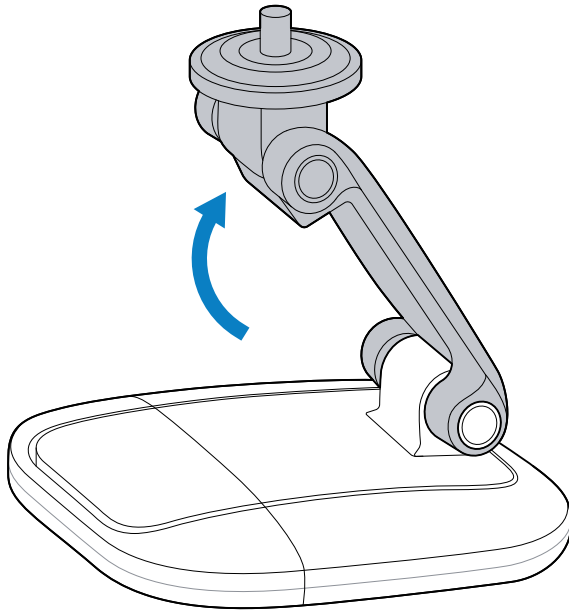

3. Mount the scanner onto the top swivel plate, and then orient the scanner window to face down as needed.

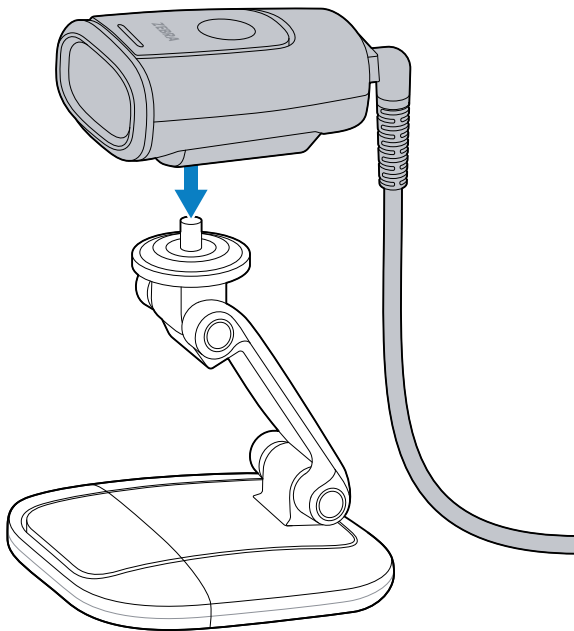

The device is held in place by the magnetic swivel plate.

The presentation stand can also function without the use of the wide base. For more information, go to [Removing the Wide Base](#) on page 32.

## Mounted Presentation Stand

You can mount the presentation stand to a tabletop.

1. Attach the cable to the scanner.



**NOTE:** Use the 90-degree cable when the device is tabletop-mounted.

2. Remove the wide base from the 3-in-1 multi-mount. For more information, go to [Removing the Wide Base](#) on page 32.
3. Position the wide base on a flat tabletop surface.
4. Insert a #6 wood screw (not provided) through each screw hole, and then tighten the screws to secure the wide base to the tabletop.

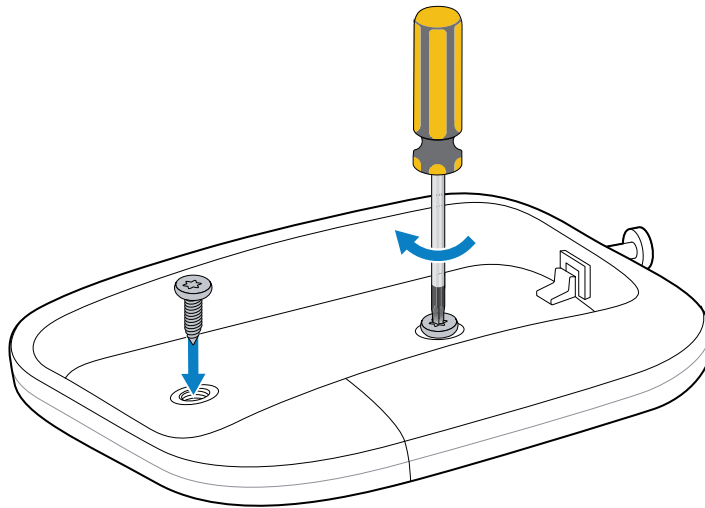

5. Pivot and slot (1) the narrow base into the notch (2) of the wide base, and then fully lower the narrow base into the wide base.

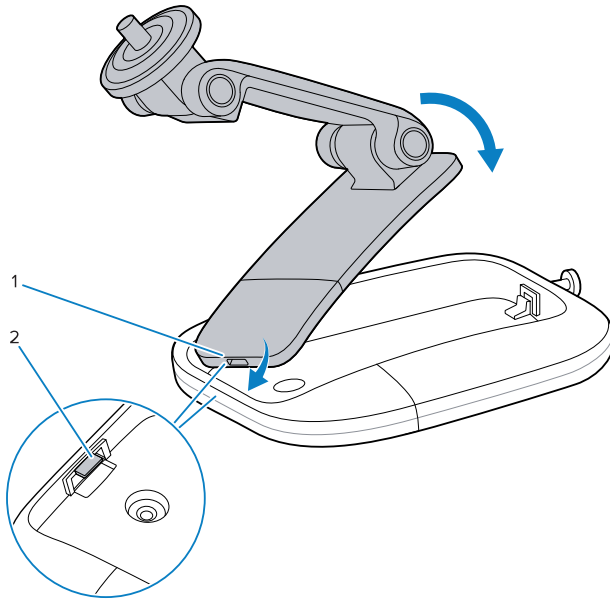

6. Using a Philips-head screwdriver, tighten the wide base screw to fasten the narrow base to the wide base.

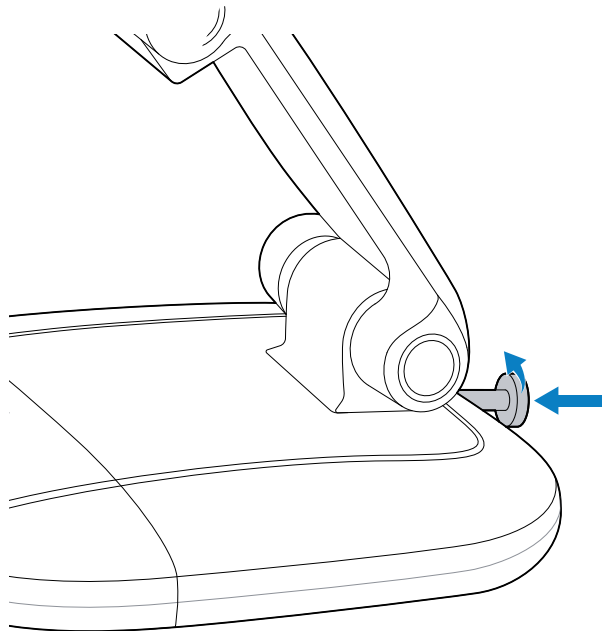

7. Mount the scanner onto the top swivel plate.

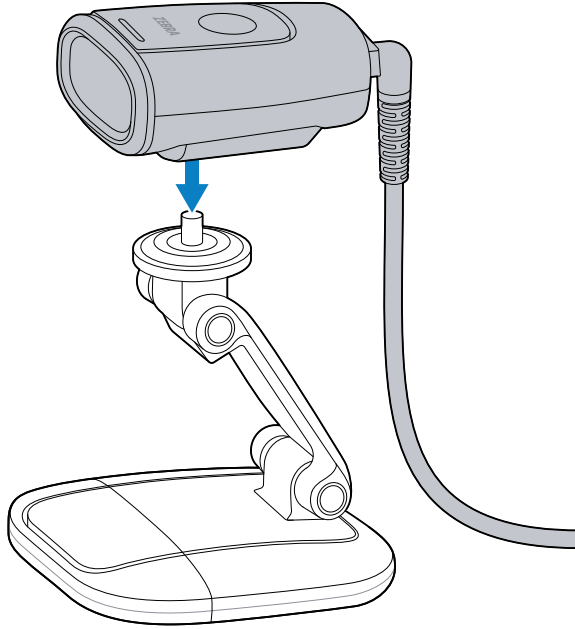

### Wall Mount

The 3-in-1 wide base can serve as a wall mount, enabling the device to be mounted to a wall.

1. Remove the wide base from the 3-in-1 multi-mount. For more information, go to [Removing the Wide Base](#) on page 32.
2. Mark the location on the wall where the wide base will be installed.



**NOTE:** Mount the scanner no more than 2 m (6 ft 5 in.) above the floor.

3. Install the cable into the wide base.



**NOTE:** Use the straight cable when the device is wall-mounted.

- a) Position the cable connector through the top D-Cutout (1) located next to the wide base screw.
- b) Run the cable downward along the edge of the wide base and out the D-Cutout (2) on the opposite end.

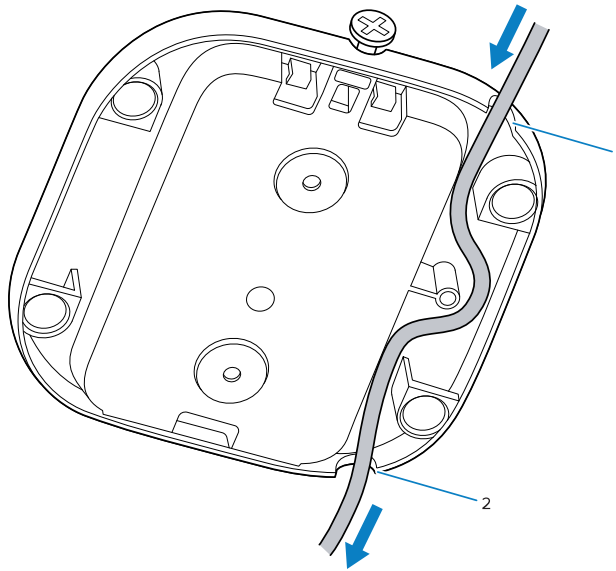

4. With the cable installed, hold the wide base to the predetermined location on the wall, and then insert and tighten #6 wood screws (not provided) through each screw hole in the wide base.

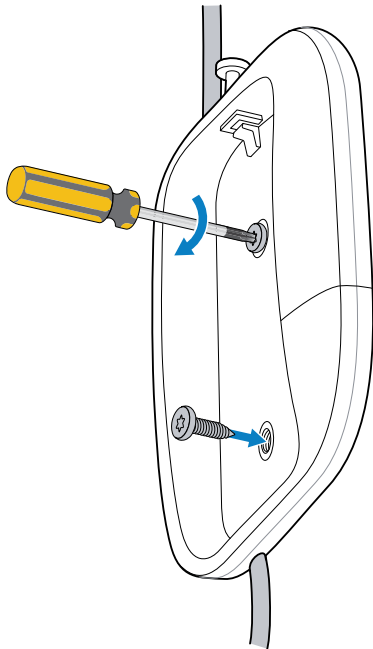

5. Pivot and slot (1) the narrow base into the (2) notch of the wide base, and then fully insert the narrow base into the wide base.

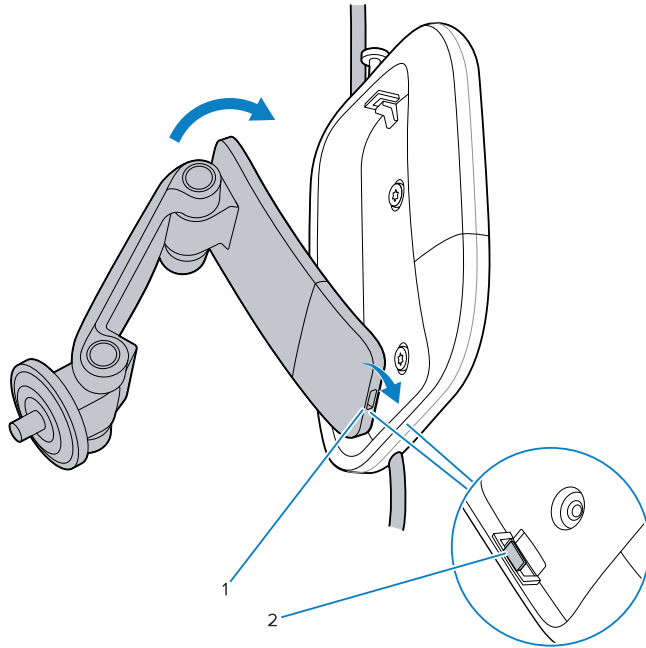

6. Using a Philips-head screwdriver, tighten the wide base screw to fasten the narrow base to the wide base.

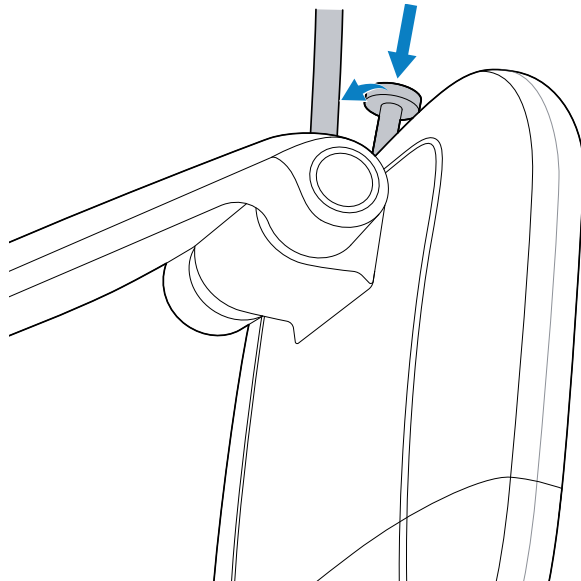

7. Connect the power cable to the scanner, and then mount the scanner onto the top swivel plate.

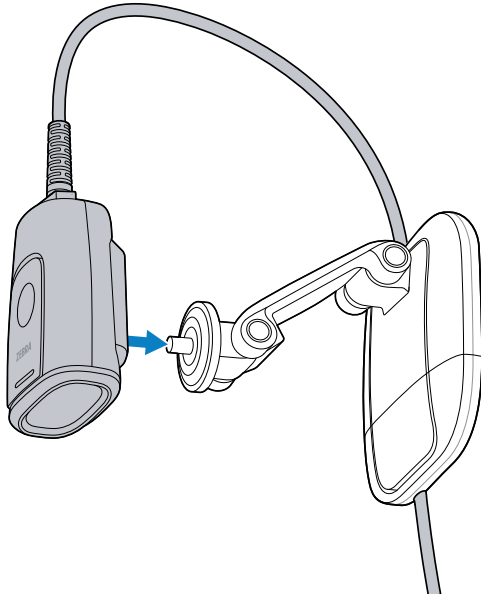

8. Orient the scanner window to face down as needed.

### Monitor Mount

This section describes how to mount the 3-in-1 multi-mount to a monitor.

1. Attach the cable to the scanner. For more information, go to [Connecting the Cable](#) on page 24.



**NOTE:** Use the 90-degree cable when the device is monitor-mounted.

2. Remove the wide base from the 3-in-1 multi-mount. For more information, go to [Removing the Wide Base](#) on page 32.



3. Widen the main arm and set it atop the monitor, with the hook oriented toward the front and the base toward the back.

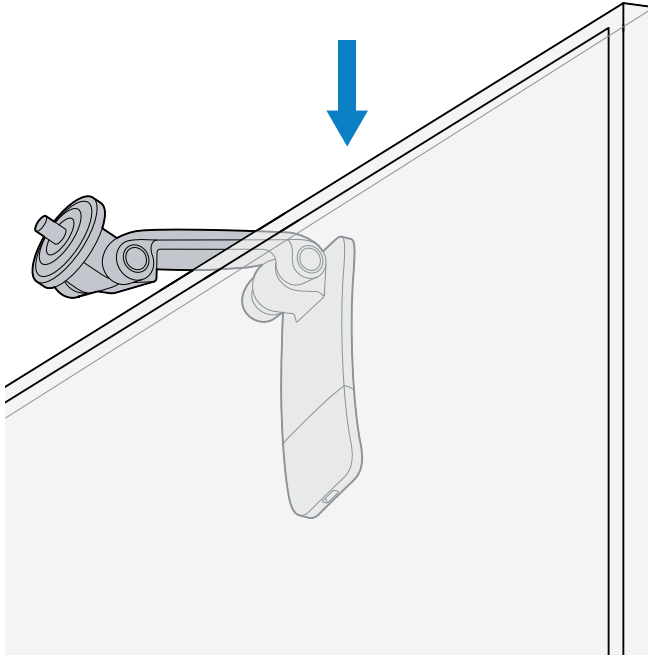

- a) Optionally, you can first apply the Zebra-provided adhesive tape to the inside of the arm or on the top of the monitor to enhance grip.

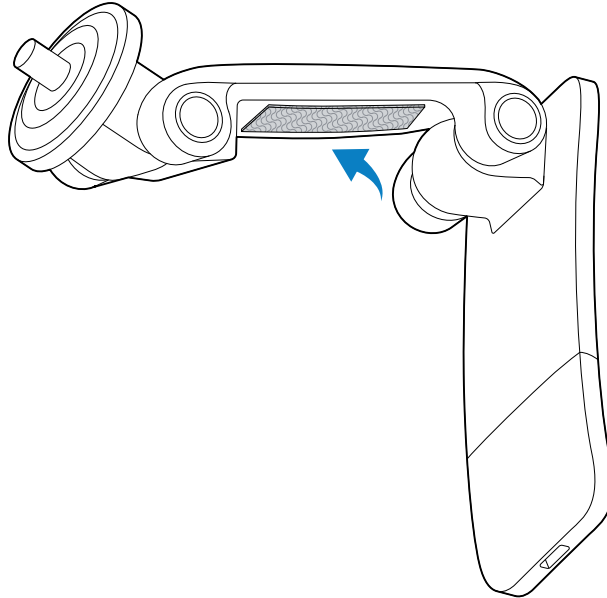

4. Gently close the main arm until it firmly grips the monitor.

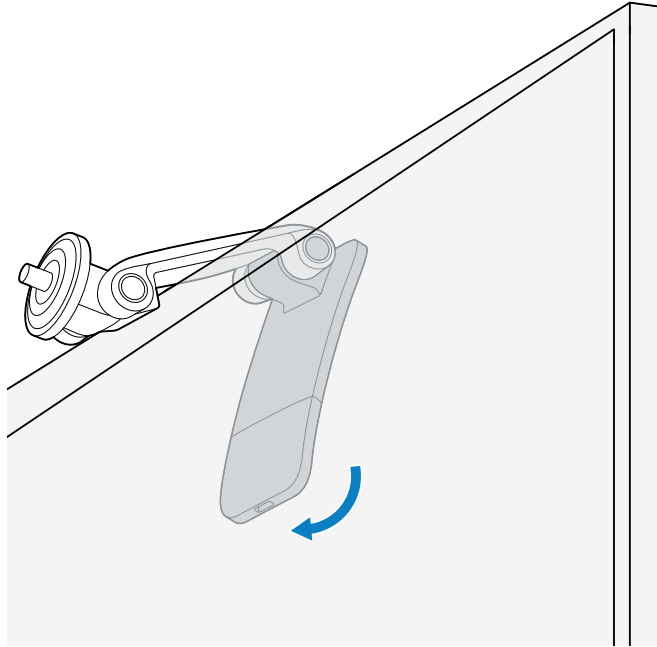

5. Mount the scanner onto the top swivel plate, and then orient the scanner window to face down as needed.

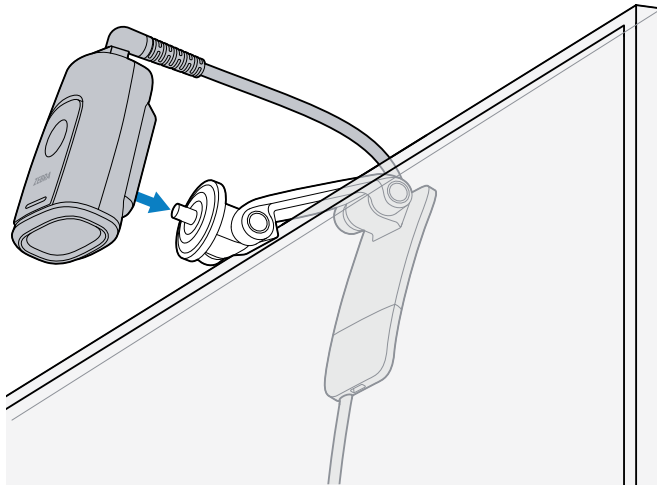

**NOTE:** Adhesive cable clamps (not provided) are recommended for cable management.

## Tightening the Pivot Joints

The 3-in-1 multi-mount pivot joints can be tightened again if necessary.

1. From the orientation shown, remove the rubber plug from the pivot joint that needs tightening.

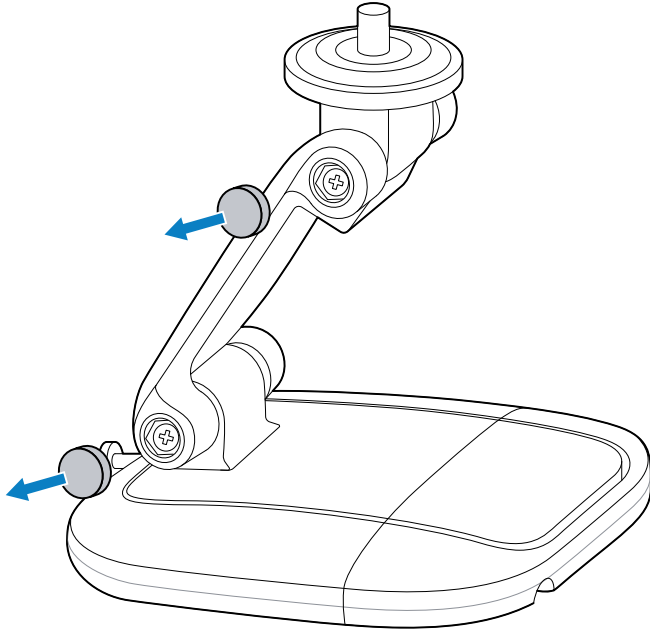

2. Using a Philips-head screwdriver, adjust the tightness of the pivot joint as needed, and then reinsert the rubber plug into the pivot joint.

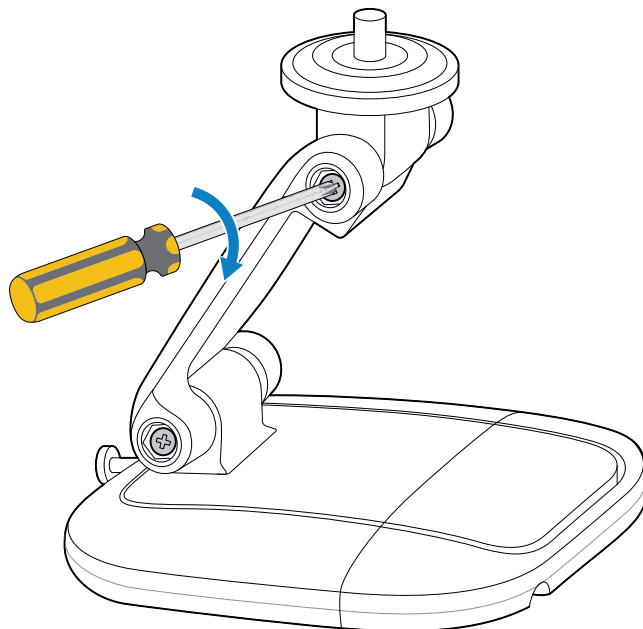

## Device Compatibility with the Legacy Mount

The DS5502's mounting pattern is fully compatible with the DS457 mount and can be secured using two M3 screws (not provided).

**Figure 1** DS457 Legacy Mount

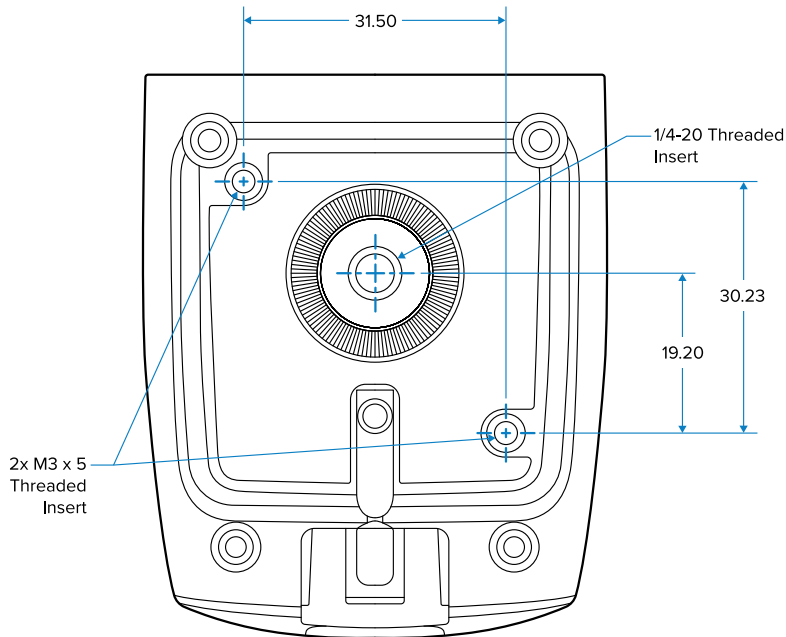

## Third-Party Mounting Accessories

The scanner is compatible with third-party accessories equipped with a standard 1/4-inch threaded screw bolt (1/4-20 UNC), such as a tripod. Consult the user guide of your third-party device.

## Location and Positioning

The location and positioning guidelines do not consider unique application characteristics. Zebra recommends that an opto-mechanical engineer perform an opto-mechanical analysis before integration.



**NOTE:** Follow these suggestions to ensure product longevity, warranty, and overall satisfaction with the scanner:

- Integrate the scanner in an environment no more extreme than the product's specification, where it will not exceed its temperature range. For instance, do not mount the scanner onto or next to a large heat source.
- When placing the scanner with another device, ensure there is proper convection or venting for heat.

## Embedded Applications Requiring a Window

Use the following guidelines for applications that require a window in front of the device.



**NOTE:** Zebra does not recommend placing an exit window in front of the device. However, the following information is provided for applications that require such a window.

### Window Material

Many window materials that look perfectly clear can contain stresses and distortions that can reduce scanner performance. For this reason, use only cell-cast plastics or optical glass (with or without an anti-reflection coating, depending on the application). Following are descriptions of three popular window materials: PMMA, ADC (CR-39™), and chemically tempered glass. The following table outlines the suggested window properties.



**NOTE:** Consider the following window placement and material recommendations if mounting the device within a product with its own window.

**Table 2** Suggested Window Properties

Property	Description
Material	Clear cell-cast acrylic
Spectral Transmission	85% minimum at 400 - 700 nm
Thickness	1.4986 ± 0.127 mm (0.059 ± 0.005 in.)
Wavefront Distortion (transmission)	0.2 wavelengths peak-to-valley maximum over any 2.032 mm (0.08 in.) diameter within the clear aperture
Clear Aperture	To extend to within 1.016 mm (0.04 in.) of the edges all around
Surface Quality	60-20 scratch/dig



**CAUTION:** Consult an optomechanical engineer to recommend an appropriate window material and to determine if coatings are appropriate for the specific application.



**NOTE:** Do not use polycarbonate material.

### Commercially Available Coatings

Anti-reflection and Polysiloxane coatings are available on the commercial market.

#### Anti-Reflection Coating

Anti-reflection coatings can be used for stray light control or to achieve maximum working range, and can be applied to the inside and/or outside of the window to reduce the amount of light reflected off the

window back into the engine. However, they are expensive and have very poor abrasion and scratch resistance.

### Polysiloxane Coating

Polysiloxane type coatings are applied to plastic surfaces to improve the surface resistance to both scratch and abrasion. To apply, dip and air dry in an oven with filtered hot air.

To gauge a window's durability, use ASTM standard D1044, Standard Test Method for Resistance of Transparent Plastics to Surface Abrasion (the Taber Test), which quantifies abrasion resistance as a percent increase in haze after a specified number of cycles and load. Lower values of the increase in haze correspond to better abrasion and scratch resistance. See Table below.

**Table 3** Taber Test Results on Common Exit Window Materials

Sample	Haze 100 Cycles	Haze 500 Cycles	Abrasion Resistance
Chemically Tempered Glass	1.20%	1.50%	Best
PMMA with Polysiloxane Hardcoat	3%	10%	
ADC	5%	30%	
PMMA	30%		Worst

 **NOTE:** All measurements use a 100 g load and CS-10F abramer.

**Table 4** Window Manufacturers and Coaters

Company	Discipline	Specifics
<b>Evaporated Coatings, Inc.</b> 2365 Maryland Road Willow Grove, PA 19090 (215) 659-3080	Anti-reflection coater	Acrylic window supplier Anti-reflection coater
<b>Fosta-Tek Optics, Inc.</b> 320 Hamilton Street Leominster, MA 01453 (978) 534-6511	Cell-caster, hard coater, laser cutter	CR39 exit window manufacturer
<b>Optical Polymers Int. (OPI)</b> 110 West Main Street Milford, CT 06460 (203) 882-9093	CR-39 cell-caster, coater, laser cutter	CR-39 exit window manufacturer
<b>Polycast</b> 70 Carlisle Place Stamford, CT 06902 (800) 277-9778	Acrylic cell-caster, hard coater, laser cutter	Acrylic exit window manufacturer

**Table 4** Window Manufacturers and Coaters (Continued)

Company	Discipline	Specifics
<b>TSP</b> 2009 Glen Parkway Batavia, OH 45103	Acrylic cell-caster, coater, laser cutter	Acrylic exit window manufacturer

## Embedded Window Angle and Position

If you are placing a window between the device and the target, observe the following guidelines:

- **Window Clear Opening** - Make the clear opening of the window large enough so that the entire scanner's clear aperture passes through the window. Cutting off any part of the clear aperture can degrade decode range performance. Ensure that window placement relative to the DS5502 accounts for tolerances on all parts involved in that assembly.
- **Window Angle** - Minimum window tilt is indicated in [Recommended Exit Window Information](#) on page 47. Further tilting the window is acceptable and decreases the possibility of a secondary reflection from that window degrading the scanner's performance.
- **Minimum Window Distance** - 5 mm.
- **Optical Working Range** - Adding a window can reduce the working range of the scanner because there is a signal loss when passing through window material. To minimize this reduction, use a special coating described in [Commercially Available Coatings](#) on page 45. To understand the difference, test the scanner in the desired orientation and see if the difference affects the scanner's performance.

## Recommended Exit Window Information

**Figure 2** Window Distances

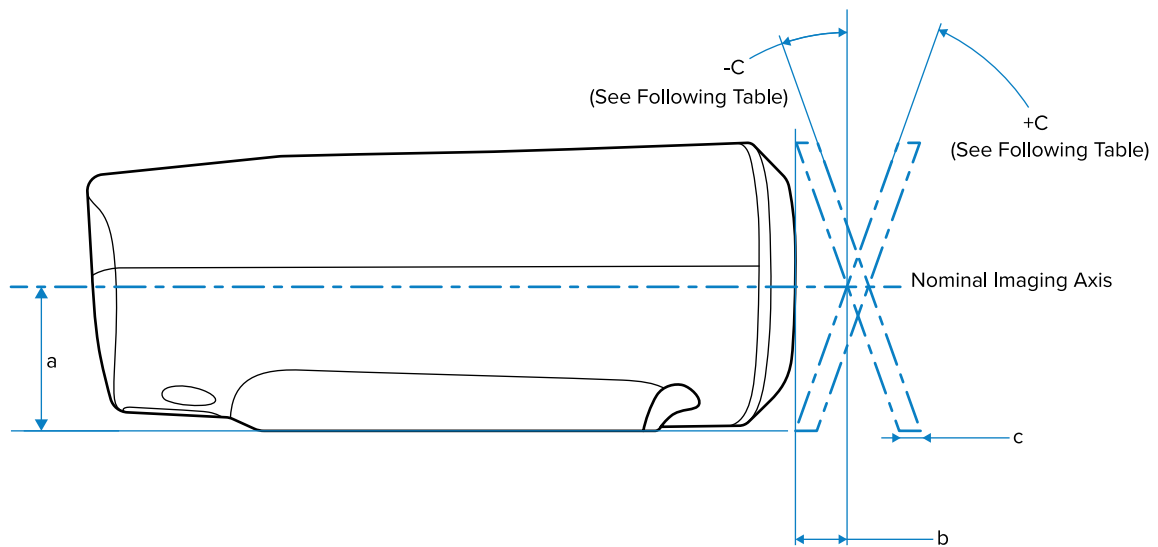

**NOTE:**

(a) Engine imaging axis = 15.4 mm (0.6 in.)

(b) Minimum external window distance = 5 mm (0.2 in.)

(c) Window thickness = 1.5 mm (0.06 in.)

**Table 5** Recommended Exit Window Information - Tilted Window

External Window Specification	Minimum Window Angle
Non-coated, minimum window positive tilt (+c)	31°
Non-coated, minimum window negative tilt (-c)	31°
AR coated, one side, minimum window positive tilt (+c)	26°
AR coated, one side, minimum window negative tilt (-c)	27°
AR coated, two sides, minimum window positive tilt (+c)	24°
AR coated, two sides, minimum window negative tilt (-c)	20°

#### Exit Window Notes

- Integration tolerances are not included.
- Ensure the window size is large enough to cover the engine clear aperture, plus the window's mounting tolerances relative to the engine.

## Accessories

Zebra offers the following accessories for the scanner.

**Table 6** DS5502 Scanner Accessories

Accessory	Part Number
Mounting Brackets	
3-in-1 Multi-Mount	BRKT-MM0055C-04
Flexible Gooseneck Presentation Stand featuring Scanner Cup Black	STND-GS0055C-04
Flexible Gooseneck Presentation Stand featuring Scanner Cup White	STND-GS0055C-0W
Cables	
USB Cable: 2 ft	CBL-U10255-01
USB Cable: 7 ft	CBL-U10755-01
USB Cable: 2 ft with connector angled at 90 degrees	CBL-U20255-01
USB Cable: 7 ft with Connector angled at 90 degrees	CBL-U20755-01
RS-232 Cable: 7 ft	CBL-R10755-01
RS-232 Cable: 7 ft with connector angled at 90 degrees	CBL-R20755-01
Power Supplies	
Power Supply, 5VDC, 100 - 240VAC, US/CA/MX/JP/TW	PWR-WUA5V4W0US
Power Supply, 5VDC, 100 - 240VAC, EU/UK	PWR-WUA5V4W0EU
Power Supply, 5VDC, 100 - 240VAC, CN	PWR-WUA5V4W0CN



## Simple Serial Interface Software Developer's Kit (SSI SDK)

The SSI Software Developer's Kit, available on Zebra's website, provides the software tools used to integrate and communicate with the DS5502 scanners via RS-232, including:

- Sample Windows program® with source code.
- DLL with source code for building user applications.
- ActiveX component (including help file) for easy integration into VisualBasic programs.
- Simple Serial Interface documentation.

With over 70 programmable parameters, you can configure the scanners using barcode menus, or through the serial interface using Zebra's Simple Serial Interface protocol.

For Windows®, DOS, and embedded system environments, this enables you to take full advantage of the scanner's features and obtain maximum performance.

To download the SDK, go to [zebra.com/support](http://zebra.com/support).

## Zebra SNAPI Software Developer's Kit

The Symbol Native Application Programming Interface Software Development Kit (SNAPI SDK) facilitates communication with SNAPI-based Zebra scanners over USB, providing the following features:

- Barcode capture and decode.
- Image and video capture.
- Electronic scanner configuration and software update.
- Reference sample application in Microsoft Visual C#® .NET.

To download the SDK, go to [zebra.com/support](http://zebra.com/support).

# 123Scan and Software Tools

This section describes the Zebra software tools available for customizing scanner operation.

## 123Scan

123Scan is a software tool that simplifies scanner setup and more.

Intuitive enough for first-time users, the 123Scan wizard guides users through a streamlined setup process. Settings are saved in a configuration file that can be printed as a single programming barcode for scanning, emailed to a smart phone for scanning from its screen or downloaded to the scanner using a USB cable.

Through 123Scan a user can:

- Configure a scanner using a wizard.
  - Program the following scanner settings.
    - Beeper tone/volume settings.
    - Enable/disable symbologies.
    - Communication settings.
  - Modify data before transmission to a host using:
    - Advanced Data Formatting (ADF) - Scan one barcode per trigger pull.
    - Multicode Data Formatting (MDF) - Scan many barcodes in one trigger pull (select scanners).
    - Preferred Symbol - Single out one barcode on a label of many (select scanners).
- Load parameter settings to a scanner via the following:
  - Barcode scanning.
    - Scan a paper barcode.
    - Scan a barcode from a PC screen.
    - Scan a barcode from a smart phone screen.
  - Download over a USB cable.
    - Load settings to one scanner.
    - Stage up to 10 scanners simultaneously (Powered USB Hub recommended with 0.5 amp / port).

- Validate scanner setup.
  - View scanned data within the utility's Data view screen.
  - Capture an image and save it to a PC within the utility's Data view screen.
  - Review settings using the Parameter Report.
  - Clone settings from an already deployed scanner from the Start screen.
- Upgrade scanner firmware.
  - Load settings to one scanner.
  - Stage up to 10 scanners simultaneously (Powered USB Hub recommended with 0.5 amp/port).
- View statistics, such as:
  - Asset tracking information.
  - Time and usage information.
  - Barcodes scanned by symbology.
- Generate the following reports.
  - Barcode Report - Programming barcode, relevant parameter settings, and supported scanner models.
  - Parameter Report - Parameters programmed within a configuration file.
  - Inventory Report - Scanner asset tracking information.
  - Validation Report - Scanned data from the Data view.
  - Statistics Report - All statistics retrieved from the scanner.

For more information, go to [zebra.com/123Scan](https://zebra.com/123Scan).

### Communication with 123Scan

Use a USB cable to connect the scanner to a Windows host computer running 123Scan.

### 123Scan Requirements

- Host computer running Windows 10 or 11
- Scanner
- USB cable

### 123Scan Information

Use these links to learn more about using 123Scan and Zebra software tools.

For more information on 123Scan, go to [zebra.com/123Scan](https://zebra.com/123Scan)

For a one-minute tour of 123Scan, go to [zebra.com/ScannerHowToVideos](https://zebra.com/ScannerHowToVideos)

To see a list of all of our software tools, go to [zebra.com/scannersoftware](https://zebra.com/scannersoftware)

## Scanner SDK, Other Software Tools, and Videos

Tackle all your scanner programming needs with our diversified set of software tools. Whether you need to stage a device or develop a fully featured application with image and data capture and asset management, these tools help you every step of the way.

To download any of the following free tools, go to: [zebra.com/scannersoftware](https://zebra.com/scannersoftware).

- 123Scan configuration utility
- SDKs
  - Scanner SDK for Windows
  - Scanner SDK for Linux
  - Scanner SDK for Android
  - Scanner SDK for iOS
- Drivers
  - OPOS driver
  - JPOS driver
  - USB CDC driver
- Scanner Management Service (SMS) for Remote Management
  - Windows
  - Linux
- Mobile Apps
  - Scanner Control App
    - Android
    - iOS
  - Scan-To-Connect Utility
    - Android
    - Windows
- How-To-Videos



**NOTE:** For a list of SDK-supported scanner functionality by communication protocol, see .

## Advanced Data Formatting

Advanced Data Formatting (ADF) allows customizing data before transmission to the host device. Use ADF to edit scanned data to suit the host application's requirements. With ADF you scan one barcode per trigger pull. ADF is programmed using 123Scan.

For a video on Creating an Advanced Data Formatting (ADF) Rule using 123Scan, go to [zebra.com/ScannerHowToVideos](https://zebra.com/ScannerHowToVideos).

For additional information, refer to the Advanced Data Formatting Programmer Guide.

## Multicode Data Formatting

Programming options include:

- Output all or specific barcodes.
- Control the barcode output sequence.
- Apply unique multicode data formatting (MDF) to each output barcode.
- Discard scanned data if all required barcodes are not present.

For more information, refer to the Multicode Data Formatting and Preferred Symbol User Guide, p/n MN-002895-xx.

For a video on Creating an Multicode Data Formatting (MDF) Rule using 123Scan, go to [zebra.com/ScannerHowToVideos](http://zebra.com/ScannerHowToVideos).

## Multicode Data Formatting Use

Multicode Data Formatting may yield multiple unexpected and undesired outputs when a label (most likely on a complex label) passes through the scanner's field of view. This problem happens when the complex label's barcodes can be matched by more than one group (for example, Group 1 represents all barcodes present, and Group 2 represent some barcodes present).

1. As the label is moving through the field of view, it is first partially read (some of the barcodes in the field of view in Frame 2).
2. Then, the second decode occurs as it is fully read (all the barcodes in the field of view in Frame 3).
3. This yields two different outputs (instead of the expected single output) from the presentation of a label. This problem is driven by a complex label inadvertently matching two different MDF rules/groups, thereby yielding two outputs.

**Figure 3** Scanning Label in a Horizontal Orientation

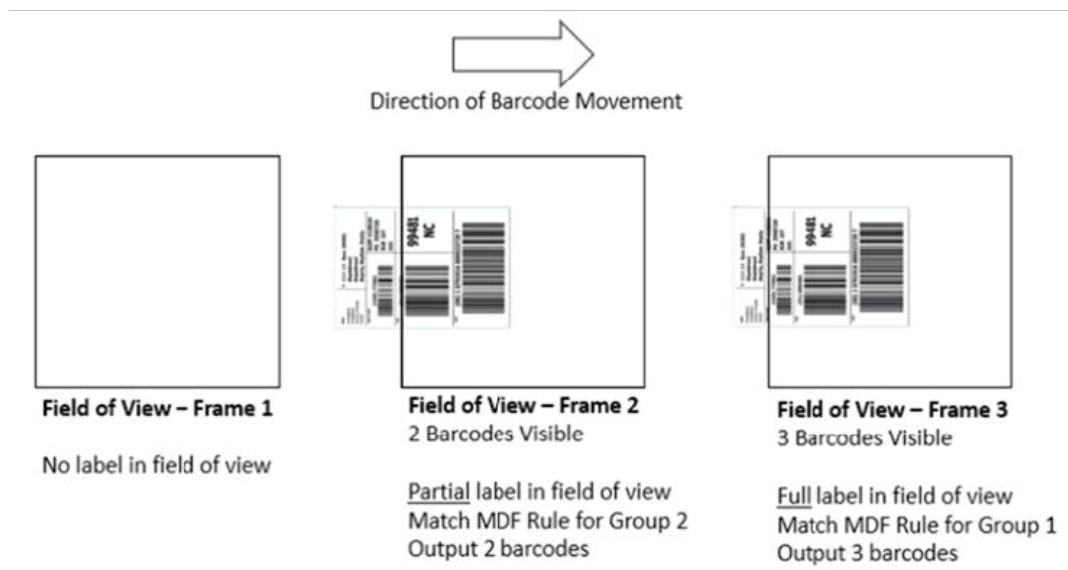

## MDF for Best Practices

Suggestions to minimize the undesired multiple outputs when scanning with MDF.

- Scan barcodes in a vertical orientation.

**Figure 4** Scanning Label in a Vertical Orientation

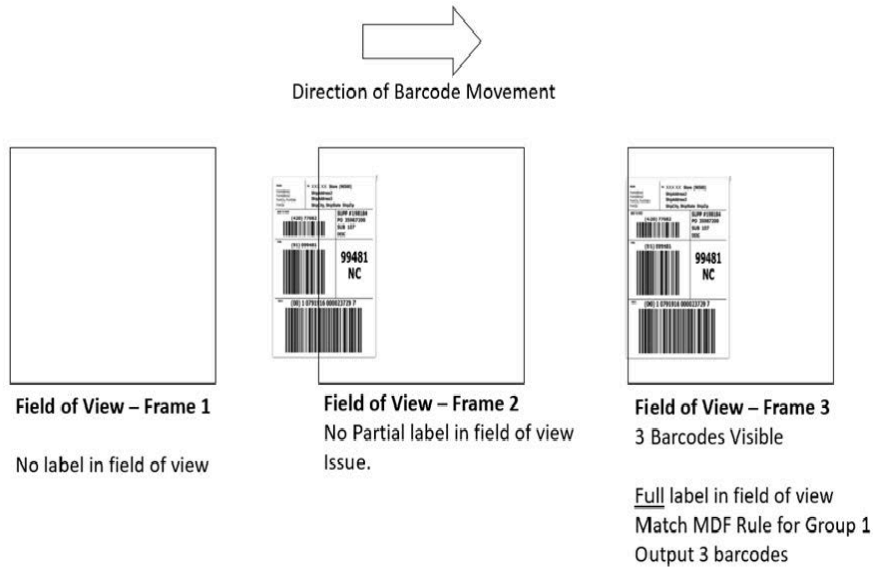

- When creating the MDF programming with multiple groups, the Group 1's pattern match should be the most complicated (hardest to match), which equals to the most number of barcodes and criteria. Then Group 2, 3, and so on should be progressively matched more easily.
- When defining criteria, avoid enabling an output when the pattern is not matched. Set **Output if NO pattern match** set as **Discard bar code**.

**Figure 5** Figure Match Setting for Output

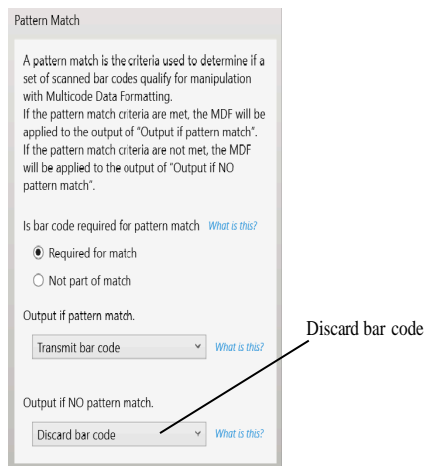

- Select **Discard barcode(s) NOT within the pattern match** in the 123Scan MDF setting. For more details, select **What is this?** located next to this selection.

- To prevent double decodes of the same symbol, increase the **Timeout Between Same Symbols** setting. See [Timeout Between Decodes, Same Symbol](#) on page 140 for more details.
- Turn the scanner's aimer on to assist operators in scanning the barcode in a more consistent manner.
- Other reasons a label/barcode may not be decoded while in the field of view are as follows:
  - The label out of focus (too close or too far away).
  - Specular reflection (reflection off a shiny surface).
  - The label is presented at an extreme angle to the scanner.

## Preferred Symbol

Preferred Symbol is a barcode prioritization technique that enables favored decoding of high-priority barcode(s). The Preferred Symbol is the only barcode that is decoded and output within the preset Preferred Symbol Timeout. During this time, the scanner attempts to decode the prioritized barcode and reports only this barcode.

For more information, refer to the Multicode Data Formatting and Preferred Symbol User Guide, p/n MN-002895-xx.

To program Preferred Symbol via 123Scan, select **123Scan > Configuration Wizard > Symbologies** screen, and then select **Preferred Symbol** from the drop-down menu. Preferred Symbol programming is saved in the 123Scan configuration file.

**Figure 6** Preferred Symbol Programming Options

Preferred Symbol

Preferred Symbol [What is this?](#)

Options

**Prioritized symbologies**

Preferred Symbol Options  [Edit](#)

**Identify exact bar code**

Preferred symbol criteria [View / Edit](#)

Prioritization time (ms)  [What is this?](#)

## Data Parsing (UDI Scan+, Label Parse+ and Blood Bag Parse+)

Data Parsing allows a Zebra scanner to scan a UDI label, GS1 label, or Blood Bags with one or more barcodes encoded with multiple data fields (such as date of manufacture, expiration date, batch

number, GTIN, and SSCC) and transmit select data fields and not others, in a specific order to a host application. Wave the scanner over all the barcodes while holding the trigger.

The scanner finds and transmits only the required data fields, even if they are spread across multiple barcodes and on different sides of the container.

In addition, the scanner can insert field separators (such as tab, enter, and slash) to automate data entry into a host application.

Use 123 Scan to program your scanner. For more information on writing a Data Parsing Rule, refer to the Data Parsing (UDI, GS1 Label, Blood Bag) on Zebra Scanners User Guide at: [zebra.com/support](https://zebra.com/support). To watch a video on Creating a Data Parsing Rule using 123Scan, go to: [zebra.com/ScannerHowToVideos](https://zebra.com/ScannerHowToVideos).

### Scan a UDI Label using UDI Scan+

Government regulatory agencies (such as the United States Food and Drug Administration (FDA), European Commission, and International Medical Device Regulatory Forum) have established Unique Device Identification (UDI) standards to identify and monitor the distribution and use of medical devices within healthcare environments

These UDI standards identify medical devices from manufacturing through distribution to patient use - enabling complete traceability of the millions of individual medical devices utilized for patient care. To enable UDI compliance, all medical devices must carry a UDI label to enable “track and trace” from the point of production, during shipment, through the product’s use and disposal.

### Scan a GS1 Label using Label Parse+

The GS1 Organization, an international standards body, has released specifications used worldwide for generating shipping labels. These labels are used when shipping packages (logistics), raw materials and produce.

### Scan a Blood Bag Label using Blood Bag Parse+

The International Council for Commonality in Blood Banking Automation (CCBBA Organization, an international standards body, has released a worldwide specification for generating blood bag labels. These labels are used when shipping, storing, and using blood bags.



**NOTE:** For more information, go to: [isbt128.org/tech-library/iccbba-documents/standards-documents/standard-labeling-blood](https://isbt128.org/tech-library/iccbba-documents/standards-documents/standard-labeling-blood).



# Data Capture

This section provides information on aiming, illumination, data capture, beeper and decode LED feedback, supported symbologies, and operating modes.

## Aiming the Device

When scanning, the device projects an aiming pattern that allows positioning the barcode within its field of view. If necessary, the scanner turns on its LED to illuminate the target barcode.

To scan a barcode, center the symbol and ensure the entire symbol is within the rectangular area formed by the illuminated LED. When off-centered, the scanner can also read a barcode presented within the aiming pattern. The following image illustrates proper LED placement to produce a successful decode.

**Figure 7** Aiming Pattern

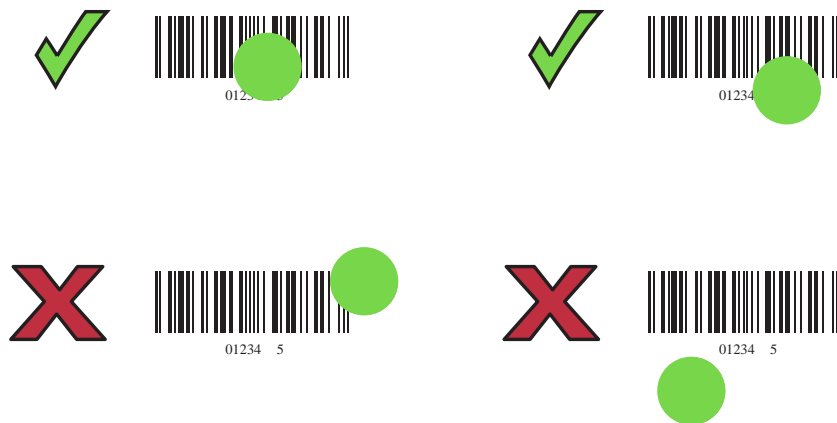

The aiming dot is smaller when the scanner is closer to the barcode and larger when it is farther away. Scan barcodes with smaller bars or elements closer to the scanner and those with larger bars or elements farther from the scanner.

The scanner beeps to indicate that it successfully decoded the barcode. For more information on beeper and LED definitions, go to [Scanner Indications](#) on page 59.

## Presentation Mode Scanning

In Presentation Mode (default) during idle conditions, the scanner operates in object detection mode and automatically wakes up to decode a barcode presented in the field of view. In object detection mode, it is normal for the illumination LEDs to be dimly lit.



**NOTE:** Alternatively, configure the device to use scene detect mode, in which the device keeps the light off (go to [Low Light Scene Detection](#) on page 144) and only turns it on during an active decode state (go to [Motion Detect Mode \(Wakeup\)](#) on page 141).

1. Ensure all connections are secure.
2. Present the barcode in the scanner's field of view.
3. Upon successful decode, the scanner beeps, and the LED flashes green.

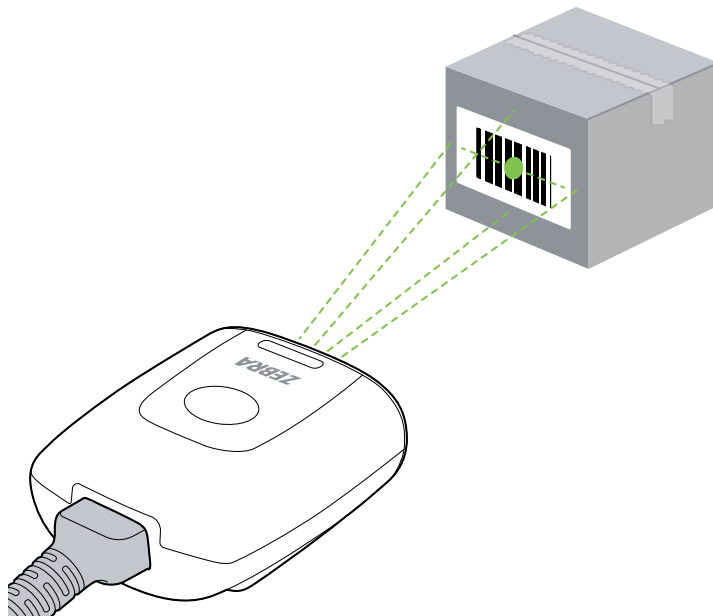

In scene detect mode, the device keeps the light off and only turns it on when it transitions from this mode to an active decode state.

## Trigger Mode Scanning

Capture barcode data in trigger mode by using the device's built-in trigger.

1. Ensure all connections are secure.
2. Point the scanner at the barcode.
3. Press and hold the trigger button.

4. Upon successful decode, the scanner beeps, and the LED flashes green.

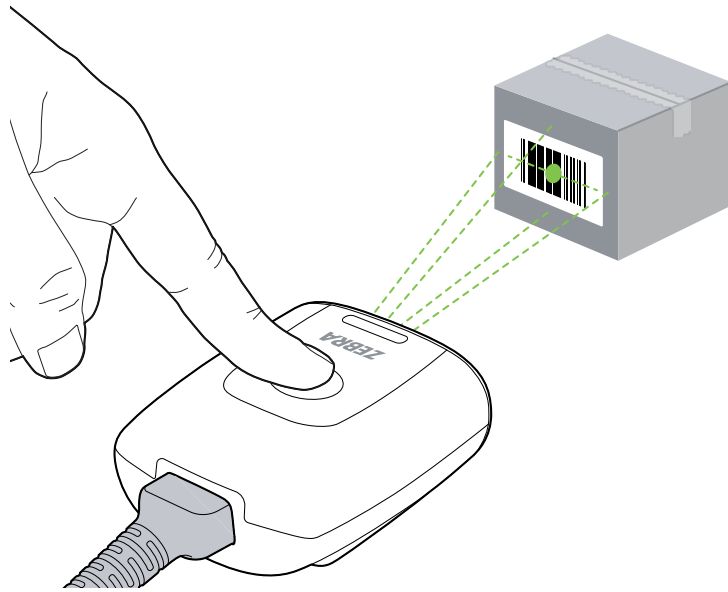

## Illumination System

The illumination system consists of the embedded scan engine, which features a green LED aimer with a circular dot pattern and white LEDs for scene illumination. The sophisticated drive system allows image capturing and decoding throughout a range of lighting conditions (total darkness to full sunlight).

## Illumination Control

The device can capture images with the illumination subsystem turned on or off, accommodating images that are close to the wavelength of illumination. For example, because the scanner uses green LED illumination, it may be desirable to shut it off when capturing an image printed in green ink.

It is recommended to turn off LED illumination and provide a minimum of 30 fcd ambient light on the document surface when taking images of documents. Even a small amount of dust or fingerprints on the scanner window can scatter the LED illumination and create glare in the image. The glare reduces the quality of document images but does not affect barcode reading.

## Scanner Indications

This section provides beeper and LED indications.

**Table 7** Scanner Indications

LED	Tone Sequence	Description
Standard Use		
Green (stays on)	Low/medium/high beeps	Scanner has power.

**Table 7** Scanner Indications (Continued)

LED	Tone Sequence	Description
(Hands-free) Solid Green LED; turns off after decode.	Medium Beep (or as configured)	Good decode.
(Handheld) LED is off; green upon decode		
Green (blink continuous)	Low beep	Snapshot started.
Red (stays on)	None	Scanner error.
Red (blink continuous)	None	Flashing new software.
Image Capture		
Green (blinking)	Low beep	Snapshot mode started.
Default Green LED based upon hand-held or hands-free mode.	Low beep	Snapshot mode completed.
Default Green LED based upon hand-held or hands-free mode.	High/low beep	Snapshot mode timed-out.
Parameter Programming		
Red	Long low/long high beeps	Input error; incorrect barcode or <b>Cancel</b> scanned, wrong entry, incorrect barcode programming sequence; remain in program mode.
Green	High/low beeps	Number expected. Enter value using numeric barcodes.
Green	High/low/high/low beeps	Successful program exit with change in the parameter setting.
ADF Programming		
None	Low/high/low beeps	ADF transmit error.
Green	High/low beeps	Number expected. Enter another digit. Add leading zeros to the front if necessary.
Green	Low/low beeps	Alphanumeric expected. Enter another alphanumeric character or scan the <b>End of Message</b> barcode.
Green blinking	High/high beeps	ADF criteria or action is expected. Enter another criteria or action or scan the <b>Save Rule</b> barcode.
Green	High/low/low beeps	All criteria or actions cleared for current rule, continue entering rule.
Green; turns off after blinking.	High/low/high/low beeps	Rule saved. Rule entry mode exited.

**Table 7** Scanner Indications (Continued)

LED	Tone Sequence	Description
Red	Long low/long high beeps	Rule error. Entry error, wrong barcode scanned, or criteria/action list is too long for a rule. Re-enter criteria or action.
Green	Low beep	Deleted last saved rule. The current rule is left intact.
Green	Low/high/high beeps	All rules deleted.
Red	Long low/long high/long low/long high beeps	Out of rule memory. Erase some existing rules, then try to save rule again.
Green; turns off after blinking.	Long low/long high/long low beeps	Cancel rule entry. Rule entry mode exited because of an error or the user asked to exit rule entry.
Host Specific (USB only)		
None	Four high beeps	Scanner has not completed initialization. Wait several seconds and scan again.
Host Specific (RS-232 only)		
Red	Low/low/low/extra low beeps	RS-232 receive error (parity error).
None	High beep	A <BEL> character is received when Beep on <BEL> is enabled (Point-to-Point mode only).
123Scan only (When in use, the utility controls the scanner LED).		
Green (slow blinking)	None	Scanner connected to 123Scan.
Red (fast blinking)	None	File being transferred to the scanner (parameters and firmware).
Red (slow blinking)	None	Firmware being activated on the scanner, loaded into memory.
Green (solid)	None	Programming completed successfully (parameters and firmware).
Red (solid)	None	Error state.
SMS only		
Red (blinking)	None	Loading the SMS package to scanner.
Maintenance Indications		
Red (stays on)	High/high beeps	Enter Bootloader.
Red (blinking)	None	Firmware installation.
Macro PDF		
None	Low/low beeps	Buffered File ID error. A barcode not in the current MPDF sequence was scanned.
None	Long low/long low beeps (2 long low beeps)	File ID error. A barcode not in the current MPDF sequence was scanned.

**Table 7** Scanner Indications (Continued)

LED	Tone Sequence	Description
None	Long low/long low/long low beeps (3 long low beeps)	Out of memory. There is not enough buffer space to store the current MPDF symbol.
None	Long low/long low/long low/long low beeps (4 long low beeps)	Bad symbology. Scanned a 1D or 2D barcode in an MPDF sequence, a duplicate MPDF label, a label in an incorrect order, or trying to transmit an empty or illegal MPDF field.
None	Long low/long low/long low/long low/long low beeps (5 long low beeps)	Flushing MPDF buffer.
None	Fast warble	Aborting MPDF sequence.
None	Low/high beeps	Flushing an already empty MPDF buffer.

## Supported Symbologies

The following barcode types are supported and can be individually enabled or disabled.

**Table 8** 1D/2D Symbologies

1D Symbologies		2D Symbologies	
Symbology	Variant	Symbology	Variant
Code 39	Standard	PDF-417	Standard
	Full ASCII		Macro
	Code 32 / Italian Pharmacode	Micro PDF-417	Standard
	Trioptic		Macro
Code 128	Standard	Composite	CC-A
	Full ASCII		CC-B
	EAN-128		CC-C
	ISBT-128	TLC-39	None
Code 93	None	Postal Codes	-
Codabar (NW7)	Standard	Aztec	-
	ABC	Chinese Hanxin	-
	Ames	Grid Matrix	-
Code 11	Standard	Securpharm	-
	Matrix 2 of 5		
	Chinese 2 of 5		
MSI Plessey	None		

**Table 8** 1D/2D Symbologies (Continued)

1D Symbologies		2D Symbologies	
Scanlets	None		
UPC/EAN	UPCA (+ supplementals)		
	UPCE (+ supplementals)		
	UPCE1 (+ supplementals)		
	EAN-8 (+ supplementals)		
	EAN-13 (+ supplementals)		
	JAN-8 (+ supplementals)		
	JAN-13 (+ supplementals)		
	EAN / Bookland		
	ISSN		
	Coupon Code		
2 of 5	Interleaved 2 of 5 / ITF		
	Discrete 2 of 5		
	IATA		
	Febraban		
Code 49	None		
GS1 Databar RSS	Limited		
	RSS-14		
	Expanded		
	Inverse		
LAETUS Pharmacode	-		
Composite	CC-A		
	CC-B		
	CC-C		
TLC-39	None		

**Table 9** Other Symbologies

Symbology	Variant	Type
DataMatrix	ECC 200	Matrix
GS1 DataMatrix	ECC 140	Matrix
	ECC 100	Matrix

**Table 9** Other Symbologies (Continued)

Symbology	Variant	Type
	ECC 080	Matrix
	ECC 050	Matrix
QR Code	-	Matrix
Maxicode	-	Matrix

## Operating Modes

**Trigger Mode** - For decoding barcodes using the device's hardware trigger or a computer software trigger.

**Presentation Mode (Default)** - A hands-free mode for decoding barcodes, with or without scanner illumination.

**Snapshot Mode** - A mode used for capturing an image.

**Snapshot Mode with Viewfinder Mode** - Provides a video of the subject until a snapshot of the image is captured.



# Maintenance and Troubleshooting

This section provides information on maintenance and troubleshooting.

## Maintaining the Device

Keep the DS5502 clean and dry to ensure error-free scanning. To avoid damaging a DS5502 device - regardless of its housing color - only use the approved cleaning and disinfecting agents listed below. The use of non-approved cleaning or disinfecting agents may void the warranty.

### Known Harmful Ingredients

The following chemicals are known to damage the plastics on Zebra scanners and should not come in contact with the device:

- Acetone
- Ammonia solutions
- Aqueous or alcoholic alkaline solutions
- Aromatic and chlorinated hydrocarbons
- Benzene
- Carboic acid
- Compounds of amines or ammonia
- Ethanolamine
- Ethers
- Ketones
- TB-lysoform
- Toluene
- Trichloroethylene

### Approved Cleaners for the Scanner

- Mild dish soap.
- Isopropyl alcohol 70% (including wipes).

- 3% Hydrogen peroxide solution.

### Cleaning the Scanner

To clean the scanner:

- Clean the scanner housing and exit window with a damp cloth and, if necessary, a non-ammonia-based detergent.
- Do not allow any abrasive material to touch the exit window.

### Cleaning the Connector

Follow these steps to clean the connector.

1. Remove the cable connector from the scanner.
2. Rub a cotton-tipped applicator dipped in isopropyl alcohol back and forth across the connector pins. Do not leave any cotton residue on the connector.
3. Rub a dry cotton-tipped applicator back and forth across the connector pins.
4. Spray compressed air on the connector area by pointing the tube/nozzle approximately 12.7 mm (0.5 in) from the surface.
5. Inspect the area for any grease or dirt and repeat if required.



**NOTE:** Do not get excess alcohol onto the soft elastomeric gasket since this can compromise the adhesion to the housing and ultimately the gasket's ability to prevent liquids from entering the scanner in this area during normal operation.

## Troubleshooting

This section provides information for troubleshooting the scanner.

Problem	Possible Cause	Possible Solutions
No green LED or nothing happens during a capture attempt.	No power to the scanner.	Check the system power.
		Connect the power supply.
		Re-connect loose cables.
Scanner cannot read the barcode.	Interface/power cables are loose.	Re-connect loose cables.
	Scanner is not programmed for the correct barcode type.	Program the scanner to read the type of barcode to be decoded.
	Incorrect communication parameters.	Set the correct communication parameters (baud rate, parity, stop bits, etc.).
	Barcode symbol is unreadable.	Ensure the symbol is not defaced. Try capturing similar symbols of the same code type.

Problem	Possible Cause	Possible Solutions
Illumination and aim pattern does not appear.	Hot environment.	Remove the scanner from the hot environment and allow it to cool down.
LED activates, followed by a beep sequence.	Beeper is configured.	Go to <a href="#">Scanner Indications</a> on page 59 for beeper indication descriptions.
<div style="display: flex; align-items: flex-start;"> <div style="margin-right: 10px;">  </div> <div> <p><b>NOTE:</b> If the symbol fails to decode even after performing the mentioned checks, refer to either the distributor or Zebra Global Customer Support.</p> </div> </div>		

# Specifications

This section provides information regarding the scanner's technical specifications and decode ranges.

## DS5502 Technical Specifications

**Table 10** DS5502 Scanner Specifications

Item	Description
Physical Characteristics	
Height	3.0 cm (1.2 in)
Length	7.2 cm (2.8 in)
Width	5.6 cm (2.2 in)
Weight	67 g (2.4 oz)
Input Voltage Range	4.75 to 5.25 VDC host powered 4.75 to 5.25 VDC external power supply
Operating Current at Nominal Voltage (5.0V)	500 mA max
Idle Current at Nominal Voltage (5.0V)	Presentation mode: 185 mA RMS (typical) Trigger mode: 155 mA RMS (typical)
Operating Current at Nominal Voltage (5.0V)	Presentation mode: 360 mA RMS (typical) Trigger mode: 350 mA RMS (typical)
Color	Alpine White, Midnight Black
Supported Host Interfaces	USB, RS232, TGCS
Keyboard Support	USB Country Codes
User Indicators	Good decode LED, beeper tone, and volume adjustable
Performance Characteristics	
Swipe Speed (Presentation)	Up to 254 cm (100 in) per second for 13 mil UPCA in optimized mode
Light Source	Green LED for aiming with a circular dot pattern

**Table 10** DS5502 Scanner Specifications (Continued)

Item	Description
Illumination	White LED for scene illumination
Scanner Field of View	48° H x 30° V nominal
Image Sensor	1280 x 800 pixels
Minimum Print Contrast	15%
Skew Tolerance	+/- 60°
Pitch Tolerance	+/- 60°
Roll Tolerance	0–360°
Symbology Decode Capabilities	
1D	Code 39, Code 128, Code 93, Codabar/NW7, Code 11, MSI Plessey, UPC/EAN, 2 of 5, GS1 DataBar, Code 49
2D	PDF417, Micro PDF417, Composite Codes, TLC-39, Aztec, DataMatrix, MaxiCode, QR Code, Micro QR, Han Xin, Postal Codes, securPharm, DotCode, Grid Matrix
User Environment	
Operating Temperature	-20.0–50.0° C (-4.0–122.0° F)
Storage Temperature	-40.0–70.0° C (-40.0–158.0° F)
Humidity	5% to 95% RH, non-condensing
Drop / Impact Shock Specification	Designed to withstand multiple drops at 1.5 m to concrete
Environmental Sealing	IP54
Electrostatic Discharge (ESD)	ESD per EN61000-4-2, +/-15 KV Air, +/-8 KV indirect
Ambient Light Immunity	Sunlight: 0–108,000 lux (0–10,000 foot-candles) Artificial indoor light: 4845 lux (<450 ft-candles)
Interfaces	
Interfaces Supported	RJ50 to USB-A or RS232 TTL level RS232 with RTS and CTS
Regulatory	
Environmental	RoHS - EN IEC 63000:2018 Amendment 2015/863 WEEE RECAST 2012/19/EU China RoHS - SJ/T 11364 REACH - EC 1907/2006

**Table 10** DS5502 Scanner Specifications (Continued)

Item	Description
Electrical Safety	EN 62368-1:2014/AC:2015 EN 62368-1:2014/A11:2017 IEC 62368-1:2014 EN IEC 62368-1:2020+A11:2020 IEC 62368-1:2018 UL 62368-1, third edition CAN/CSA-C22.2 No. 62368-1-19
LED Safety	EN 62471, IEC 62471 plus all amendments and all national deviations
EMI/RFI	FCC 47 CFR Part 15B, ICES-003, EN55032, EN55035, EN61000-6-2, EN60601-1-2, IEC60601-1-2, VCCI, and SABS
 <b>NOTE:</b> Environmental and/or tolerance parameters are not cumulative. If the application is subject to an extreme temperature environment, perform a thermal analysis.	

## Decode Ranges

**Table 11** Decode Ranges - Trigger Mode

Symbology/Resolution	Typical Decode Ranges - Trigger Mode	
	Near	Far
3 mil Code 39	7.1 cm (2.8 in)	14.2 cm (5.6 in)
4 mil Code 39	6.1 cm (2.4 in)	20.3 cm (8 in)
5 mil Code 39	4.1 cm (1.6 in)	25.4 cm (10 in)
7.5 mil Code 39	5.3 cm (2.1 in)	38.1 cm (15 in)
20 mil Code 39	4.1 cm (1.6 in)	91.2 cm (35.9 in)
3 mil Code 128	7.4 cm (2.9 in)	14.0 cm (5.5 in)
5 mil Code 128	5.3 cm (2.1 in)	24.4 cm (9.6 in)
6.67 mil PDF 417	5.8 cm (2.3 in)	25.1 cm (9.9 in)

**Table 11** Decode Ranges - Trigger Mode (Continued)

Symbology/Resolution	Typical Decode Ranges - Trigger Mode	
	Near	Far
10 mil Datamatrix	4.8 cm (1.9 in)	27.4 cm (10.8 in)
13 mil UPCA (100%)	4.1 cm (1.6 in)	62.7 cm (24.7 in)
20 mil QR Code	2.3 cm (0.9 in)	43.9 cm (17.3 in)

**Table 12** Decode Ranges - Presentation Mode

Symbology/Resolution	Typical Decode Ranges - Trigger Mode	
	Near	Far
3 mil Code 39	7.1 cm (2.8 in)	14.2 cm (5.6 in)
4 mil Code 39	6.1 cm (2.4 in)	20.3 cm (8 in)
5 mil Code 39	4.1 cm (1.6 in)	22.9 cm (9 in)
7.5 mil Code 39	5.6 cm (2.2 in)	25.4 cm (10 in)
20 mil Code 39	5.1 cm (2 in)	45.7 cm (18 in)
3 mil Code 128	7.4 cm (2.9 in)	14.0 cm (5.5 in)
5 mil Code 128	5.3 cm (2.1 in)	21.6 cm (8.5 in)
6.7 mil PDF 417	5.8 cm (2.3 in)	22.6 cm (8.9 in)
10 mil Datamatrix	4.8 cm (1.9 in)	24.1 cm (9.5 in)
13 mil UPCA (100%)	4.1 cm (1.6 in)	35.6 cm (14 in)
20 mil QR Code	2.3 cm (0.9 in)	35.6 cm (14 in)

# SSI Interface

This section describes the system requirements of the Simple Serial Interface (SSI), which provides a communications link between Zebra decoders (e.g., scan engines, slot scanners, hand-held scanners, two-dimensional scanners, hands-free scanners, and RF base stations) and a serial host. It provides the means for the host to control the decoder or scanner.

## Communication

All communication between the scanner and host occurs over the hardware interface lines using the SSI protocol. Refer to the Simple Serial Interface Programmer's Guide, p/n 72E-40451-xx, for more information on SSI.

The host and the scanner exchange messages in packets. A packet is a collection of bytes framed by the proper SSI protocol formatting bytes. The maximum number of bytes per packet that the SSI protocol allows for any transaction is 257 (255 bytes + 2 byte checksum).

Depending on the configuration, the scanner can send decode data as ASCII data (unpacked), or as part of a larger message (packeted).

SSI performs the following functions for the host device:

- Maintains a bi-directional interface with the scanner
- Allows the host to send commands that control the scanner
- Passes data from the scanner to a host device in SSI packet format or straight decode message.

The SSI environment consists of a scanner, a serial cable which attaches to the host device, and if required, a power supply.

SSI transmits all decode data including special formatting (for example, AIM ID). Parameter settings can control the format of the transmitted data.

The scanner can also send parameter information, product identification information, or event codes to the host.

All commands sent between the scanner and host must use the format described in the SSI Message Formats section. [SSI Transactions](#) describes the required sequence of messages in specific cases.

## SSI Commands

The following table lists all the SSI opcodes the scanner supports. The host transmits opcodes designated type H. The scanner (decoder) transmits type D opcodes and transmits Host/Decoder (H/D) types.



**Table 13** SSI Commands

Name	Type	Opcode	Description
AIM_OFF	H	0xC4	Deactivate aiming pattern.
AIM_ON	H	0xC5	Activate aiming pattern.
BEEP	H	0xE6	Sound the beeper.
CAPABILITIES_REPLY	D	0xD4	Reply to CAPABILITIES_REQUEST; contains a list of the capabilities and commands the decoder supports.
CAPABILITIES_REQUEST	H	0xD3	Request capabilities report from the decoder.
CMD_ACK	H/D	0xD0	Positive acknowledgment of received packet.
CMD_NAK	H/D	0xD1	Negative acknowledgment of received packet.
DECODE_DATA	D	0xF3	Decode data in SSI packet format.
EVENT	D	0xF6	Event indicated by associated event code.
LED_OFF	H	0xE8	De-activate LED output.
LED_ON	H	0xE7	Activate LED output.
PARAM_DEFAULTS	H	0xC8	Set parameter default values.
PARAM_REQUEST	H	0xC7	Request values of certain parameters.
PARAM_SEND	H/D	0xC6	Send parameter values.
REPLY_REVISION	D	0xA4	Reply to REQUEST_REVISION, contains the decoder's software/hardware configuration.
REQUEST_REVISION	H	0xA3	Request the decoder's configuration.
SCAN_DISABLE	H	0xEA	Prevent the operator from scanning barcodes.
SCAN_ENABLE	H	0xE9	Permit barcode scanning.
SLEEP	H	0xEB	Request to place the decoder into low power.
START_DECODE	H	0xE4	Tell the decoder to attempt to decode a barcode.
STOP_DECODE	H	0xE5	Tell the decoder to abort a decode attempt.
WAKEUP	H	N/A	Wake the decoder from low power mode.

For details of the SSI protocol, refer to the Simple Serial Interface Programmer's Guide.

## SSI Transactions

### General Data Transactions

This section describes general data transactions between the scanner and a host.

#### ACK/NAK Handshaking

If you enable ACK/NAK handshaking (the default), all packeted messages must have a CMD\_ACK or CMD\_NAK response, unless the command description states otherwise. Zebra recommends leaving this

handshaking enabled to provide feedback to the host. Raw decode data and WAKEUP do not use ACK/NAK handshaking since they are not packeted data.

Following is an example of a problem which can occur if you disable ACK/NAK handshaking:

- The host sends a PARAM\_SEND message to the scanner to change the baud rate from 9600 to 19200.
- The scanner cannot interpret the message.
- The scanner does not implement the change the host requested.
- The host assumes that the parameter change occurred and acts accordingly.
- Communication is lost because the change did not occur on both sides.

If you enable ACK/NAK handshaking, the following occurs:

- The host sends a PARAM\_SEND message.
- The scanner cannot interpret the message.
- The scanner CMD\_NAKs the message.
- The host resends the message.
- The scanner receives the message successfully, responds with CMD\_ACK, and implements parameter changes.

## Decoded Data Transmission

The [Decode Data Packet Format](#) parameter controls how decode data is sent to the host. Set this parameter to send the data in a DECODE\_DATA packet. Clear this parameter to transmit the data as raw ASCII data.



**NOTE:** When transmitting decode data as raw ASCII data, ACK/NAK handshaking does not apply regardless of the state of the ACK/NAK handshaking parameter.

### ACK/NAK Enabled and Packeted Data

The scanner sends a DECODE\_DATA message after a successful decode. The scanner waits for a programmable timeout for a CMD\_ACK response. If it does not receive the response, the scanner tries to send two more times before issuing a host transmission error. If the scanner receives a CMD\_NAK from the host, it may attempt a retry depending on the cause field of the CMD\_NAK message.

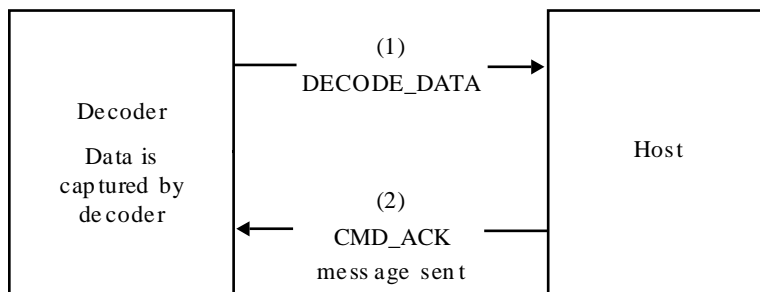

### ACK/NAK Enabled and Unpacketed ASCII Data

Even if ACK/NAK handshaking is enabled, no handshaking occurs because handshaking applies only to packeted data. In this example the packeted\_decode parameter is disabled.

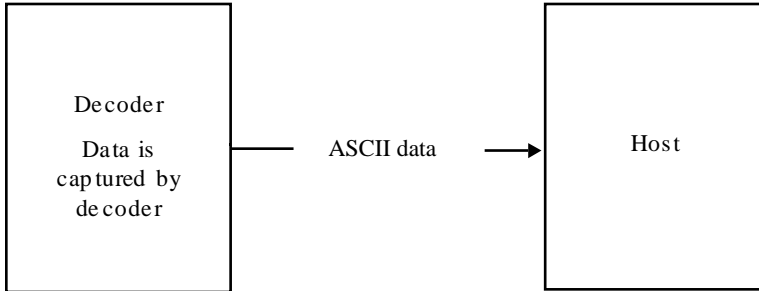

## ACK/NAK Disabled and Packeted DECODE\_DATA

In this example ACK/NAK does not occur even though packeted\_decode is enabled because the ACK/NAK handshaking parameter is disabled.

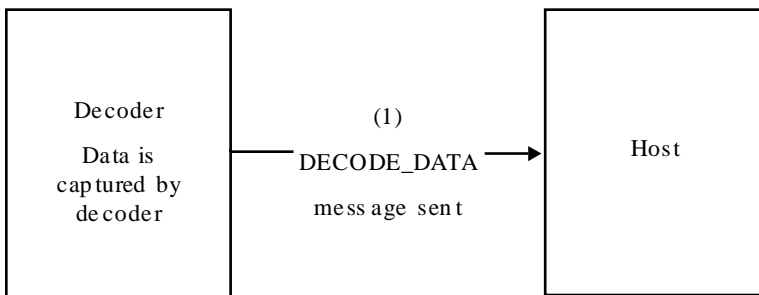

## ACK/NAK Disabled and Unpacketed ASCII Data

The decoder sends captured data to the host.

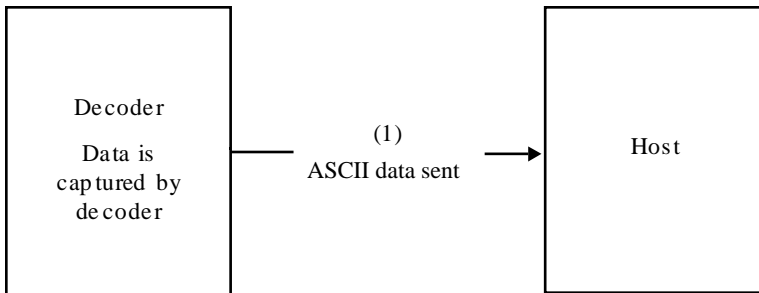

## Communication Summary

### RTS/CTS Lines

All communication must use RTS/CTS handshaking as described in the Simple Serial Interface Programmer's Guide, p/n 72E-40451-xx. If bypassing hardware handshaking, the host must send the WAKEUP command before all other communication or the first byte of a message can be lost during the scanner wakeup sequence. Zebra recommends not bypassing RTS/CTS hardware handshaking.

## ACK/NAK Option

ACK/NAK handshaking is enabled by default and Zebra recommends leaving it enabled. Disabling this can cause communication problems, as handshaking is the only acknowledgment that a message was received correctly. ACK/NAK is not used with unpacketed decode data regardless of whether it is enabled.

## Number of Data Bits

All communication with the scanner must use 8-bit data.

## Serial Response Timeout

The [Host Serial Response Timeout](#) parameter determines how long to wait for a handshaking response before trying again or aborting further attempts. Set the same value for both the host and scanner.



**NOTE:** You can temporarily change the [Host Serial Response Timeout](#) when the host takes longer to process an ACK or longer data string. Zebra does not recommend frequent permanent changes due to limited write cycles of non-volatile memory.

## Retries

The host resends data twice after the initial send if the scanner does not respond with an ACK or NAK (if ACK/NAK handshaking is enabled), or response data (for example, PARAM\_SEND, REPLY\_REVISION). If the scanner replies with a NAK RESEND, the host resends the data. All resent messages must have the resend bit set in the Status byte.

The scanner resends data two times after the initial send if the host fails to reply with an ACK or NAK (if ACK/NAK handshaking is enabled).

## Baud Rate, Stop Bits, Parity, Response Timeout, ACK/NAK Handshaking

If you use PARAM\_SEND to change these serial parameters, the ACK response to the PARAM\_SEND uses the previous values for these parameters. The new values then take effect for the next transaction.

## Errors

The scanner issues a communication error when:

- The CTS line is asserted when the scanner tries to transmit, and is still asserted on each of two successive retries
- The scanner does not receive an ACK or NAK after initial transmit and two resends.

## SSI Communication Notes

- When not using hardware handshaking, space messages sufficiently apart. The host must not communicate with the scanner if the scanner is transmitting.
- When using hardware handshaking, frame each message properly with handshaking signals. Do not try to send two commands within the same handshaking frame.
- There is a permanent/temporary bit in the PARAM\_SEND message. Removing power from the scanner discards temporary changes. Permanent changes are written to non-volatile memory. Frequent changes shorten the life of the non-volatile memory.

## Using Time Delay to Low Power Mode with SSI

[Time Delay to Low Power Mode](#) provides options to select a general time delay. To program a more specific delay value, use an SSI command according to the following values.

**Table 14** Values for Selecting Time Delay to Low Power

Value	Timeout	Value	Timeout	Value	Timeout	Value	Timeout
0x00	15 Min	0x10	1 Sec	0x20	1 Min	0x30	1 Hour
0x01	30 Min	0x11	1 Sec	0x21	1 Min	0x31	1 Hour
0x02	60 Min	0x12	2 Sec	0x22	2 Min	0x32	2 Hours
0x03	90 Min	0x13	3 Sec	0x23	3 Min	0x33	3 Hours
N/A	N/A	0x14	4 Sec	0x24	4 Min	0x34	4 Hours
N/A	N/A	0x15	5 Sec	0x25	5 Min	0x35	5 Hours
N/A	N/A	0x16	6 Sec	0x26	6 Min	0x36	6 Hours
N/A	N/A	0x17	7 Sec	0x27	7 Min	0x37	7 Hours
N/A	N/A	0x18	8 Sec	0x28	8 Min	0x38	8 Hours
N/A	N/A	0x19	9 Sec	0x29	9 Min	0x39	9 Hours
N/A	N/A	0x1A	10 Sec	0x2A	10 Min	0x3A	10 Hours
N/A	N/A	0x1B	15 Sec	0x2B	15 Min	0x3B	15 Hours
N/A	N/A	0x1C	20 Sec	0x2C	20 Min	0x3C	20 Hours
N/A	N/A	0x1D	30 Sec	0x2D	30 Min	0x3D	30 Hours
N/A	N/A	0x1E	45 Sec	0x2E	45 Min	0x3E	45 Hours
N/A	N/A	0x1F	60 Sec	0x2F	60 Min	0x3F	60 Hours



**NOTE:** With hardware handshaking disabled, the scanner wakes from low power mode upon receiving a character. However, the scanner does not process this character or any others it receives during the period following wakeup. Wait at least after wakeup to send valid characters.

## Encapsulation of RSM Commands/Responses over SSI

The SSI protocol allows the host to send a command that is variable in length up to 255 bytes. Although there is a provision in the protocol to multi-packet commands from the host, the scanner does not support this. The host must fragment packets using the provisions in the RSM protocol.

### Command Structure

Byte	7	6	5	4	3	2	1	0
0	Length (not including the checksum)							
1	SSI_MGMT_COMMAND (0x80)							
2	Message Source (4 - Host)							

Byte	7	6	5	4	3	2	1	0
3	Reserved (0)				Reserved (0)	Reserved (0)	Cont'd packet	Retransmit
4	Payload data (see the following example)							
...								
Length -1								
Length	2's complement checksum (MSB)							
Length +1	2's complement checksum (LSB)							

The expected positive response is SSI\_MGMT\_COMMAND which can be a multi-packet response. Devices that do not support this command respond with the standard SSI\_NAK.

## Response Structure

Byte	7	6	5	4	3	2	1	0
0	Length (not including the checksum)							
1	SSI_MGMT_COMMAND (0x80)							
2	Message Source (0 - Decoder)							
3	Reserved (0)				Reserved (0)	Reserved (0)	Cont'd packet	Retransmit
4	Payload data (see the following example)							
...								
Length -1								
Length	2's complement checksum (MSB)							
Length +1	2's complement checksum (LSB)							

## Example Transaction

The following example illustrates how to retrieve diagnostic information (Diagnostic Testing and Reporting - Attribute #10061- decimal) from the scanner using encapsulation of RSM commands over SSI. Before sending an RSM command, the host must send the RSM Get Packet Size command to query the packet size supported by the device.

### Command from Host to Query Packet Size Supported by Device

```
0A 80 04 00 00 06 20 00 FF FF FD 4E
```

Where:

- 0A 80 04 00 is encapsulation of RSM commands over SSI command header
- 00 06 20 00 FF FF is RSM Get Packet Size command
- FD 4E is SSI command checksum

## Response from Device with Packet Size Information

```
0C 80 00 00 00 08 20 00 00 F0 00 F0 FD 6C
```

Where:

- 0C 80 00 00 is encapsulation of RSM command over SSI command header
- 00 08 20 00 00 F0 00 F0 is RSM Get Packet Size response
- FD 6C is SSI response checksum

## Command from Host to Retrieve Diagnostic Information

```
0C 80 04 00 00 08 02 00 27 4D 42 00 FE B0
```

Where:

- 0C 80 04 00 is encapsulation of RSM commands over SSI command header
- 00 08 02 00 27 4D 42 00 is attribute Get command requesting attribute 10061 decimal
- FE B0 is SSI command checksum

## Response from Device with Diagnostic Information

```
21 80 00 00 00 1D 02 00 27 4D 41 01 42 00 0E 00 00 00 00 01 03 02 03 03 04  
03 05 03 06 03 FF FF FC 15
```

Where:

- 21 80 00 00 00 1D 02 00 27 4D 41 01 42 00 0E 00 00 is encapsulation of RSM responses over SSI command header
- 00 00 01 03 02 03 03 03 04 03 05 03 06 03 is attribute Get response which includes diagnostic report value
- FF FF is attribute Get response, packet termination
- FC 15 is SSI response checksum

## Setting SSI Parameters

You can set up a scanner with an SSI host. When using SSI, program the scanner via barcode menu or SSI hosts commands

The scanner ships with the settings shown in SSI Interface Defaults (also see for all defaults). If the default values suit requirements, programming is not necessary.

To set feature values, scan a single barcode or a short barcode sequence. The settings are stored in non-volatile memory and are preserved even when the scanner powers down.



**NOTE:** Most computer monitors allow scanning barcodes directly on the screen. When scanning from the screen, be sure to set the document magnification to a level where you can see the barcode clearly, and bars and/or spaces do not merge.

To return all features to default values, scan [Set Factory Defaults](#). Throughout the programming barcode menus, asterisks (\*) indicate default values.

## SSI Scanning Sequence Examples

In most cases scanning one barcode sets the parameter value. For example, to set the baud rate to 19,200, scan the **Baud Rate 19,200** barcode under [Baud Rate](#). The scanner issues a fast warble beep and the LED turns green, signifying a successful parameter entry.

Other parameters require scanning several barcodes. See the parameter descriptions for this procedure.

## SSI Errors While Scanning

Unless otherwise specified, to correct an error during a scanning sequence, just re-scan the correct parameter.

## Simple Serial Interface Parameter Defaults

You can change these values in one of two ways:

- Scan the appropriate barcodes in this section. The new value replaces the standard default value in memory. To recall default parameter values, see [Default Parameters](#) on page 128.
- Download data through the device’s serial port using SSI. Hexadecimal parameter numbers appear in this section below the parameter title, and option values display in parentheses beneath the accompanying barcodes. Refer to the Simple Serial Interface (SSI) Programmer’s Guide for detailed instructions for changing parameters using this method.

**Table 15** SSI Interface Default Table

Parameter	Parameter Number	SSI Number	Default
SSI Host Parameters			
<a href="#">Select SSI Host</a>	N/A	N/A	N/A
<a href="#">SSI Baud Rate</a>	156	9Ch	9600
<a href="#">SSI Parity</a>	158	9Eh	None
<a href="#">Check Parity</a>	151	97h	Do Not Check
<a href="#">SSI Stop Bits</a>	157	9Dh	1 Stop Bit
<a href="#">Intercharacter Delay</a>	N/A	N/A	0 msec
<a href="#">Host RTS Line State</a>	154	9Ah	Low
<a href="#">Software Handshaking</a>	159	9Fh	ACK/NAK
<a href="#">Decode Data Packet Format</a>	238	EEh	Send Raw Decode Data
<a href="#">Host Serial Response Timeout</a>	155	9Bh	2 Seconds
<a href="#">Host Character Timeout</a>	239	EFh	200 msec
<a href="#">Multipacket Option</a>	334	F0h 4Eh	Multipacket Option 1
<a href="#">Interpacket Delay</a>	335	F0h 4Fh	0 msec
Event Reporting			
<a href="#">Decode Event</a>	256	F0h 00h	Disable



**Table 15** SSI Interface Default Table (Continued)

Parameter	Parameter Number	SSI Number	Default
Boot Up Event	258	F0h 02h	Disable
Parameter Event	259	F0h 03h	Disable



**NOTE:** SSI interprets Prefix, Suffix1, and Suffix2 values listed in [ASCII Character Sets](#) on page 334 differently than other interfaces. SSI does not recognize key categories, only the 3-digit decimal value. The default value of 7013 is interpreted as CR only.

## SSI Host Parameters

Scan barcodes to set SSI host parameters

### Select SSI Host

Use this parameter to select SSI as the host interface.

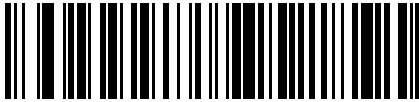

SSI Host

### SSI Baud Rate

#### Parameter # 156 (SSI # 9Ch)

Baud rate is the number of bits of data transmitted per second.

Select an option to set the scanner's baud rate to match the baud rate setting of the host device. Otherwise, data may not reach the host device or may reach it in distorted form.

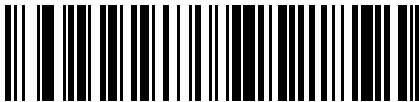

\*Baud Rate 9600 (6)



Baud Rate 19,200 (7)

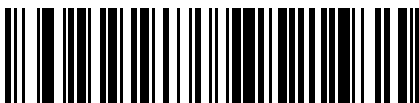

Baud Rate 38,400 (8)



Baud Rate 57,600 (10)

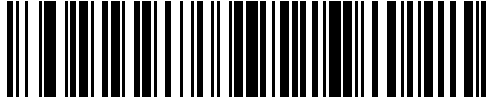

Baud Rate 115,200 (11)



Baud Rate 230,400 (13)

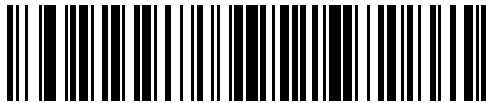

Baud Rate 460,800 (14)

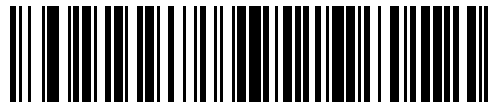

Baud Rate 921,600 (15)

## SSI Parity

### Parameter # 158 (SSI # 9Eh)

Choose whether code characters contain an odd or even number of 1 bits, or choose that no parity bit is required.

A parity check bit is the most significant bit of each ASCII coded character. Use this parameter to select the parity type according to host device requirements.

- Odd - This sets the parity bit value to 0 or 1, based on data, to ensure that the coded character contains an odd number of 1 bits.
- Even - This sets the parity bit value to 0 or 1, based on data, to ensure that the coded character contains an even number of 1 bits.
- None - No parity bit is required.

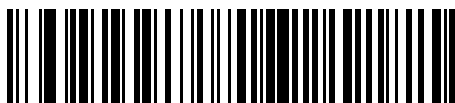

Odd (2)

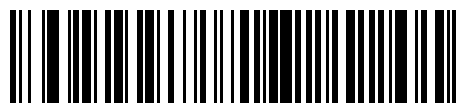

Even (1)



\*None (0)

## Check Parity

### Parameter # 151 (SSI # 97h)

Choose whether to check the parity of received characters.

Use this parameter to select whether to check the parity of received characters. See [SSI Parity](#) to select the type of parity.

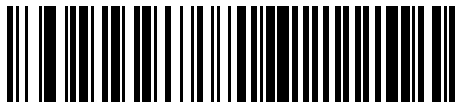

\*Do Not Check Parity (0)

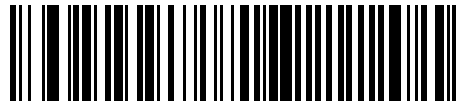

Check Parity (1)

## SSI Stop Bits

### Parameter # 157 (SSI # 9Dh)

The stop bit(s) at the end of each transmitted character marks the end of transmission of one character and prepares the receiving device for the next character in the serial data stream.

Select an option to set the number of stop bits (one or two) based on the number the receiving host can accommodate.



\*1 Stop Bit (1)



2 Stop Bits (2)

## Intercharacter Delay

This parameter specifies the intercharacter delay inserted between character transmissions.

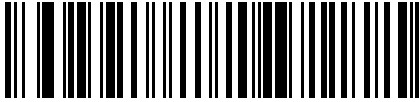

\*Minimum: 0 msec



Low: 25 msec

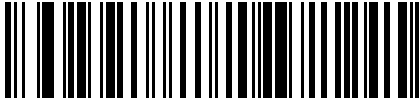

Medium: 50 msec



High: 75 msec

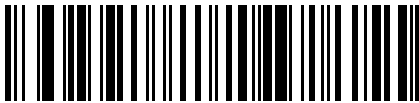

Maximum: 99 msec

## Software Handshaking

### Parameter # 159 (SSI # 9Fh)

This parameter offers control of data transmission in addition to the control hardware handshaking offers. Hardware handshaking is always enabled; you cannot disable it.

- Disable ACK/NAK Handshaking - The scanner neither generates nor expects ACK/NAK handshaking packets.
- Enable ACK/NAK Handshaking - After transmitting data, the scanner expects either an ACK or NAK response from the host. The scanner also ACKs or NAKs messages from the host. The scanner waits up to the programmable [Host Serial Response Timeout](#) to receive an ACK or NAK. If the scanner does not get a response in this time, it resends its data up to two times before discarding the data and declaring a transmission error.

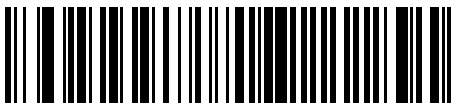

Disable ACK/NAK (0)

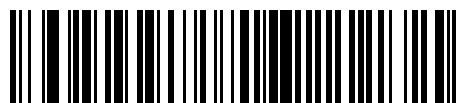

\*Enable ACK/NAK (1)

## Host RTS Line State

### Parameter # 154 (SSI # 9Ah)

This parameter sets the expected idle state of the Serial Host RTS line.

The SSI interface is used with host applications that also implement the SSI protocol. However, you can use the scanner in a "scan-and-transmit" mode to communicate with any standard serial communication software on a host PC (see [Decode Data Packet Format](#)). If transmission errors occur in this mode, the host PC may be asserting hardware handshaking lines that interfere with the SSI protocol. Scan the High barcode to address this problem.

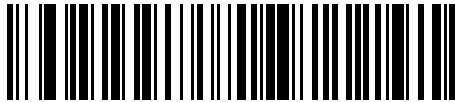

\*Low (0)

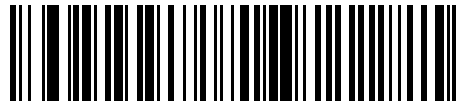

High (1)

## Decode Data Packet Format

### Parameter # 238 (SSI # EEh)

Use this parameter to select whether to transmit decoded data in raw format (unpacked), or with the packet format defined by the serial protocol.



**NOTE:** Selecting the raw format disables ACK/NAK handshaking for decode data.



\*Send Raw Decode Data (0)



Send Packeted Decode Data (1)

## Host Serial Response Timeout (SSI)

### Parameter # 155 (SSI # 9Bh)

This parameter specifies how long a scanner waits for an ACK or NAK before resending.

If the scanner wants to send, and the host has already been granted permission to send, the scanner waits for the designated timeout before declaring an error.



**NOTE:** Other values are available via SSI command.

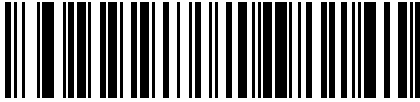

\*Low - 2 Seconds (20)



Medium - 5 Seconds (50)

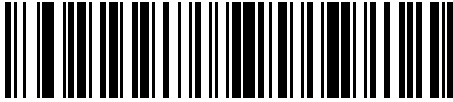

High - 7.5 Seconds (75)

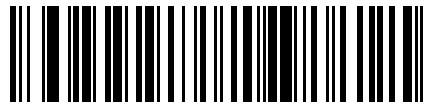

Maximum - 9.9 Seconds (99)

## Host Character Timeout

### Parameter # 239 (SSI # EFh)

This parameter specifies the maximum time a scanner waits between characters transmitted by the host before discarding the received data and declaring an error.

Select an option to specify the maximum time the scanner waits from Low to High.



**NOTE:** Other values are available via SSI command.

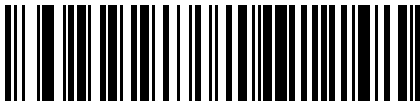

\*Low - 200 msec (20)



Medium - 500 msec (50)

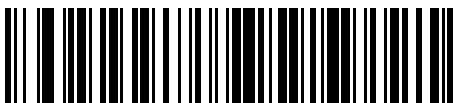

High - 750 msec (75)



Maximum - 990 msec (99)

## Multipacket Option

### Parameter # 334 (SSI # F0h 4Eh)

This parameter controls ACK/NAK handshaking for multi-packet transmissions.

- Multi-Packet Option 1 - The host sends an ACK/NAK for each data packet during a multi-packet transmission.
- Multi-Packet Option 2 - The scanner sends data packets continuously, with no ACK/NAK handshaking to pace the transmission. The host, if overrun, can use hardware handshaking to temporarily delay scanner transmissions. At the end of transmission, the scanner waits for a CMD\_ACK or CMD\_NAK.
- Multi-Packet Option 3 - This is the same as option 2 with the addition of a programmable interpacket delay. See [Interpacket Delay](#) to set this delay.

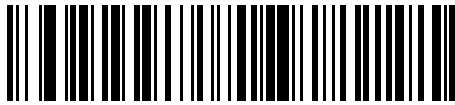

\*Multipacket Option 1 (0)



Multipacket Option 2 (1)

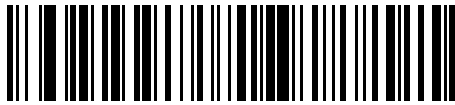

Multipacket Option 3 (2)

## Interpacket Delay

### Parameter # 335 (SSI # F0h 4Fh)

This parameter specifies the interpacket delay if you selected Multipacket Option 3.



**NOTE:** Other values are available via SSI command.

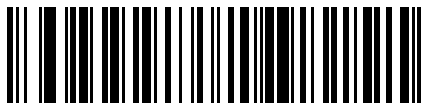

\*Minimum - 0 msec (0)



Low - 25 msec (25)



Medium - 50 msec (50)



High - 75 msec (75)



Maximum - 99 msec (99)

## Event Reporting

The host can request the scanner to provide certain information (events) relative to scanner behavior. Scan the following barcodes to enable or disable events.

**Table 16** Event Codes

Event Class	Event	Code Reported
Decode Event	Non-parameter decode	0x01
Boot Up Event	System power-up	0x03
Parameter Event	Parameter entry error	0x07
	Parameter stored	0x08
	Defaults set (and parameter event is enabled by default)	0x0A
	Number expected	0x0F

### Decode Event

**Parameter # 256 (SSI # F0h 00h)**

Use this parameter to enable or disable a non-parameter decode event.

- Enable Decode Event - scanner generates a message to the host upon a successful barcode decode.
- Disable Decode Event - no notification is sent.



Enable Decode Event (1)





\*Disable Decode Event (0)

## Boot Up Event

### Parameter # 258 (SSI # F0h 02h)

Use this parameter to enable or disable a system power-up event.

- Enable Boot Up Event - scanner generates a message to the host whenever power is applied.
- Disable Boot Up Event - no notification is sent.

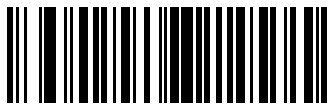

Enable Boot Up Event (1)



\*Disable Boot Up Event (0)

## Parameter Event

### Parameter # 259 (SSI # F0h 03h)

Use this parameter to enable or disable parameter events.

- Enable Parameter Event - scanner generates a message to the host when one of the events specified in [Event Reporting](#) occurs.
- Disable Parameter Event - no notification is sent.

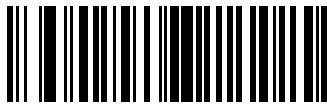

Enable Parameter Event (1)

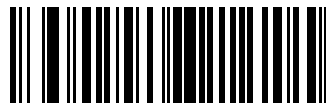

\*Disable Parameter Event (0)

# USB Interface

This section describes how to set up the scanner with a USB host. The scanner connects directly to a USB host, or a powered USB hub, which powers it.

The scanner ships with the settings shown in [USB Parameter Defaults](#) on page 91. If the default values suit requirements, programming is not necessary.

## USB Interface Connection

Connect the scanner directly to the host computer.

**Figure 8** USB Connection

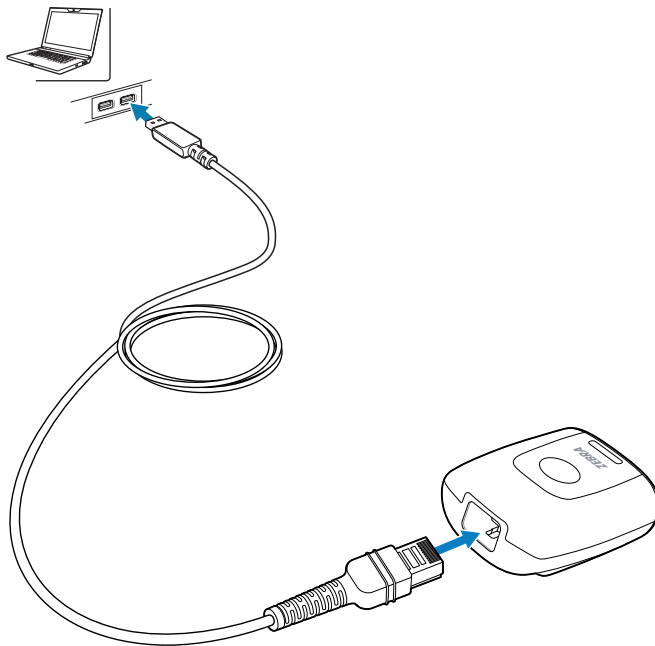

**NOTE:** When connecting via USB use the shielded connector cable (for example, p/n CBA-U21-S07ZAR). Refer to Solution Pathways for guidance about cables.

The scanner connects to USB-capable hosts including:

- TGCS (IBM) terminals

- Apple™ desktop and notebooks
- Other network computers that support more than one keyboard

The following operating systems support the scanner through USB:

- Windows® XP, 7, 8, 10
- MacOS 8.5 - MacOS 10.6
- TGCS (IBM) 4690/TCx Sky OS
- Linux

The scanner also interfaces with other USB hosts that support USB Human Interface Devices (HID).

## Connecting a USB Interface

You can connect a device by a USB interface cable.



**NOTE:** Interface cables vary depending on configuration. Any connectors illustrated are examples only. While connectors might be different than those illustrated, the steps to connect the scanner are the same.

1. Connect the modular connector of the USB interface cable to the cable interface port on the scanner.
2. Plug the series A connector in the USB host or hub.
3. The scanner automatically detects the host and uses the default USB device type. If the default (\*) does not meet your requirements, select another USB device type by scanning the appropriate barcode from [USB Device Type](#) on page 92.
4. On first installation when using Windows, the software may prompt to select or install the Human Interface Device driver. To install this driver, provided by Windows, click Next at all choices and click Finished on the last choice. The scanner powers up during this installation.
5. To modify any other parameter options, scan the appropriate barcodes in this section.

If problems occur with the system, see [Troubleshooting](#) on page 66.

## USB Parameter Defaults

The following table lists defaults for USB host parameters. You can change default values in one of two ways:

- Scan the appropriate barcodes in this section. The new value replaces the standard default value in memory. To recall default parameter values, see [Default Parameters](#) on page 128.
- Configure the scanner using the 123Scan configuration program. See [123Scan and Software Tools](#).

**Table 17** USB Interface Parameter Defaults

Parameter	Default
USB Host Parameters	
<a href="#">USB Device Type</a>	USB HID Keyboard
<a href="#">Symbol Native API (SNAPI) Status Handshaking</a>	Enable
<a href="#">USB Keystroke Delay</a>	No Delay

**Table 17** USB Interface Parameter Defaults (Continued)

Parameter	Default
USB Caps Lock Override	Do Not Override Caps Lock Key (Disable)
USB Barcodes with Unknown Characters	Send
USB Convert Unknown to Code 39	Disable
USB Fast HID	Enable
USB Polling Interval	3 msec
Keypad Emulation	Enable
Quick Keypad Emulation	Enable
Keypad Emulation with Leading Zero	Enable
USB Keyboard FN1 Substitution	Disable
Function Key Mapping	Disable
Simulated Caps Lock	Disable
Convert Case	No Case Conversion
USB Static CDC	Enable
CDC Beep on	Enable
USB CDC Host Variant	Standard
TGCS (IBM) USB Beep Directive	Enable
TGCS (IBM) USB Barcode Configuration Directive	Disable
TGCS (IBM) USB Specification Version	2.2

## USB Host Parameters

The following section provides USB Host Parameters.

### USB Device Type

Scan one of the following barcodes to select the USB device type.

To select a country keyboard type for the USB HID Keyboard host, see [Country Codes](#).

- When changing USB device types, the scanner resets and issues the standard startup beep sequences.
- When connecting two scanners to a host, IBM does not allow selecting two of the same device type. If you require two connections, select an IBM Table-top USB for one scanner and an IBM Hand-held USB for the second scanner.
- Select OPOS (IBM Hand-held with Full Disable) to completely shut off the scanner when an IBM register issues a Scan Disable command, including aim, illumination, decoding, and data transmission.

## USB Interface

- Before selecting USB CDC Host, ensure your host OS has a USB CDC driver installed. For reference, Windows 10 includes a native (built-in) USB CDC driver. To recover a scanner stalled (non-functional) in USB CDC mode:
  - Install a USB CDC Driver
- Select USB HID POS to communicate over a USB cable with Microsoft's Universal Windows Platform (UWP) applications running on Windows 10 devices.



\*USB HID Keyboard



IBM Table-top USB



IBM Hand-held USB



OPOS (IBM Hand-held with Full Disable)



USB CDC Host



SSI over USB CDC



Symbol Native API (SNAPI) with Imaging Interface



Symbol Native API (SNAPI) without Imaging Interface



USB HID POS (Windows 10 devices only)

## Symbol Native API (SNAPI) Status Handshaking

After selecting a SNAPI interface as the USB device type, select an option to enable or disable status handshaking.

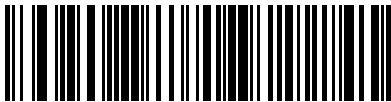

\*Enable SNAPI Status Handshaking



Disable SNAPI Status Handshaking

## USB Keystroke Delay

This parameter sets the delay, in milliseconds, between emulated keystrokes. Select a longer delay for hosts that require slower data transmission.



\*No Delay



Medium Delay (20 msec)

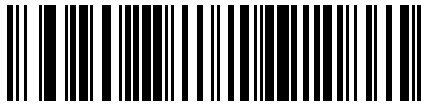

Long Delay (40 msec)

## USB Caps Lock Override

This option applies only to the USB HID Keyboard device. Select Override Caps Lock Key to preserve the case of the data regardless of the state of the Caps Lock key. This setting is always enabled for the Japanese Windows (ASCII) keyboard type and cannot be disabled.

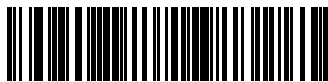

Override Caps Lock Key (Enable)

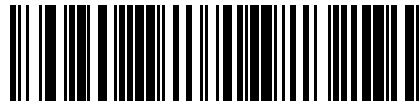

\*Do Not Override Caps Lock Key (Disable)

## USB Barcodes with Unknown Characters

This option applies only to the USB HID Keyboard and IBM devices. Unknown characters are characters the host does not recognize. Select Send Barcodes With Unknown Characters to send all barcode data except for unknown characters. The scanner issues no error beeps.

Select Do Not Send Barcodes With Unknown Characters for IBM devices to prevent sending barcodes containing at least one unknown character to the host, or for USB HID Keyboard devices to send the barcode characters up to the unknown character. The scanner issues an error beep.



\*Send Barcodes with Unknown Characters

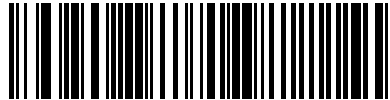

Do Not Send Barcodes with Unknown Characters

### USB Convert Unknown to Code 39

This option applies only to the IBM hand-held, IBM table-top, and OPOS devices. Select an option to enable or disable converting unknown barcode type data to Code 39.

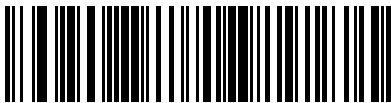

Enable Convert Unknown to Code 39

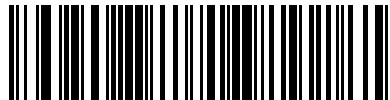

\*Disable Convert Unknown to Code 39

### USB Fast HID

Select Enable USB Fast HID to transmit USB HID data at a faster rate.



**NOTE:** Disable this if there are problems with transmission.





\*Enable USB Fast HID

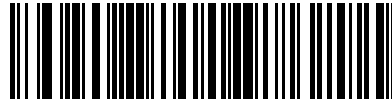

Disable USB Fast HID

## USB Polling Interval

Select an option to set the polling interval, which is the rate at which data transmits between the scanner and host computer. A lower number indicates a faster data rate.



**NOTE:** When changing the USB polling interval, the scanner restarts and issues a power-up beep sequence.



**IMPORTANT:** Ensure the host supports the selected data rate.



1 msec

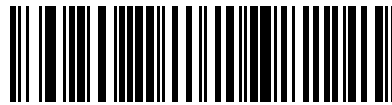

2 msec



\*3 msec



4 msec



5 msec



6 msec

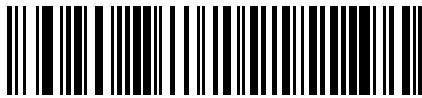

7 msec



8 msec



9 msec



10 msec

## Keypad Emulation

Select Enable Keypad Emulation to send all characters as ASCII sequences over the numeric keypad. For example, ASCII A transmits as “ALT make” 0 6 5 “ALT Break”.



**NOTE:** If your keyboard type is not listed in the country code list (see [Country Codes](#)), disable [Quick Keypad Emulation](#) and enable Keypad Emulation.



\*Enable Keypad Emulation

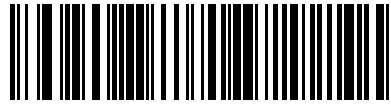

Disable Keypad Emulation

## USB Quick Keypad Emulation

Enable Quick Keypad Emulation for a quick method of emulation using the numeric keypad where ASCII sequences are only sent for ASCII characters not found on the keyboard.



**NOTE:** Quick Keypad Emulation only applies to the USB HID Keyboard device when Keypad Emulation is enabled.

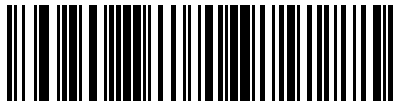

\*Enable Quick Keypad Emulation

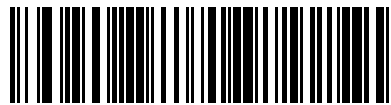

Disable Quick Keypad Emulation

## Keypad Emulation with Leading Zero

Select Enable Keypad Emulation with Leading Zero to send character sequences sent over the numeric keypad as ISO characters which have a leading zero. For example, ASCII A transmits as “ALT MAKE” 0 0 6 5 “ALT BREAK”.



**NOTE:** This parameter only applies if [Emulate Keypad](#) is enabled.



\*Enable Keypad Emulation with Leading Zero

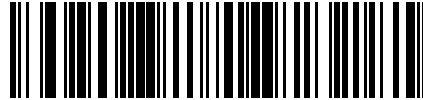

Disable Keypad Emulation with Leading Zero

## USB Keyboard FN1 Substitution

This option applies code 128 and ISBT 128 to the USB HID Keyboard device. Scan Enable USB Keyboard FN1 Substitution to replace any FN1 character in a GS1 128 barcode with a user-selected Key Category and value.

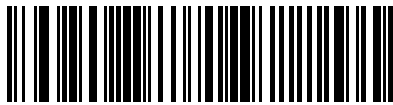

Enable USB Keyboard FN1 Substitution



\*Disable USB Keyboard FN1 Substitution

## USB Function Key Mapping

ASCII values under 32 are normally sent as a control-key sequence (see [ASCII Character Sets](#) on page 334). Select Enable Function Key Mapping to send the keys in bold instead of the standard key mapping. Table entries that do not have a bold equivalent remain the same regardless of whether you enable this parameter.

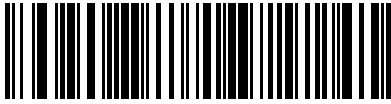

Enable Function Key Mapping

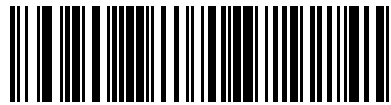

\*Disable Function Key Mapping

## USB Simulated Caps Lock

Select Enable Simulated Caps Lock to invert upper and lower case characters on the barcode as if the Caps Lock state is enabled on the keyboard. This inversion occurs regardless of the keyboard's Caps Lock state.



**NOTE:** Simulated Caps Lock applies to ASCII characters only. Do not enable this if [Caps Lock Override](#) is enabled.



Enable Simulated Caps Lock

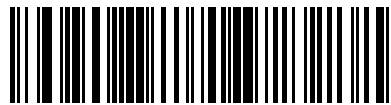

\*Disable Simulated Caps Lock

## USB Convert Case

Use this parameter to convert all of the barcode data to the selected case.



**NOTE:** Convert Case applies to ASCII characters only.

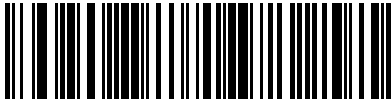

\*No Case Conversion

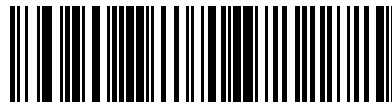

Convert All to Upper Case

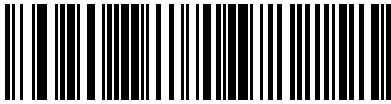

Convert All to Lower Case

## USB Static CDC

### Parameter # 670

You can connect devices to the same COM port or different COM ports.

When disabled, each device connected consumes another COM port (first device = COM1, second device = COM2, third device = COM3, etc.)

When enabled, each device connects to the same COM port.



\*Enable USB Static CDC (1)

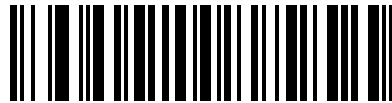

Disable USB Static CDC (0)

## CDC Beep on <BEL>

### Parameter # 150

If you enable this parameter, the scanner issues a beep when it detects a <BEL> character in USB CDC communications. <BEL> indicates an illegal entry or other important event.



\*Enable CDC Beep on <BEL>

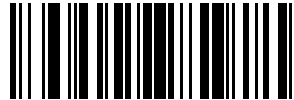

Disable CDC Beep on <BEL>

## USB CDC Host Variant

### Parameter # 1713

When USB Device Type is set to USB CDC Host, the CDC Host Variant selects which type of CDC variant is used. The default USB CDC host variant is Standard CDC Host Mode.

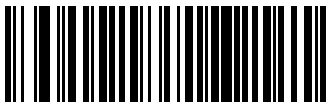

\*Standard USB CDC (0)



SITA USB CDC (1)

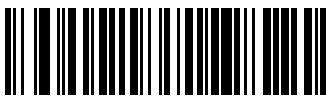

NCR USB CDC (9)



Datalogic USB CDC (10)

## TGCS (IBM) USB Beep Directive

The host can send a beeper configuration request to the scanner. Scan Ignore Beep Directive to prevent the scanner from processing the host request. All directives are still acknowledged to the USB host as if they were processed.



Honor Beep Directive



\*Ignore Beep Directive

## TGCS (IBM) Ignore Type Directive

The host can enable and disable code types. Scan Ignore Barcode Configuration Directive to prevent the scanner from processing the host request. All directives are still acknowledged to the USB host as if they were processed.



Honor Barcode Configuration Directive



\*Ignore Barcode Configuration Directive

## TGCS (IBM) USB Specification Version

### Parameter # 1729

You can specify code types as unknown or specify the code types with an appropriate IBM identifier.

Select IBM Specification Level (Original) to send the following code types as Unknown:

- Data Matrix
- GS1 Data Matrix
- QR Code
- GS1 QR
- MicroQR Code
- Aztec



Select IBM Specification Level Version 2.2 to send the code types with the appropriate IBM identifiers.



IBM Specification Level (Original)



\*IBM Specification Level Version 2.2 or higher

### USB ASCII Character Sets

See [ASCII Character Sets](#) for the following information:

- [ASCII Character Sets](#)
- [ALT Key Character Set](#)
- [GUI Key Character Set](#)
- [F Key Character Set](#)

# RS-232 Interface

You can set up a scanner with an RS-232 host. The scanner uses the RS-232 interface to connect to point-of-sale devices, host computers, or other devices with an available RS-232 port (for example, com port).

The scanner ships with the settings shown in [RS-232 Parameter Defaults](#) on page 108. If the default values suit requirements, programming is not necessary.

If your host does not appear in [RS-232 Host-Specific Parameter Settings](#) on page 109, refer to the documentation for the host device to set communication parameters to match the host.



**NOTE:** The scanner uses TTL RS-232 signal levels, which interface with most system architectures. For system architectures requiring RS-232C signal levels, Zebra offers different cables providing TTL-to-RS-232C conversion. Contact support for more information.

## Connecting an RS-232 Interface

Connect the scanner directly to the host computer.

**Figure 9** RS-232 Connection

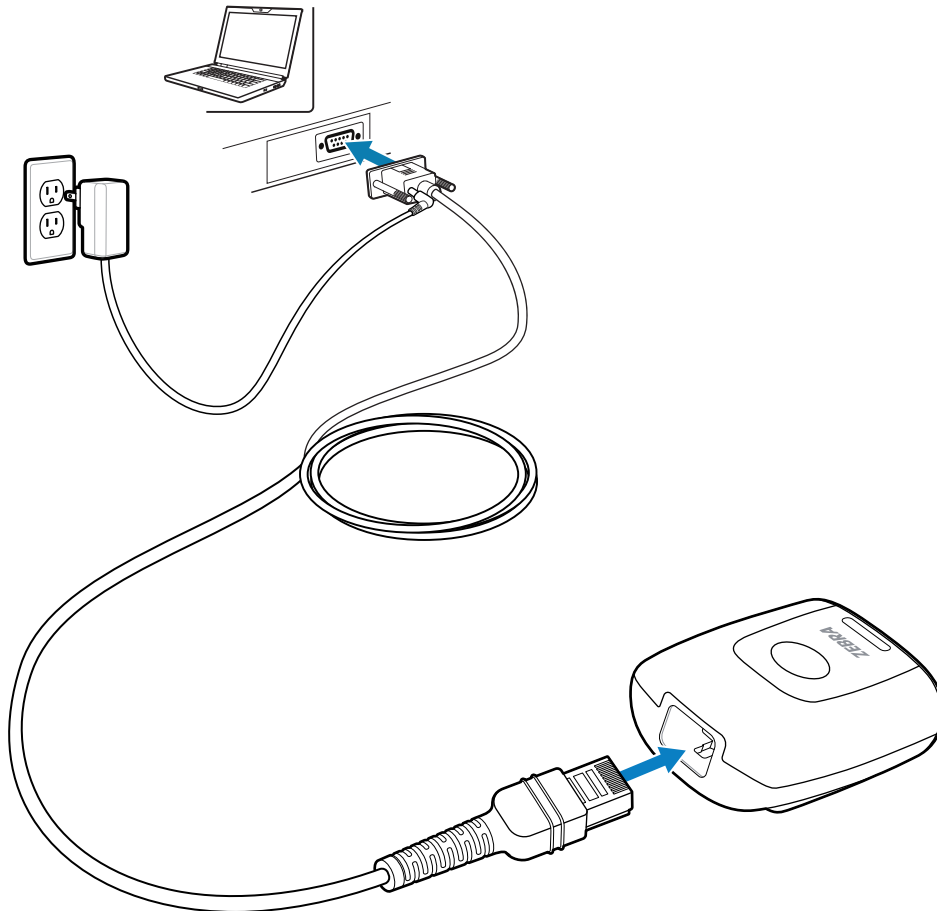

**NOTE:** Interface cables vary depending on configuration. The connectors can be different than those illustrated, but the steps to connect the scanner are the same.

1. Attach the modular connector of the RS-232 interface cable to the cable interface port on the scanner.
2. Connect the other end of the RS-232 interface cable to the serial port on the host.
3. If required, connect the power supply to the serial connector end of the RS-232 interface cable. Plug the power supply into an appropriate outlet.
4. The scanner automatically detects the host interface type and uses the default setting. If the default (\*) does not meet your requirements, select another RS-232 host type by scanning the appropriate barcode from [RS-232 Host Types](#).
5. To modify any other parameter options, scan the appropriate barcodes in this section.

If problems occur with the system, see [Troubleshooting](#).

## Serial Interface Cable Connection

When connecting via RS-232, identify the type of host system to determine the cable needed. If you are unsure what host system you use, contact the local Zebra representative.

### TTL Level Compatible RS-232 Host Systems

If using a PC, laptop, or POS terminal, the host system most likely has an RS-232 port which is compatible with TTL levels. In this case, use the standard 5V RS-232 cable.

## RS-232 Parameter Defaults

The following table lists defaults for RS-232 host parameters. You can change the default values in one of two ways:

- Scan the appropriate barcodes in this section. The new value replaces the standard default value in memory. To recall default parameter values, see [Default Parameters](#).
- Configure the scanner using the 123Scan configuration program. See [123Scan and Software Tools](#).

**Table 18** RS-232 Interface Parameter Defaults

Parameter	Default
RS-232 Host Parameters	
<a href="#">RS-232 Host Types</a>	Standard
<a href="#">RS-232 Baud Rate</a>	9600
<a href="#">Parity</a>	None
<a href="#">Stop Bits</a>	1 Stop Bit
<a href="#">Data Bits</a>	8-bit
<a href="#">Check Receive Errors</a>	Enable
<a href="#">Hardware Handshaking</a>	None
<a href="#">Software Handshaking</a>	None
<a href="#">Host Serial Response Timeout</a>	2 Seconds
<a href="#">RTS Line State</a>	Low RTS
<a href="#">Beep on &lt;BEL&gt;</a>	Disable
<a href="#">Intercharacter Delay</a>	0 msec
<a href="#">Nixdorf Beep/LED Options</a>	Normal Operation
<a href="#">Barcodes with Unknown Characters</a>	Send Barcode With Unknown Characters
<a href="#">Datalogic Host Format</a>	Enable
<a href="#">Datalogic Supported Commands</a>	Disable
<a href="#">NCR Enable/Disable Alternate Beep Volume for Not on File Event</a>	Disable
<a href="#">NCR Not on File Beeper Volume</a>	Low Volume
<a href="#">NCR Use Prefix</a>	Enable

**Table 18** RS-232 Interface Parameter Defaults (Continued)

Parameter	Default
NCR Prefix	1002 (STX)
NCR Suffix	1003 (ETX)
NCR Use Block Check Character	Enable
NCR 2D Label-ID Mode	NCR Mode

## RS-232 Host-Specific Parameter Settings

Some RS-232 hosts use their own parameter default settings.

You can select standard, ICL, Fujitsu, Wincor-Nixdorf Mode A or B, OPOS/JPOS, Olivetti, Omron, Common Use Terminal Equipment (CUTE-LP/LG barcode readers), NCR, or Datalogic and set the appropriate default.

**Table 19** RS-232 Host-Specific Settings

Parameter	ICL	Fujitsu	Wincor-Nixdorf Mode A	Wincor-Nixdorf Mode B/ OPOS/JPOS
Baud Rate	9600	9600	9600	9600
Parity	Even	None	Odd	Odd
Stop Bits	One	One	One	One
Data Bits	8-bit	8-bit	8-bit	8-bit
Hardware Handshaking	RTS/CTS Option 3	None	RTS/CTS Option 3	RTS/CTS Option 3
Software Handshaking	None	None	None	None
Serial Response Timeout	9.9 Seconds	2 Seconds	None	None
RTS Line State	High	Low	Low	Low = No data to send
Beep On <BEL>	Disable	Disable	Disable	Disable
Transmit Code ID	Yes	Yes	Yes	Yes
Data Transmission Format	Data/Suffix	Data/Suffix	Data/Suffix	Data/Suffix
Prefix	None	None	None	None
Suffix	CR (1013)	CR (1013)	CR (1013)	CR (1013)
In the Wincor-Nixdorf Mode A/B, when CTS is low, scanning is disabled and when CTS is high, scanning is enabled. If you scan Wincor-Nixdorf RS-232 Mode A/B without connecting the scanner to the proper host, it may appear unable to scan. In this case, scan a different RS-232 host type within 5 seconds of cycling power to the scanner.				

**Table 20** RS-232 Host-Specific Settings

Parameter	Olivetti	Omron	CUTE	NCR	Datalogic
Baud Rate	9600	9600	9600	9600	9600
Parity	Even	None	Even	Odd	Odd
Stop Bits	One	One	One	One	One
Data Bits	7-bit	8-bit	7-bit	7-bit	7-bit
Hardware Handshaking	None	None	None	None	None
Software Handshaking	ACK/NAK	None	None	None	None
Serial Response Timeout	9.9 Seconds	9.9 Seconds	9.9 Seconds	9.9 Seconds	9.9 Seconds
RTS Line State	Low	High	High	High	High
Beep On <BEL>	Disable	Disable	Disable	Disable	Enable
Transmit Code ID	Yes	Yes	Yes	Yes	Yes
Data Transmission Format	Prefix/Data/Suffix	Data/Suffix	Prefix/Data/Suffix	Prefix/Suffix*	Data/Suffix
Prefix	STX (1003)	None	STX (1002)	STX*	None
Suffix	ETX (1002)	CR (1013)	CR (1013) ETX (1003)	ETX*	CR (1013)

The CUTE host disables all parameter scanning, including Set Defaults. If you inadvertently select CUTE, scan [Enable Parameter Barcode Scanning](#), and then change the host selection.

## RS-232 Host-Specific Code ID Characters

RS-232 hosts have code ID characters that are transmitted automatically.

RS-232 hosts ICL, Fujitsu, Nixdorf Mode A or B, OPOS/JPOS, Olivetti, Omron, CUTE, NCR, or Datalogic transmit code ID characters. These characters are not programmable and are separate from the Transmit Code ID feature. Do not enable the Transmit Code ID feature for these hosts.

**Table 21** RS-232 Host-Specific Code ID Characters

Code Type	ICL	Fujitsu	Wincor-Nixdorf Mode A	Wincor-Nixdorf Mode B/OPOS/JPOS
UPC-A	A	A	A	A
UPC-E	E	E	C	C
EAN-8/JAN-8	FF	FF	B	B
EAN-13/JAN-13	F	F	A	A
Bookland EAN	F	F	A	A
Code 128	L <len>	None	K	K
GS1-128	L <len>	None	P	P
Code 39	C <len>	None	M	M

**Table 21** RS-232 Host-Specific Code ID Characters (Continued)

Code Type	ICL	Fujitsu	Wincor-Nixdorf Mode A	Wincor-Nixdorf Mode B/OPOS/JPOS
Code 39 Full ASCII	None	None	M	M
Trioptic	None	None	None	None
Code 32	None	None	None	None
Code 93	None	None	L	L
I 2 of 5	I <len>	None	I	I
D 2 of 5	H <len>	None	H	H
IATA	H<len>	None	H	H
Codabar	N <len>	None	N	N
MSI	None	None	O	O
GS1 DataBar Variants	None	None	E	E
PDF417	None	None	Q	Q
MicroPDF417	None	None	S	S
Data Matrix	None	None	R	R
GS1 Data Matrix	None	None	W	W
Maxicode	None	None	T	T
QR Code	None	None	U	U
GS1 QR	None	None	X	X
Aztec/Aztec Rune	None	None	V	V

**Table 22** RS-232 Host-Specific Code ID Characters

Code Type	Olivetti	Omron	CUTE	NCR	Datalogic
UPC-A	A	A	A	A	A
UPC-E	C	E	None	E	E
EAN-8/JAN-8	B	FF	None	FF	FF
EAN-13/JAN-13	A	F	A	F	F
Code 128	K <len>	L <len>	5	B3	#
Code 39	M <len>	C <len>	3	B1	*
Code 39 Full ASCII	None	None	3	None	None
Trioptic	None	None	None	None	\$T
I 2 of 5	I <len>	I <len>	1	B2	i
D 2 of 5	H <len>	H <len>	2	None	None
IATA	H<len>	H<len>	2	None	IA

**Table 22** RS-232 Host-Specific Code ID Characters (Continued)

Code Type	Olivetti	Omron	CUTE	NCR	Datalogic
Codabar	N <len>	N <len>	None	N	%
MSI	O <len>	None	None	None	@
GS1 DataBar Variants	None	None	None	je0	DataBar-R4 DataBar Limited: RL DataBar Expanded: RX
PDF417	None	None	6	jL2*	P
MicroPDF417	None	None	6	jL2*	mP
Data Matrix	None	None	4	jd0*	Dm
QR Code	None	None	7	jQ0	QR
Aztec/Aztec Rune	None	None	8	jz0	Az

## RS-232 Host Types

Select an RS-232 host interface using one of the following options.

Notes on using RS-232 host types:

- For a list of supported scanner functionality by communication protocol, see [Communication Protocol Functionality](#).
- Scanning Standard RS-232 activates the RS-232 driver, but does not change port settings (for example, parity, data bits, handshaking). Selecting another RS-232 host type barcode changes these settings.
- The CUTE host disables all parameter scanning, including Set Defaults. If you inadvertently select CUTE, scan [Enable Parameter Barcode Scanning](#), and then change the host selection.

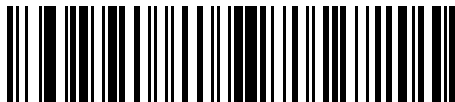

\*Standard RS-232

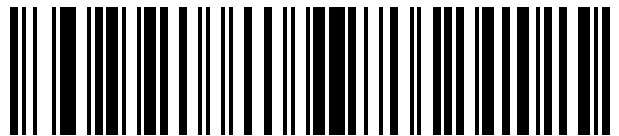

ICL RS-232

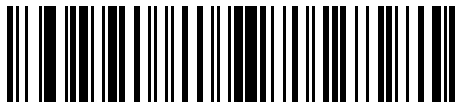

Nixdorf RS-232 Mode A





Olivetti ORS4500



Nixdorf RS-232 Mode B



Omron



OPOS/JPOS

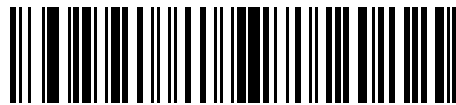

Fujitsu RS-232



CUTE



Datalogic Variant

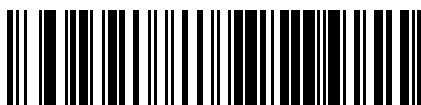

NCR

## RS-232 Baud Rate

The RS-232 baud rate is the number of bits of data transmitted per second.

Select an option to set the scanner's baud rate to match the baud rate setting of the host device. Otherwise, data may not reach the host device or may reach it in distorted form.

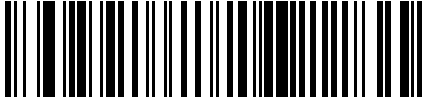

\*Baud Rate 9600



Baud Rate 19,200

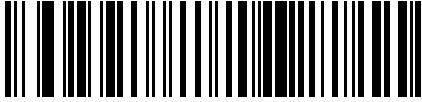

Baud Rate 38,400

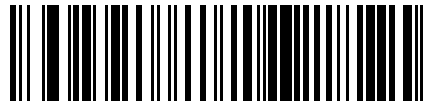

Baud Rate 57,600



Baud Rate 115,200

## RS-232 Parity

A parity check bit is the most significant bit of each ASCII coded character. Choose an option to select the parity type according to host device requirements.

- Odd - This sets the parity bit value to 0 or 1, based on data, to ensure that the coded character contains an odd number of 1 bits.
- Even - This sets the parity bit value to 0 or 1, based on data, to ensure that the coded character contains an even number of 1 bits.
- None - No parity bit is required.

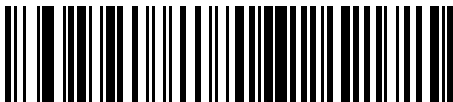

Odd

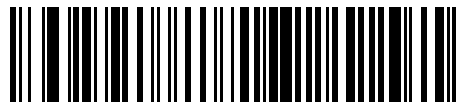

Even

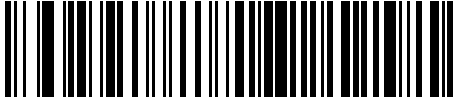

\*None

## RS-232 Stop Bits

The stop bit(s) at the end of each transmitted character marks the end of transmission of one character and prepares the receiving device for the next character in the serial data stream. Select an option to set the number of stop bits (one or two) based on the number the receiving host can accommodate.

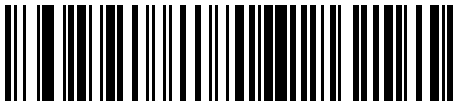

\*1 Stop Bit

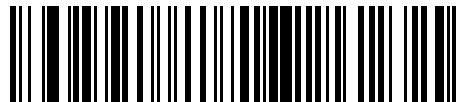

2 Stop Bits

## Data Bits

This parameter allows the scanner to interface with devices requiring a 7-bit or 8-bit ASCII protocol.

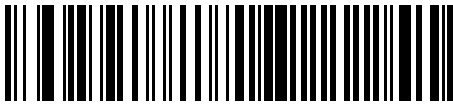

7-bit

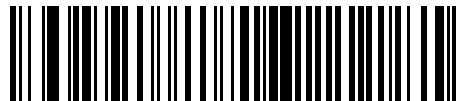

\*8-bit

## Check Receive Errors

This parameter determines whether to check the parity, framing, and overrun of received characters.



**NOTE:** The parity value of received characters is verified against the value set for [Parity](#).

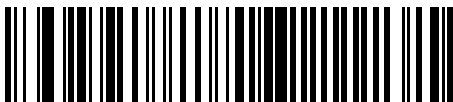

\*Check For Received Errors



Do Not Check For Received Errors

## Hardware Handshaking

The data interface consists of an RS-232 port designed to operate either with or without the hardware handshaking lines Request to Send (RTS) and Clear to Send (CTS).

If hardware handshaking and software handshaking are both enabled, hardware handshaking takes precedence.



**NOTE:** The DTR signal is jumpered to the active state.

You can choose one of the following options:

### None

This disables hardware handshaking and transmits scan data as it becomes available.

### Standard RTS/CTS

This sets standard RTS/CTS hardware handshaking and transmits scanned data. The scanner reads the CTS line for activity according to the following sequence:

- If the CTS line is de-asserted, the scanner asserts the RTS line and waits up to [Host Serial Response Timeout](#) for the host to assert CTS, and then transmits data when asserted. If, after the timeout, the CTS line is not asserted, the scanner sounds a transmit error and discards the data.
- If CTS is asserted, the scanner waits up to [Host Serial Response Timeout](#) for the host to de-assert CTS. If after this timeout the CTS line is still asserted, the scanner sounds a transmit error and discards the scanned data.
- The scanner de-asserts RTS after sending the last character of data.
- The host negates CTS. The scanner checks for a de-asserted CTS upon the next data transmission.



**NOTE:** During data transmission, if CTS is deasserted for more than 50 ms between characters, the scanner sounds a transmit error and discards the data. The data must be re-scanned.

### RTS/CTS Option 1

The scanner asserts RTS before transmitting and ignores the state of CTS. The scanner de-asserts RTS when transmission completes.

### RTS/CTS Option 2

RTS is always high or low (user-programmed logic level). However, the scanner waits for the host to assert CTS before transmitting data. If CTS is not asserted within the [Host Serial Response Timeout](#), the scanner sounds a transmit error and discards the data. During data transmission, if CTS is deasserted for more than 50 ms between characters, the scanner sounds a transmit error and discards the data.

## RTS/CTS Option 3

This transmits scanned data according to the following sequence:

- The scanner asserts RTS before data transmission, regardless of the state of CTS.
- The scanner waits up to the [Host Serial Response Timeout](#) for the host to assert CTS, and then transmits data when asserted. If, after the timeout, the CTS line is not asserted, the scanner sounds a transmit error and discards the data.
- The scanner de-asserts RTS after sending the last character of data.
- The host negates CTS. The scanner checks for a de-asserted CTS upon the next data transmission.



**NOTE:** During data transmission, if CTS is deasserted for more than 50 ms between characters, the scanner sounds a transmit error and discards the data. The data must be re-scanned.

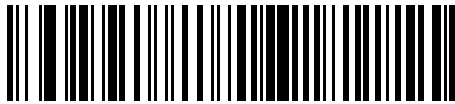

\*None

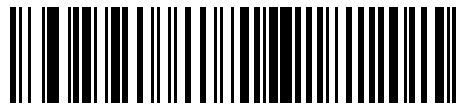

Standard RTS/CTS

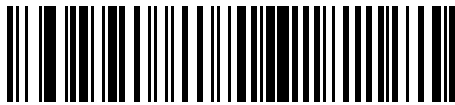

RTS/CTS Option 1

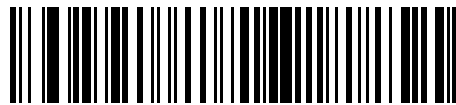

RTS/CTS Option 2

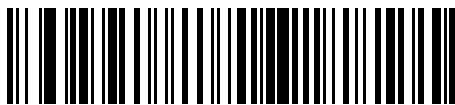

RTS/CTS Option 3

## Software Handshaking

This parameter offers control of data transmission in addition to, or instead of, that offered by hardware handshaking. If software handshaking and hardware handshaking are both enabled, hardware handshaking takes precedence.

- None - This transmits data immediately. The scanner expects no response from the host.
- ACK/NAK - After transmitting data, the scanner waits for an ACK or NAK response from the host. If it receives a NAK, the scanner transmits the data again and waits for an ACK or NAK. After three unsuccessful attempts to send data after receiving NAKs, the scanner sounds a transmit error and

discards the data. The scanner waits up to the programmable [Host Serial Response Timeout](#) to receive an ACK or NAK. If the scanner does not get a response in this time, it sounds a transmit error and discards the data. There are no reattempts.

- ENQ - The scanner waits for an ENQ character from the host before transmitting data. If it does not receive an ENQ within the [Host Serial Response Timeout](#), the scanner sounds a transmit error and discards the data. The host must transmit an ENQ character at least every [Host Serial Response Timeout](#) to prevent transmission errors.
- ACK/NAK with ENQ - This combines the two previous options. An additional ENQ is not required to re-transmit data due to a NAK from the host.
- XON/XOFF - An XOFF character stops data transmission until the scanner receives an XON character. There are two situations for XON/XOFF:
  - The scanner receives an XOFF before it has data to send. When the scanner has data, it waits up to the [Host Serial Response Timeout](#) for an XON character before transmitting. If it does not receive the XON within this time, the scanner sounds a transmit error and discards the data.
  - The scanner receives an XOFF during data transmission and stops transmission after sending the current byte. When the scanner receives an XON character, it sends the rest of the data. The scanner waits indefinitely for the XON.

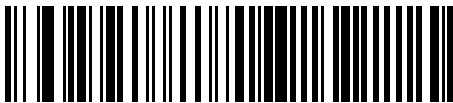

\*None

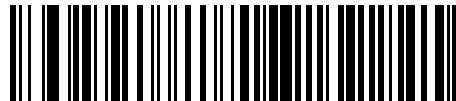

ACK/NAK

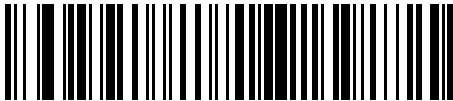

ENQ

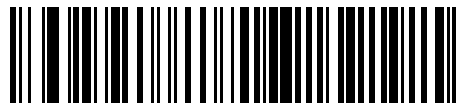

ACK/NAK with ENQ

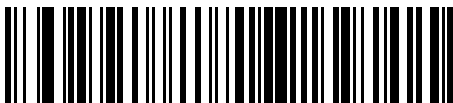

XON/XOFF

## RS-232 Host Serial Response Timeout

This parameter specifies how long the scanner waits for an ACK, NAK, or CTS before determining that a transmission error occurred. This only applies when in one of the ACK/NAK software handshaking modes, or RTS/CTS hardware handshaking mode.

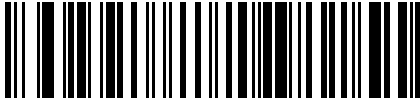

\*Minimum: 2 Seconds



Low: 2.5 Seconds



Medium: 5 Seconds

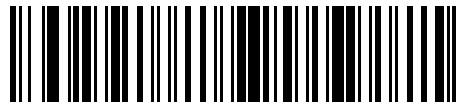

High: 7.5 Seconds

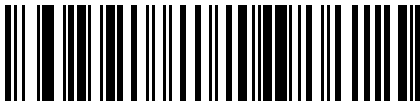

Maximum: 9.9 Seconds

## RTS Line State

This parameter sets the idle state of the serial host RTS line to Low RTS or High RTS.

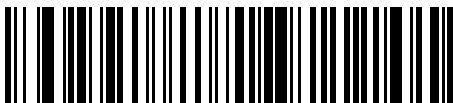

\*Host: Low RTS

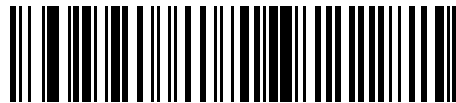

Host: High RTS

## Beep on <BEL>

This parameter sets whether the scanner issues a beep when it detects a <BEL> character on the RS-232 serial line. <BEL> indicates an illegal entry or another important event.

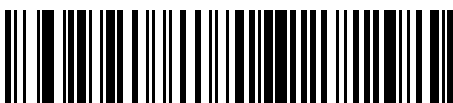

Beep On <BEL> Character (Enable)



\*Do Not Beep On <BEL> Character (Disable)

## Intercharacter Delay

This parameter specifies the intercharacter delay inserted between character transmissions.



\*Minimum: 0 msec

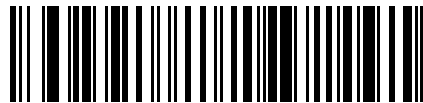

Low: 25 msec



Medium: 50 msec



High: 75 msec



Maximum: 99 msec

## Nixdorf Beep/LED Options

If you selected Nixdorf Mode B, scan one of the following barcodes to indicate when the scanner beeps and turns on its LED after a decode.

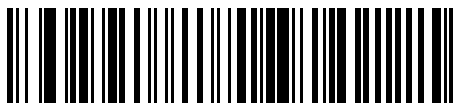

\*Normal Operation (Beep/LED Immediately After Decode)





Beep/LED After Transmission



Beep/LED After CTS Pulse

## RS-232 Barcodes with Unknown Characters

Unknown characters are characters the host does not recognize. Select Send Barcodes With Unknown Characters to send all barcode data except for unknown characters. The scanner issues no error beeps.

Select Do Not Send Barcodes With Unknown Characters to send barcode data up to the first unknown character. The scanner issues an error beep.

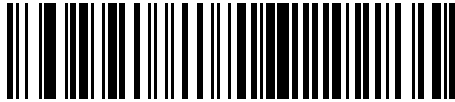

\*Send Barcodes With Unknown Characters

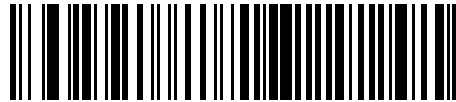

Do Not Send Barcodes With Unknown Characters

## Datalogic Host Format

### Parameter # 2253 (SSI # F8 08 CD)

When this parameter is enabled (default), the Datalogic host variant appends a code ID and a suffix value (CR) to the decoded data. When this parameter is disabled, only the decode data is transmitted. These commands are supported over RS232 or USB CDC.



\*Enable (1)



Disable (0)

## Datalogic Supported Commands

### Parameter # 2260 (SSI # F8 08 D4)

This parameter allows serial scan to enable or disable commands for a standard RS232 host.

- ‘E’ or ‘e’ = Enable Scanning
- ‘D’ or ‘d’ = Disable Scanning
- ‘R’ = Reset the scanner
- ‘F’ = Indicate to the scanner that Datalogic is not on file
- ‘B’ = Issue a good read beep
- 1 (Not an ASCII Character – This is a decimal number 1) = Force a good read beep
- 7 (Not an ASCII Character – This is a decimal number 7) = Force a good read beep

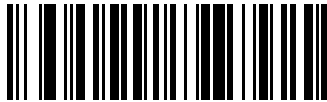

Enable (1)

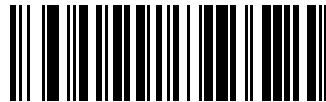

\*Disable (0)

## NCR Host Preferences

If you select NCR as an RS-232 Host Type, you can choose select parameters for communications.

### NCR Enable/Disable Alternate Beep Volume for Not on File Event

#### Parameter # 2384

Controls the ability to adjust beep volume for a not on file event. The default is disable.

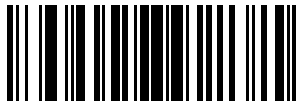

\*Disable

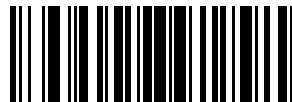

Enable

### NCR Not on File Beeper Volume

#### Parameter # 2383

Sets the beeper volume for not on file events to Low, Medium, or High. The default is Low Volume.



**NOTE:** [Enable / Disable Alternate Beep Volume for Not on File Event](#) must be enabled for this parameter to function.



\*Low Volume (02)



Medium Volume (02)



High Volume (00)

## NCR Use Prefix

### Parameter # 1238

You can enable or disable NCR using the prefix.

If you selected NCR from [RS-232 Host Types](#), use this parameter to enable or disable using the prefix for all communications.



\*Enable NCR Use Prefix (1)



Disable NCR Use Prefix (0)

## NCR Prefix

### Parameter # 1282

You can set the prefix character to use if you enabled NCR.

If you selected NCR from [RS-232 Host Types](#) and enabled [NCR Use Prefix](#), set the prefix character to use for all communications.

To do this, scan the following barcode, and then scan four numeric barcodes from [Numeric Barcodes](#) that correspond to the desired character in [NCR Use Prefix](#). The default is 1002 (STX).



NCR Prefix

## NCR Suffix

### Parameter # 1283

You can set the suffix (terminator) character to use if you enabled NCR.

If you selected NCR from [RS-232 Host Types](#), set the suffix (terminator) character to use for all communications.

To do this, scan the following barcode, and then scan four numeric barcodes from [Numeric Barcodes](#) that correspond to the desired character in [ASCII Character Sets](#). The default is 1003 (ETX).

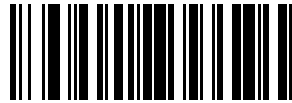

NCR Suffix

## NCR Use Block Check Character (BCC)

### Parameter # 1239

You can enable Block Check Character if you enabled NCR.

If you selected NCR from [RS-232 Host Types](#), use this parameter to enable or disable using the Block Check Character (after the Terminator byte) for all communications.

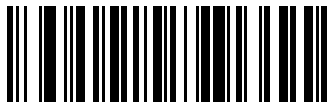

\*Enable NCR Use BCC (1)



Disable NCR Use BCC (0)

## NCR 2D Label-ID Mode

### Parameter # 1948

Select an NCR 2D Label-ID mode for the defined bar code prefix type.

- NCR Mode - Adds an NCR prefix to a bar code. This is the default.
- Legacy Mode - Adds an non-NCR prefix to a bar code.
- Suppress Mode - No prefix is added to a bar code.



\* NCR Mode (0)



Legacy Mode (1)



Suppress Mode (2)

## RS-232 ASCII Character Sets

You can refer to the ASCII Character Sets for prefix and suffix values.

See [ASCII Character Sets](#) for prefix/suffix values.

# User Preferences and Miscellaneous Options

You can program the scanner to perform various functions or activate different features. This section describes user preference features and provides programming barcodes for selecting these features.

The scanner ships with the settings shown in . If the default values suit requirements, programming is not necessary.

## Setting User Preference Parameters

To set feature values, scan a single barcode or a short barcode sequence. The settings are stored in non-volatile memory and are preserved even when the scanner powers down.



**NOTE:** Most computer monitors allow scanning barcodes directly on the screen. When scanning from the screen, be sure to set the document magnification to a level where you can see the barcode clearly, and bars and/or spaces do not merge.

If not using the default host, select the host type (see each host section for specific host information) after the power-up beeps sound. This is only necessary upon the first power-up when connected to a new host.

To return all features to default values, see [Default Parameters](#). Throughout the programming barcode menus, asterisks indicate (\*) default values.

## User Preference Scanning Sequence Examples

In most cases, scanning one barcode sets the parameter value.

Other parameters require scanning several barcodes. Relevant parameters contain descriptions for this procedure.

## User Preference Errors While Scanning

Unless otherwise specified, to correct an error during a scanning sequence, re-scan the correct parameter.

## User Preferences/Miscellaneous Options Parameter Defaults

The following table lists defaults for user preference and miscellaneous option parameters. Change these values in one of two ways:

- Scan the appropriate barcodes in this chapter. The new value replaces the standard default value in memory. To recall default parameter values, see [Default Parameters](#) on page 128.

- Configure the scanner using the 123Scan configuration program. See [123Scan and Software Tools](#) on page 50.



**NOTE:** Standard parameter defaults are available in each chapter of this guide.

**Table 23** User Preferences Parameter Defaults

Parameter	Parameter Number <sup>a</sup>	SSI Number <sup>b</sup>	Default
User Preferences			
Set Default Parameter	N/A	N/A	N/A
Parameter Barcode Scanning	236	ECh	Enable
Lock/Unlock Parameter Scanning	802	F2h 22h	Disable
Lock/Unlock Parameter Scanning	803	F2h 23h	Disable
Beep After Good Decode	56	38h	Enable
Beeper Volume	140	8Ch	High
Scan Tone	145	91h	Medium
Beeper Duration	628	F1h 74h	Medium
Suppress Power-Up Beeps	721	F1h D1h	Do Not Suppress
LED on Good Decode	744	F1h E8h	Enable
Low Power Mode	128	80h	Disable
Time Delay to Low Power Mode	146	92h	1 Hour
Trigger Mode	138	8Ah	Presentation Mode
Hand-held Decode Aiming Pattern	306	F0h 32h	Enable
Hands-free (Presentation) Decode Aiming Pattern	590	F1h 4Eh	Enable Hands-free (Presentation) Decode Aiming Pattern on PDF
Momentary Trigger Mode Timeout	2030	EDh	5 Seconds
Picklist Mode	402	F0h 92h	Disable Picklist Mode Always
Decode Session Timeout	136	88h	9.9 Seconds
Continuous Barcode Read	649	F1h 89h	Disable
Unique Barcode Reporting	723	F1h D3h	Enable
Hands-Free Decode Session Timeout	400	F0h 90h	15
Timeout Between Decodes, Same Symbol	137	89h	0.5 Seconds
Timeout Between Decodes, Different Symbols	144	90h	0.1 Seconds
Mobile Phone/Display Mode	716	F1h CCh	Enhance in Hands-Free Mode
Motion Detect Mode (Wakeup)	2377	F8 09 49	Object Detect
PDF Prioritization	719	F4h F1h CFh	Disable

**Table 23** User Preferences Parameter Defaults (Continued)

Parameter	Parameter Number <sup>a</sup>	SSI Number <sup>b</sup>	Default
PDF Prioritization Timeout	720	F1h D0h	200 ms
Presentation Mode Field of View	609	F1h 61h	Full
Mirrored Image	624	F1h 70h	Disable
Decoding Illumination	298	F0h 2Ah	Enable
Illumination Brightness	669	F1h 9Dh	High
Low Light Scene Detection	810	F2h 2Ah	Disable
Product ID (PID) Type	1281	F8h 05h 01h	Host Type Unique
Product ID (PID) Value	1725	F8h 06h BDh	0
Alternate Numeric Keypad Emulation	N/A	N/A	Enable
Miscellaneous Options			
Enter Key	N/A	N/A	N/A
Tab Key	N/A	N/A	N/A
Transmit Code ID Character	45	2Dh	None
Prefix Value	99, 105	63h, 69h	7013 <CR><LF>
Suffix 1 Value	98, 104	62h, 68h	7013 <CR><LF>
Suffix 2 Value	100, 106	64h, 6Ah	7013 <CR><LF>
Scan Data Transmission Format	235	EBh	Data As Is
FN1 Substitution Values	103, 109	67h, 6Dh	7013 <CR><LF>
Transmit "No Read" Message	94	5E	Disable
Unsolicited Heartbeat Interval	1118	F8h 04h 5Eh	Disable

<sup>a</sup> Parameter number decimal values are used for programming via RSM commands.

<sup>b</sup> SSI number hex values are used for programming via SSI commands.

## User Preferences

Set feature values by scanning the desired parameter values.

### Default Parameters

Scan one of the following barcodes to reset the scanner to its default settings.

- Restore Defaults resets all default parameters as follows:
  - If you configured custom default parameter values via the Write to Custom Defaults barcode, scanning the Restore Defaults barcode restores these custom values.
  - If you did not configure custom default parameter values, scanning the Restore Defaults barcode restores the factory default values. Default values are available at the beginning of each section.



- Set Factory Defaults clears all custom default values and sets the factory default values. Default values are available at the beginning of each section.



Restore Defaults

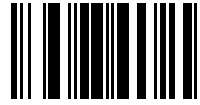

Set Factory Defaults

### Parameter Barcode Scanning

#### Parameter # 236 (SSI # ECh)

This parameter selects whether to enable or disable the decoding of parameter barcodes, including the **Set Defaults** barcodes.



\*Enable Parameter Barcode Scanning (1)



Disable Parameter Barcode Scanning (0)

### Lock/Unlock Parameter Scanning

#### Lock Parameter # 802 (SSI # F2h 22h)

#### Unlock Parameter # 803 (SSI # F2h 23h)

This feature locks parameter settings with a 4-digit code to prevent the user from changing parameter values by scanning parameter barcodes. This provides an added level of security not offered via **Disable Parameter Barcode Scanning**.

After locking parameter settings, only the **Unlock** parameter barcode is accepted with the correct code.



**NOTE:** [Parameter Barcode Scanning](#) must be enabled in order to scan the **Lock** parameter barcode. Once parameter scanning is locked, using the **Enable** or **Disable Parameter Barcode Scanning** parameter option results in a parameter error beep.

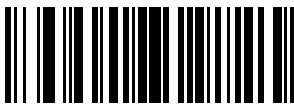

Lock

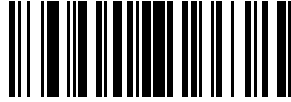

Unlock

## Locking Parameter Scanning

1. Scan the Lock barcode.
2. Scan four barcodes from [Numeric Barcodes](#) that represent the desired code. Enter leading zeros for numbers below 1000, e.g., to program a code of 29, enter 0, 0, 2, 9. A lock beep sounds (two long high beeps) in addition to the parameter entry beep.

## Unlocking Parameter Scanning

1. Scan the UnLock barcode.
2. Scan four barcodes from [Numeric Barcodes](#) that represents the correct code. An unlock beep sounds (two long low beeps) in addition to the parameter entry beep. Entering an incorrect code results in a parameter error beep.

## Locking/Unlocking via the Host Interface

Parameter scanning can also be locked or unlocked using a host interface such as SSI or USB SNAPI. To lock parameter scanning using the host interface, store a 4-digit code within the range of 1-9999 in the Lock parameter. Values outside this range are ignored. To unlock parameter scanning, store this code in the Unlock parameter. To persist the lock/unlock status through a power cycle, make this parameter value permanent.



**NOTE:** Parameter values can be changed via host interface commands even when parameter scanning is locked.

## Beep After Good Decode

### Parameter # 56 (SSI # 38h)

This parameter selects whether or not the scanner beeps after a good decode. If you select **Disable Beep After Good Decode**, the beeper still operates during parameter menu scanning and to indicate error conditions.



\*Enable Beep After Good Decode (1)

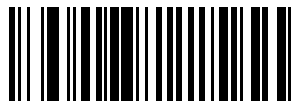

Disable Beep After Good Decode (0)

## Beeper Volume

### Parameter # 140 (SSI # 8Ch)

This parameter selects a beeper volume.

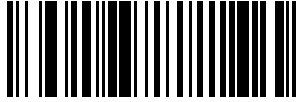

Low Volume (2)



Medium Volume (1)

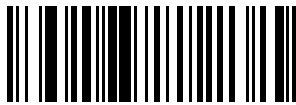

\*High Volume (0)

## Scan Tone

### Parameter # 145 (SSI # 91h)

Use this parameter to select a scan tone. Select one scan tone from the special tones or from the standard tones. Use the Disable Tone option to disable all tones.

#### Standard Tones

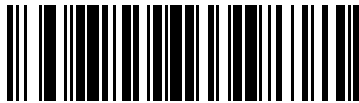

Disable Tone (3)

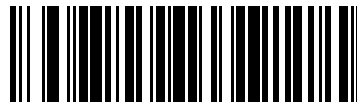

Low Tone (2)



\*Medium Tone (1)

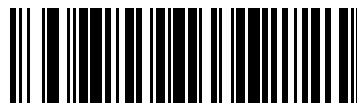

High Tone (0)



Medium to High Tone (2-tone) (4)

**Special Tones**



Wood Block / Tone 1 (6)



Pulse / Tone 2 (7)

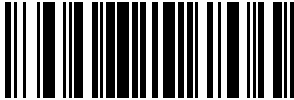

Chime / Tone 3 (8)

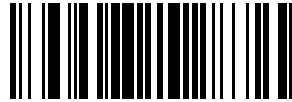

Zap / Tone 4 (9)

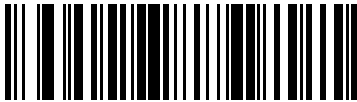

Triple Beep / Tone 5 (10)

**Beeper Duration**

**Parameter # 628 (SSI # F1h 74h)**

This parameter selects the duration for the good decode beep.

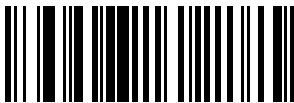

Short Duration (0)



\*Medium Duration (1)



Long Duration (2)

## Suppress Power Up Beeps

### Parameter # 721 (SSI # F1h D1h)

This parameter selects whether or not to suppress the scanner's power-up beeps.

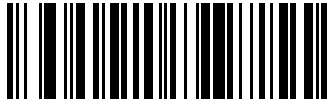

\*Do Not Suppress Power Up Beeps (0)

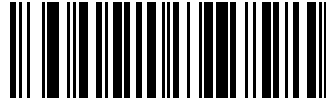

Suppress Power Up Beeps (1)

## LED on Good Decode

### Parameter # 744 (SSI # F1h E8h)

This parameter selects whether or not the LED blinks on a good decode.

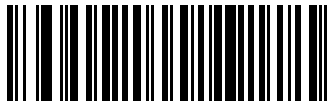

\*Enable LED on Good Decode (2)



Disable LED on Good Decode (0)

## Low Power Mode

### Parameter # 128 (SSI # 80h)

This parameter selects whether or not the scanner enters low power mode after a decode attempt or host communication.

This applies to serial and keyboard wedge connections. If disabled, power remains on after each decode attempt.



**NOTE:** The Low Power Mode parameter only applies for non-USB and non-RS485 host interfaces, and when [Trigger Mode](#) is set to Level1 (Standard).

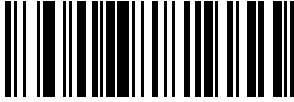

Enable Low Power Mode (1)

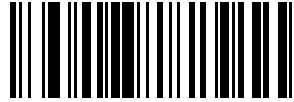

Disable Low Power Mode (0)

## Time Delay to Low Power Mode

### Parameter # 146 (SSI # 92h)

This parameter sets the time the scanner remains active before entering low power mode. The scanner wakes upon trigger press or when the host attempts to communicate with the scanner.

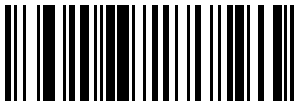

1 Second (17)



10 Seconds (26)



1 Minute (33)

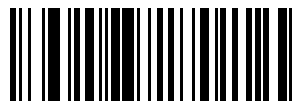

5 Minutes (37)



15 Minutes (43)



30 Minutes (45)



45 Minutes (46)



\*1 Hour (49)

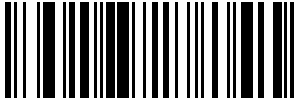

3 Hours (51)



6 Hours (54)

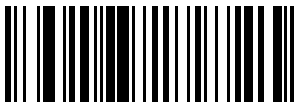

9 Hours (57)

## Trigger Mode

### Parameter # 138 (SSI # 8Ah)

This parameter allows you to change your scanner's behavior to initiate a decode.

Choose one of the following to select a trigger mode for the scanner:

- Standard (Level) - A trigger press activates decode processing. Decode processing continues until the barcode decodes, you release the trigger or the [Decode Session Timeout](#) occurs. If the trigger is released before the timeout expires, the decode session terminates and no decode occurs.
- Presentation (Blink) - The scanner activates decode processing when it detects a barcode in its field of view. After a period of non-use, the LEDs turn off until the scanner senses motion.



Standard (Level) (0)



\*Presentation (Blink) (7)

## Hand-held Decode Aiming Pattern

### Parameter # 306 (SSI # F0h 32h)

This parameter selects when to project the aiming pattern in hand-held mode:

- Enable Hand-held Decode Aiming Pattern - This projects the aiming pattern during barcode capture.
- Disable Hand-held Decode Aiming Pattern - This turns the aiming pattern off.
- Enable Hand-held Decode Aiming Pattern on PDF - This projects the aiming pattern when the scanner detects a PDF barcode.



**NOTE:** With [Picklist Mode](#) enabled, the decode aiming pattern flashes even if you disable the Hand-held Decode Aiming Pattern.

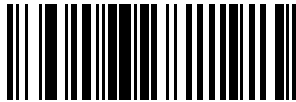

\*Enable Hand-held Decode Aiming Pattern (2)

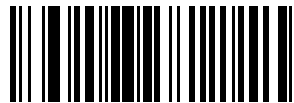

Disable Hand-held Decode Aiming Pattern (0)



Enable Hand-held Decode Aiming Pattern on PDF (3)

## Hands-free (Presentation) Decode Aiming Pattern

### Parameter # 590 (SSI # F1h 4Eh)

This parameter selects when to project the aiming pattern in hands-free mode.

- Enable Hands-free (Presentation) Decode Aiming Pattern - This projects the aiming pattern during barcode capture.
- Disable Hands-free (Presentation) Decode Aiming Pattern - This turns the aiming pattern off.
- Enable Hands-free (Presentation) Decode Aiming Pattern on PDF - This projects the aiming pattern when the scanner detects a PDF barcode.



**NOTE:** With [Picklist Mode](#) enabled, the decode aiming pattern flashes even when you disable the Hands-free Decode Aiming Pattern.



\*Enable Hands-free (Presentation) Decode Aiming Pattern (1)





Disable Hands-free (Presentation) Decode Aiming Pattern (0)



Enable Hands-free (Presentation) Decode Aiming Pattern on PDF (2)

## Momentary Trigger Mode Timeout

### Parameter # 2030 (SSI # EDh)

This parameter sets the length of the period of inactivity in momentary trigger mode before the scanner reverts to presentation mode.

In momentary trigger mode, the aiming pattern appears upon pressing the trigger. Once in this mode, upon each trigger press the scanner attempts to decode the barcode in front of it. After a period of inactivity while the trigger is not pressed, the scanner reverts to presentation mode where there is no illumination until an item is presented.

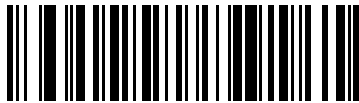

2 Seconds (20)



3 Seconds (30)



4 Seconds (40)



\*5 Seconds (50)

## Picklist Mode

### Parameter # 402 (SSI # F0h 92h)

This parameter selects a Picklist Mode. In this mode, you can pick out and decode a barcode from a group of barcodes that are printed close together by placing the aiming pattern on the barcode you want to decode.



**NOTE:** Enabling Picklist Mode overrides the Disable Decode Aiming Pattern options. You can not disable the decode aiming pattern when Picklist Mode is enabled. Enabling Picklist Mode can slow decode speed and hinder the ability to decode longer barcodes.

- Enable Picklist Mode Always - Picklist Mode is always enabled.
- Enable Picklist Mode in Hand-held Mode - Picklist Mode is enabled when the scanner is out of hands-free mode and disabled when the scanner is in presentation mode.
- Enable Picklist Mode in Hands-free Mode - Picklist Mode is enabled when the scanner is in hands-free mode only.
- Disable Picklist Mode Always - Picklist Mode is always disabled.

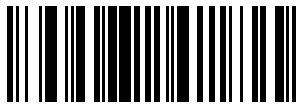

Enable Picklist Mode Always (2)

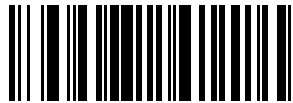

Enable Picklist Mode in Hand-held Mode (1)

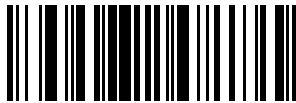

Enable Picklist Mode in Hands-free Mode (3)

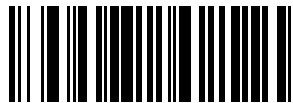

\*Disable Picklist Mode Always (0)

## Continuous Barcode Read

### Parameter # 649 (SSI # F1h 89h)

Enable this parameter to report every barcode while the trigger is pressed.



Enable Continuous Barcode Read (1)

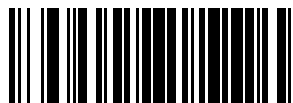

\*Disable Continuous Barcode Read (0)

## Unique Barcode Reporting

### Parameter # 723 (SSI # F1h D3h)

Enable this parameter to report only unique barcodes while the trigger is pressed. This option only applies when Continuous Barcode Read is enabled.



\*Enable Unique Barcode Reporting (1)

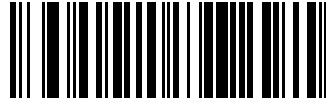

Disable Unique Barcode Reporting (0)

## Decode Session Timeout

### Parameter # 136 (SSI # 88h)

This parameter sets the maximum time decode processing continues during a scan attempt. It is programmable in 0.1 second increments from 0.5 to 9.9 seconds. The default timeout is 9.9 seconds.

To set a Decode Session Timeout, scan the following barcode, and then scan two barcodes from [Numeric Barcodes](#) that correspond to the desired on time. Enter a leading zero for single digit numbers. For example, to set a Decode Session Timeout of 0.5 seconds, scan this barcode, and then scan the 0 and 5 barcodes. To correct an error or change the selection, scan [Cancel](#).



Decode Session Timeout

## Hands-Free Decode Session Timeout

### Parameter # 400 (SSI # F0 90)

This parameter is the hands-free compliment to the Decode Session Timeout. It configures the minimum and maximum decode processing time during a hands-free scan attempt. It only applies to the hands-free trigger mode.

The range for this parameter is with a default value of .

The minimum decode processing time is defined as the time in which the scanner stops decoding when an object is removed or left stationary in the imaging field of view.

The maximum decode processing time is defined as the time in which the scanner stops decoding when an object is left in or is moving in the field of view.

Both the maximum and minimum times are configured using a single setting. The relationship of this setting is as follows:

Setting Value <sup>a</sup>	Minimum Time	Maximum Time
X < 25	250 ms	2.5 seconds
X >= 25	X * 10 ms	X * 100 ms

<sup>a</sup> value must be three digits.

For example, a setting value of 100 results in the scanner turning off approximately 1 second after an object is removed from the field of view or 10 seconds while an object is in the field of view moving.

The default value of the setting is , which results in a minimum time of and a maximum time of .

Adjust this setting based on your requirements. For example, when doing PDF prioritization, this parameter should be set to a value where the maximum time is above the PDF prioritization timeout.

To set a three-digit value, scan the following barcode and then scan three barcodes from [Numeric Barcodes](#). Enter a leading zero for single-digit numbers. To correct an error or change a selection, scan Cancel.

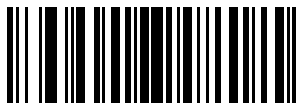

Hands-Free Decode Session Timeout

## Timeout Between Decodes, Same Symbol

### Parameter # 137 (SSI # 89h)

Use this option in presentation mode or Continuous Barcode Read mode to prevent the scanner from continuously decoding the same barcode when it is left in the scanner's field of view. The barcode must be out of the field of view for the timeout period before the scanner reads the same consecutive symbol.

Timeout Between Decodes, Same Symbol is programmable in 0.1 second increments from 0.0 to 9.9 seconds. The default interval is 0.5 seconds.

To select the timeout between decodes for the same symbol, scan the following barcode, and then scan two barcodes from [Numeric Barcodes](#) that correspond to the desired interval, in 0.1 second increments.

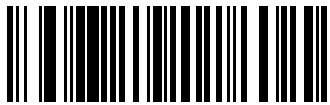

Timeout Between Decodes, Same Symbol

## Timeout Between Decodes, Different Symbols

### Parameter # 144 (SSI # 90h)

Use this option in presentation mode or Continuous Barcode Read to control the time the scanner waits before decoding a different symbol.

Timeout Between Decodes, Different Symbols is programmable in 0.1 second increments from 0.1 to 9.9 seconds. The default is 0.1 seconds.

To select the timeout between decodes for different symbols, scan the following barcode, and then scan two barcodes from [Numeric Barcodes](#) that correspond to the desired interval, in 0.1 second increments.

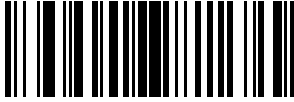

Timeout Between Decodes, Different Symbols

### Mobile Phone/Display Mode

#### Parameter # 716 (SSI # F1h CCh)

This mode improves barcode reading performance off mobile phones and electronic displays. Scan one of the following barcodes to select the desired mode.

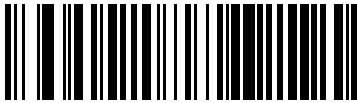

Normal Mobile Phone/Display Mode (0)

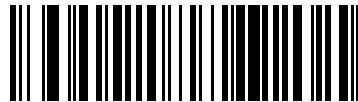

Enhanced in Hand-held Mode (1)

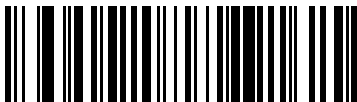

\*Enhanced in Hands-free Mode (2)



Enhanced in Both Modes (3)

### Motion Detect Mode (Wakeup)

#### Parameter # 2377 (SSI # F8 09 49)

This parameter selects the method used to detect motion and activate a decode session.

The available options are:

- Scene Detect - A decode session is triggered when a change in scene (for example, motion) is detected by the imaging sensor. Illumination is turned on and decoding is enabled. Scene Detect does not require illumination to detect a change in scene (for example, Motion). Susceptible to inadvertent wakeup from motion beyond decode zone (for example, people moving past scanner).
- Object Detect - A decode session is triggered when a barcode is detected by the imaging sensor. Illumination is increased and decoding is enabled. Object detect requires some illumination to detect the object (for example, Barcode). Less susceptible than Scene Detect to inadvertent wakeup from motion beyond decode zone (for example, people moving past scanner).

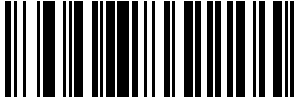

\*Object Detect (1)

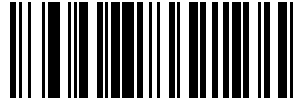

Scene Detect (2)

## PDF Prioritization

### Parameter # 719 (SSI # F4h F1h CFh)

Enable this parameter to delay decoding certain 1D barcodes by the value specified in PDF Prioritization Timeout.

During the [PDF Prioritization Timeout](#) time, the scanner attempts to decode a PDF417 symbol (for example, on a US driver's license), and if successful, reports this only. If it does not decode (cannot find) a PDF417 symbol, it reports the 1D symbol after the timeout. The 1D symbol must be in the device's field of view for the scanner to report it. This parameter does not affect decoding other symbologies.

The 1D Code 128 barcode lengths include the following:

- 7 to 10 characters
- 14 to 22 characters
- 27 to 28 characters

In addition, a Code 39 barcode with the following lengths are considered to potentially be part of a US driver's license:

- 8 characters
- 12 characters



Enable PDF Prioritization (1)



\*Disable PDF Prioritization (0)

## PDF Prioritization Timeout

### Parameter # 720 (SSI # F1h D0h)

If you enabled PDF Prioritization, set this timeout to indicate how long the scanner attempts to decode a PDF417 symbol before reporting the 1D barcode in the field of view.

The PDF Prioritization Timeout range is 0 to 5000 ms, and the default is 200 ms.

Scan the following barcode, and then scan four barcodes from [Numeric Barcodes](#) that specify the timeout in milliseconds. For example, to enter 400 ms, scan the following barcode, and then scan 0400.



PDF Prioritization Timeout

### Presentation Mode Field of View

#### Parameter # 609 (SSI # F1h 61h)

This parameter sets the size of the search area.

In presentation mode, the default setting of Full Field of View allows the scanner to search the entire area of the imaging field of view.

Select Small Field of View or Medium Field of View to search for a barcode in a smaller centered region of the imaging field of view to speed search time.

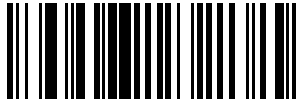

Small Field of View (0)



Medium Field of View (1)

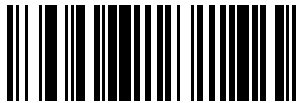

\*Full Field of View (2)

### Mirrored Image

#### Parameter # 624 (SSI # F1h 70h)

Enable this parameter to scan images in reverse, or mirrored, as if seen through a mirror. This mode is useful in applications requiring scanning through a mirror and using symbologies that do not decode in reverse.

Enabling this mode when using snapshot mode transmits images as mirrored images.



Enable Mirrored Image (1)

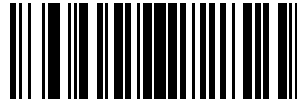

\*Disable Mirrored Image (0)

## Decoding Illumination

### Parameter # 298 (SSI # F0h 2Ah)

This parameter determines whether the scanner turns on illumination to aid decoding. Enabling illumination usually results in superior images and better decode performance. The effectiveness of the illumination decreases as the distance to the target increases.

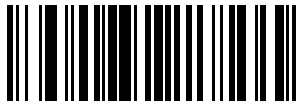

\*Enable Decoding Illumination (1)

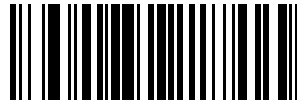

Disable Decoding Illumination (0)

## Illumination Brightness

### Parameter # 669 (SSI # F1h 9Dh)

This parameter sets the illumination brightness by altering LED power.

Illumination Brightness values range from 1 to 10, with 10 being the highest level of brightness. The default is 10.

To set the illumination brightness, scan the following barcode, and then scan two barcodes in [Numeric Barcodes](#) that correspond to the value of desired illumination brightness. For example, to set illumination brightness to 8, scan the Illumination Brightness barcode, and then scan the 0 and 8 barcodes.



Illumination Brightness

## Low Light Scene Detection

### Parameter # 810 (SSI # F2h 2Ah)

This parameter allows the scanner to detect motion in dim to dark illumination environments when in presentation mode.



**NOTE:** This parameter only applies to scene detect mode (presentation configuration).

- No Low Light Scene Detection - The scanner attempts to detect motion as best it can with the aiming pattern and illumination turned off when the scanner is idle.



- Aiming Pattern Low Light Assist Scene Detection - Illumination is off, but the aiming pattern is on when the scanner is idle to assist in scene detection.
- Dim Illumination Low Light Assist Scene Detection - The aiming pattern is off, but illumination is on at a dim level to assist in scene detection.



\*No Low Light Assist Scene Detection (0)

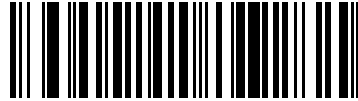

Aiming Pattern Low Light Assist Scene Detection (1)



Dim Illumination Low Light Assist Scene Detection (2)

### Product ID (PID) Type

#### Parameter # 1281 (SSI # F8h 05h 01h)

This parameter defines the PID value reported in USB enumeration.



\*Host Type Unique (0)

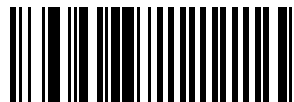

Product Unique (1)



IBM Unique (2)

### Product ID (PID) Value

#### Parameter # 1725 (SSI # F8h 06h BDh)

This parameter sets a Product ID (PID) value.



**NOTE:** This parameter applies to customers using a Firmware Flash Update per the Toshiba Global Commerce Solutions (TGCS) Universal Serial Bus OEM Point-of-Sale Device Interface.

To set a Product ID value, scan Set PID Value, and then scan four numeric barcodes in [Numeric Barcodes](#) that correspond to the value. Enter a leading zero for single-digit numbers. To correct an error, or change a selection, scan [Cancel](#). The range is (0, 1600 - 1649).



Set PID Value

### Alternate Numeric Keypad Emulation

This allows emulation of most other country keyboard types not listed in [Country Code Barcodes](#) on page 359 in a Microsoft® operating system environment.



**NOTE:** If your keyboard type is not listed in the country code list (see [Country Code Barcodes](#) on page 359), disable [USB Quick Keypad Emulation](#) on page 99 and ensure Alternate Numeric Keypad Emulation is enabled.

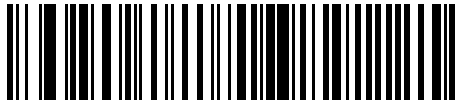

\*Enable Alternate Numeric Keypad

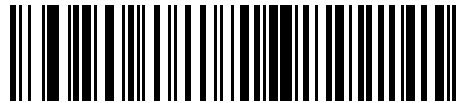

Disable Alternate Numeric Keypad

### Miscellaneous Scanner Parameters

This section provides additional barcodes and parameters for miscellaneous options.

#### Enter Key

This parameter adds an Enter key (carriage return or line feed) after scanned data.

To program other prefixes and/or suffixes, see [Prefix/Suffix Values](#).

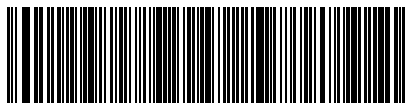

Add Enter Key (Carriage Return/Line Feed)

## Tab Key

This parameter adds a Tab key after scanned data.

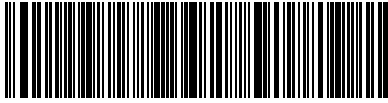

Tab Key

## Transmit Code ID Character

### Parameter # 45 (SSI # 2Dh)

A Code ID character identifies the code type of a scanned barcode. This is useful when decoding more than one code type. In addition to any single character prefix selected, the Code ID character is inserted between the prefix and the decoded symbol.

Select no Code ID character, a Symbol Code ID character, or an AIM Code ID character. For Code ID characters, see [Symbol Code Identifiers](#) and [AIM Code Identifiers](#).



**NOTE:** If you enable Symbol Code ID Character or AIM Code ID Character, and enable [Transmit No Read Message](#), the scanner appends the code ID for Code 39 to the NR message.



Symbol Code ID Character (2)

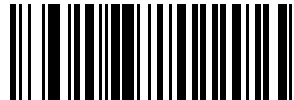

AIM Code ID Character (1)



\*None (0)

## Prefix Suffix Values

**Key Category Parameter # P = 99, S1 = 98, S2 = 100**

**Key Category SSI # P = 63h, S1 = 62h, S2 = 64h**

**Decimal Value Parameter # P = 105, S1 = 104, S2 = 106**

**Decimal Value SSI # P = 69h, S1 = 68h, S2 = 6Ah**

This parameter appends up to one prefix or up to two suffix values to scan data for use in data editing. The default prefix and suffix value is 7013 <CR><LF> (Enter key).



**NOTE:** To use Prefix/Suffix values, first set the [Scan Data Transmission Format](#).

To set a value for a prefix or suffix, scan one of the following barcodes, and then scan four barcodes from [Numeric Barcodes](#) that correspond to that value. See [ASCII Character Sets](#) for the four-digit codes.

When using host commands to set the prefix or suffix, set the key category parameter to 1, and then set the 3-digit decimal value. See [ASCII Character Sets](#) for the four-digit codes.

To correct an error or change a selection, scan [Cancel](#).

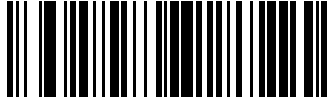

Scan Prefix (7)

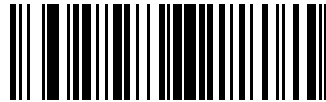

Scan Suffix 1 (6)

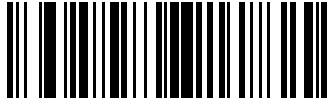

Scan Suffix 2 (8)

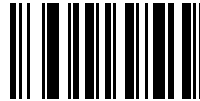

Data Format Cancel

## Scan Data Transmission Format

### Parameter # 235 (SSI # EBh)

This parameter selects the scan data format.



**NOTE:** If using this parameter do not use ADF rules to set the prefix/suffix.

To set values for the prefix or suffix, see [Prefix Suffix Values](#).

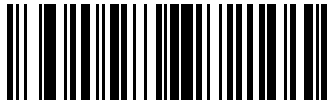

\*Data As Is (0)

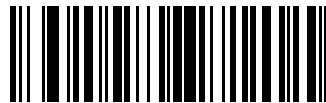

<DATA> <SUFFIX 1> (1)

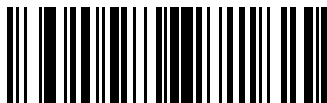

<DATA> <SUFFIX 2> (2)



<DATA> <SUFFIX 1> <SUFFIX 2> (3)

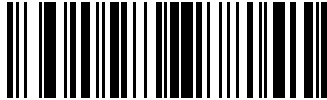

<PREFIX> <DATA > (4)

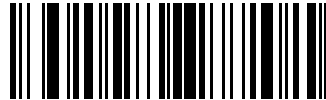

<PREFIX> <DATA> <SUFFIX 1> (5)

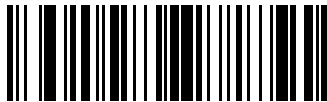

<PREFIX> <DATA> <SUFFIX 2> (6)

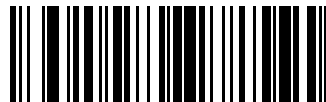

<PREFIX> <DATA> <SUFFIX 1> <SUFFIX 2> (7)

## FN1 Substitution Values

### Key Category Parameter # 103 (SSI # 67h)

### Decimal Value Parameter # 109 (SSI # 6Dh)

Keyboard wedge and USB HID keyboard hosts support a FN1 substitution feature. Enabling this substitutes any FN1 character (0x1b) in an EAN128 barcode with a value. This value defaults to 7013 <CR><LF> (Enter key).

When using host commands to set the FN1 substitution value, set the key category parameter to 1, and then set the 3-digit keystroke value. See the [ASCII Character Sets](#) on page 334 for the current host interface for the desired value.

### Selecting a FN1 Substitution Value

Select a FN1 substitution value via the following barcode menus.

1. Scan the following barcode.

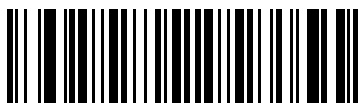

Set FN1 Substitution Value

2. Locate the keystroke desired for FN1 Substitution in the ASCII Character Set table for the current host interface, and enter the 4-digit ASCII value by scanning four barcodes from [Numeric Barcodes](#).

To correct an error or change the selection, scan [Cancel](#).

To enable FN1 substitution for USB HID keyboard, scan the [USB Keyboard FN1 Substitution](#) on page 100 barcode.

### FN1 Substitution

Select Enable FN1 Substitution to replace FN1 characters in an EAN128 barcode with a user-selected keystroke (see [FN1 Substitution Values](#)).

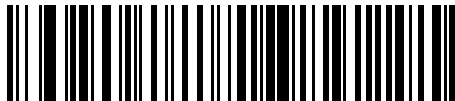

Enable FN1 Substitution



\*Disable FN1 Substitution

### Report Software Version

When contacting support, a support representative may ask you to scan the bar code below to determine the version of software installed in the digital scanner.



Report Software Version

### Transmit No Read Message

#### Parameter # 94 (SSI # 5Eh)

This parameter sets an option for transmitting the No Read (NR) characters.



**NOTE:** If you enable Transmit No Read, and also enable Symbol Code ID Character or AIM Code ID Character for [Transmit Code ID Character](#), the scanner appends the code ID for Code 39 to the NR message.

This does not apply in presentation mode.

- Enable No Read - transmits the characters NR when a successful decode does not occur before trigger release or the expires.
- Disable No Read - sends nothing to the host if a symbol does not decode.

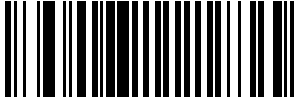

Enable No Read (1)

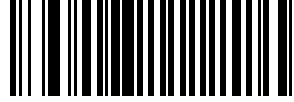

\*Disable No Read (0)

## Unsolicited Heartbeat Interval

### Parameter # 1118 (SSI # F8h 04h 5Eh)

When this parameter is enabled, the scanner can send unsolicited heartbeat messages to assist in diagnostics. The range is 0 - 9999.

The heartbeat event is sent as decode data (with no decode beep) in the form of:

```
MOTEVTHB : nnn
```

Where: nnn is a three-digit sequence number starting at 001 and wrapping after 100.

To enable this parameter and set the desired unsolicited heartbeat interval, scan one of the following time interval barcodes, or scan Set Another Interval followed by four barcodes from [Numeric Barcodes](#) that correspond to the desired number of seconds.

Scan Disable Unsolicited Heartbeat Interval to turn off the feature.

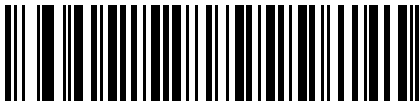

10 Seconds (10)

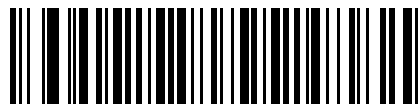

1 Minute (60)



Set Another Interval



\*Disable Unsolicited Heartbeat Interval (0)

# Driver's License Set Up

The scanner uses internally embedded algorithms to parse out barcode information from standard US driver's licenses and certain other American Association of Motor Vehicle Administrators (AAMVA) compliant ID cards. Scanning these barcodes produces formatted data for use in age verification, credit card application information, and more.



**NOTE:** Only applies to -DL and -LL model digital scanners. North America configurations only.

This section describes how to program the scanner to read and use the data contained in the 2D barcodes on US driver's licenses and AAMVA compliant ID cards.

**Table 24** DL Parsing Parameter Table

Parameter	Default
<b>DL Parsing Parameters</b>	
Driver's License Parsing	No Driver's License Parsing
Parsing Driver's License Data Fields	N/A
Driver's License Parse Rules	N/A
AAMVA Parse Fields	N/A
Set Default Parameter	N/A
Output Gender as M or F	N/A
Date Format	CCYYMMDD
No Separator	N/A
Send Keystroke Control Characters Keyboard Characters	N/A
Parsing Rule Example	N/A
Embedded Driver's License Parsing ADF Example	N/A

## Driver's License Parsing

### Parameter # 645 (SSI #F1 85)

This parameter enables driver's license parsing on the scanner.



**NOTE:** This does not require Zebra software (.DLL).



Choose more options in the order indicating the sequence of data fields that the scanner outputs. See [Parsing Driver's License Data Fields](#) for more information.

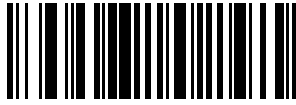

\*No Driver's License Parsing



Embedded Driver's License Parsing

### Parsing Driver's License Data Fields (Embedded Driver's License Parsing)

To program a parsing rule:

1. Choose [Begin New Driver's License Parse Rule](#).
2. Choose any of the field options on the following pages, or [Send Keystroke \(Control Characters and Keyboard Characters\)](#).
3. After entering the entire rule, select [Save Driver's License Parse Rule](#) to save the rule.



**NOTE:** The scanner stores only one driver's license parsing rule in memory at a time. Saving a new rule replaces the prior rule.

To abort the programming sequence at any time during programming, choose [Quit Entering Driver's License Rule](#). Any previously saved rule is retained.

To erase a saved rule, select [Erase Driver's License Parse Rules](#).

### Embedded Driver's License Parsing Criteria - Code Type

After specifying the fields and their order for the parsed driver's license, you can also apply standard ADF rules to the parsed data using the **Parsed Driver's License** criterion barcode in the Advanced Data Formatting Programmer Guide.



**NOTE:** Only create standard ADF rules on parsed driver's license data when configured for Embedded Driver's License Parsing.

See [Embedded Driver's License Parsing ADF Example](#) for a sample ADF rule using this code type criterion.

### Driver's License Parse Rules

Choose an option to program a parsing rule.

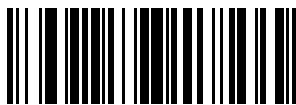

Begin New Driver's License Parse Rule



Save Driver's License Parse Rule



Quit Entering Driver's License Rule



Erase Driver's License Parse Rules

## Driver's License Parse Fields

These options are the supported parse fields for driver's license.

Not all IDs present data in the same format. For example, some IDs can have separate fields for first name, last name, and middle initial, while others have a single field with the entire name. Also, some IDs expire on the subject's birth date while the expiration date field only indicates the year. To present data in a consistent format, use the nine options provided in this section to return data calculated from the actual data contained in the ID barcode.



First Name

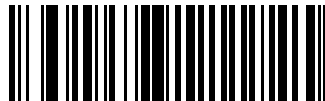

Middle Name/Initial



Last Name

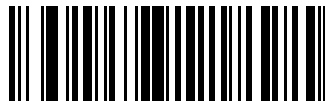

Name Suffix



Name Prefix

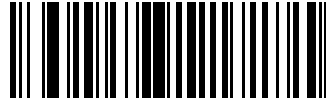

Expiration Date



Birth Date

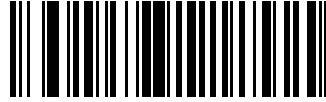

Issue Date



ID Number (Formatted)

## AAMVA Parse Fields

The scanner uses the specified fields to parse out information from American Association of Motor Vehicle Administrators (AAMVA) compliant ID cards.



AAMVA Issuer ID



Full Name



Last Name



First Name



Middle Name / Initial

# Driver's License Set Up



Name Suffix



Name Prefix



Mailing Address Line 1



Mailing Address Line 2



Mailing Address City



Mailing Address State



Mailing Address Postal Code

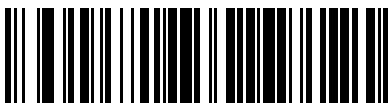

Home Address Line 1



Home Address Line 2



Home Address City

## Driver's License Set Up



Home Address Postal Code



License Class



License Endorsements



Height (Centimeters)

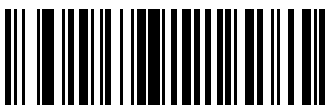

Weight (Kilograms)



Home Address State



License ID Number



License Restrictions

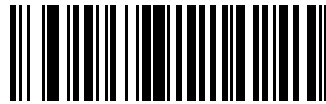

Height (Feet and/or Inches)

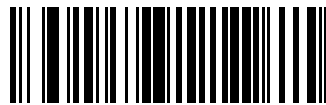

Weight (Pounds)

# Driver's License Set Up



Hair Color

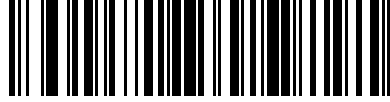

Eye Color



License Expiration Date



Birth Date



Gender



License Issue Date



License Issue State

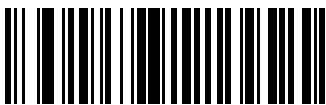

Social Security Number



Permit Class

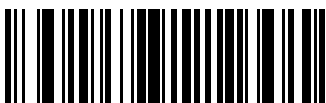

Permit Expiration Date



Permit ID Number



Permit Issue Date

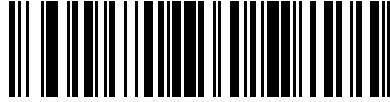

Permit Restrictions

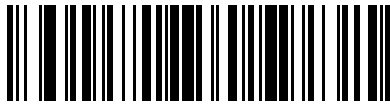

Permit Endorsements



AKA Social Security Name

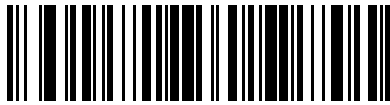

AKA Full Name



AKA Last Name



AKA First Name



AKA Middle Name / Initial



AKA Name Suffix

# Driver's License Set Up



AKA Birth Date



AKA Name Prefix

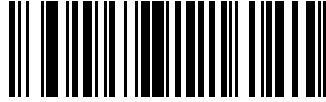

Issue Timestamp



Medical Codes

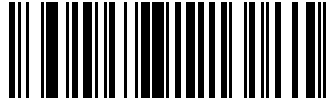

Organ Donor

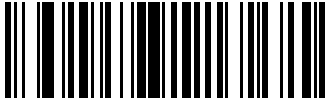

Nonresident

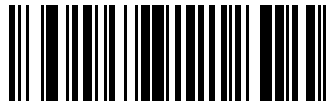

Customer ID

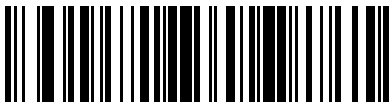

Weight Range

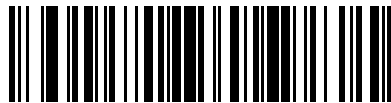

Document Discriminator

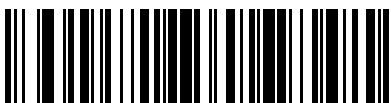

Country





Place of Birth

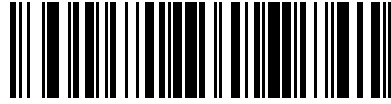

Federal Commission Codes



Audit Information

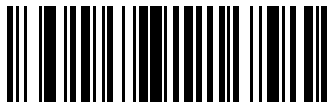

Inventory Control

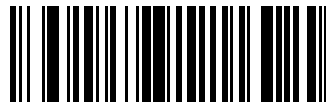

Race / Ethnicity



Std Vehicle Class

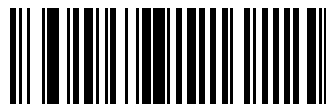

Std Endorsements



Std Restrictions

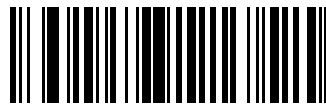

Class Description



Endorsement Description



Restrictions Description



Height in Inches

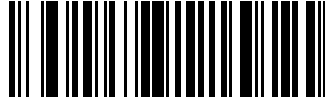

Height in Centimeters



Std Endorsements

### Parser Version ID Barcode

Include this field to emit embedded parser software version identification.



Parser Version ID

### DL Parsing User Preferences

Use the following barcodes to set user preferences.

#### Set Default Parameter

This parameter returns all parameters to the default values.

See the default value tables in each section.



\*Set All Defaults

## Output Gender as M or F

Select this parameter to report the gender as M or F instead of a numeric value.



Output gender as M or F

## Date Format

Use this parameter to select the date format to display.

Date fields include the following:

- CCYY = 4-digit year (CC=2-digit century [00-99], YY=2-digit year in the century [00-99])
- MM = 2-digit month [01-12]
- DD = 2-digit day of the month [00-31]

To specify a date separator, for example, a character separating each field of the date, select the Send option that corresponds to the alphanumeric character to use as the date separator immediately following the date format barcode. To select no date separator, select the No Separator DL parsing rule immediately following the date format.

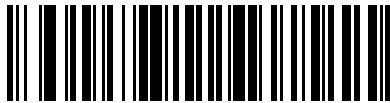

DDMMCCYY

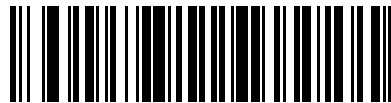

DDCCYYMM



YYMMDD



YYDDMM

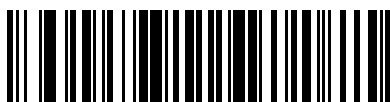

MMDDYY



MMYDD



DDMMYY



DDYYMM

### No Separator

This parameter immediately follows a date format barcode to use no separator character between the date fields.



No Separator

### Send Keystroke (Control Characters and Keyboard Characters)

Specify a Control Character or a Keyboard Character to send.

#### Control Characters

Select a Send Control parameter for the control character to send.



Send Control A



Send Control B



Send Control C



Send Control D



Send Control E



Send Control F

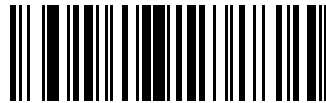

Send Control G



Send Control H

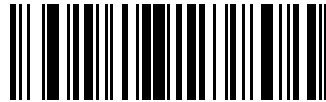

Send Control I

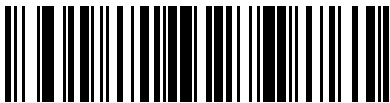

Send Control J



Send Control K



Send Control L

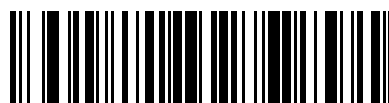

Send Control M



Send Control N

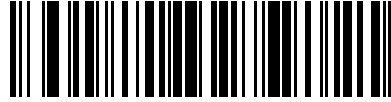

Send Control O

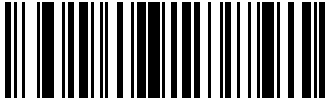

Send Control P

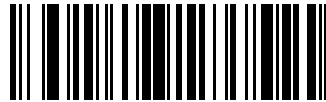

Send Control Q



Send Control R

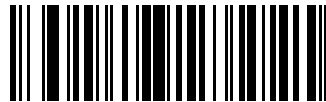

Send Control S

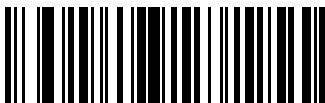

Send Control T



Send Control U

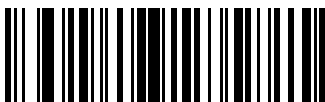

Send Control V



Send Control X

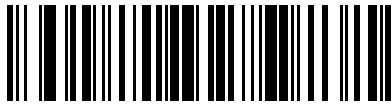

Send Control Z

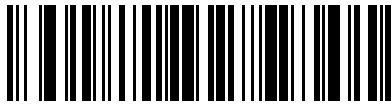

Send Control \



Send Control 6

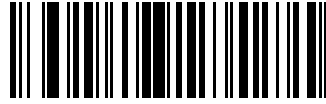

Send Control W

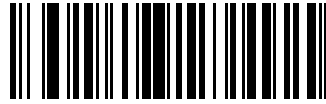

Send Control Y



Send Control [

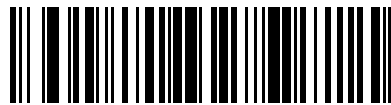

Send Control ]

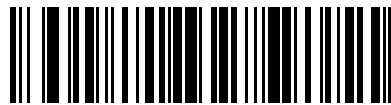

Send Control -

## Keyboard Characters

Select a Send parameter for the specific keyboard characters to send.



Send Space

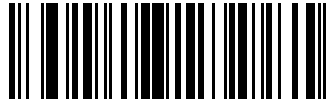

Send !



Send "

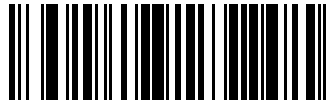

Send #



Send \$

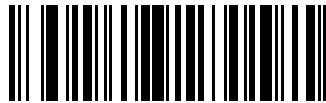

Send %

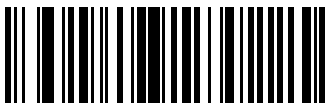

Send &

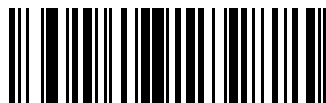

Send '

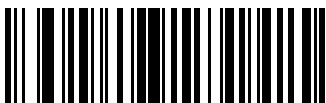

Send (/)



# Driver's License Set Up



Send \*

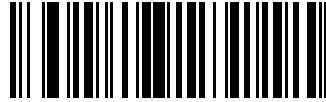

Send )



Send +



Send ,

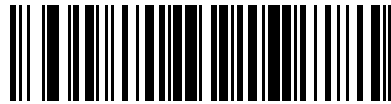

Send -



Send .

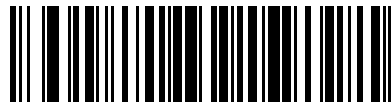

Send /

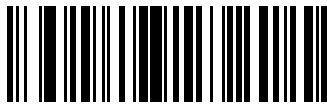

Send 0

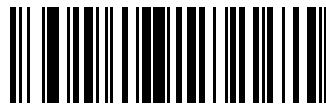

Send 1

# Driver's License Set Up



Send 2

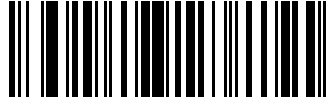

Send 3



Send 4

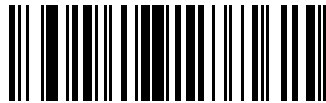

Send 5

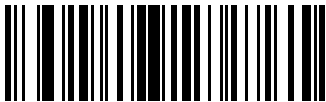

Send 6



Send 7



Send 8



Send 9



Send :

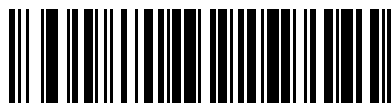

Send ;



Send <

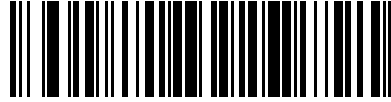

Send =

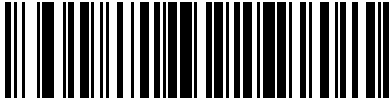

Send >

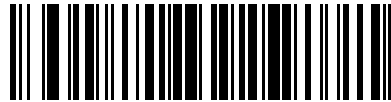

Send ?



Send @

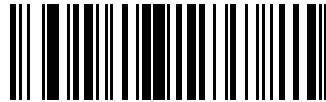

Send A

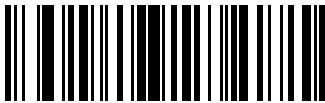

Send B

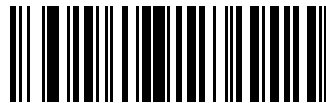

Send C



Send D

# Driver's License Set Up



Send F



Send H

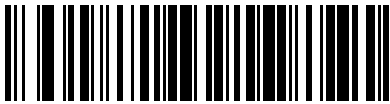

Send J

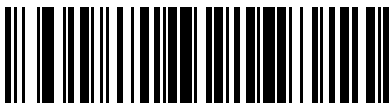

Send L



Send N

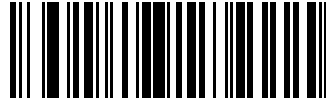

Send E

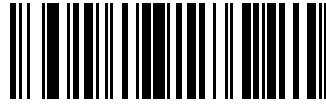

Send G



Send I

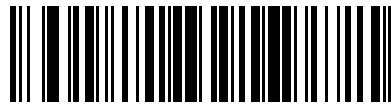

Send K

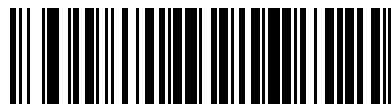

Send M

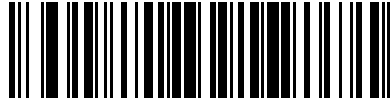

Send O



Send P

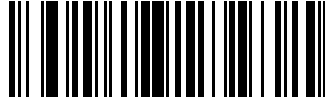

Send Q



Send R

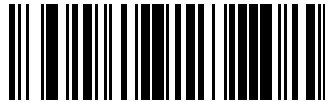

Send S



Send T

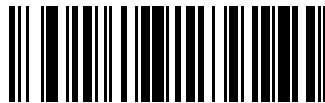

Send U



Send V

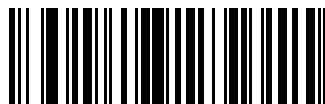

Send W

# Driver's License Set Up



Send X



Send Y

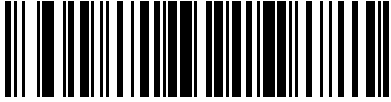

Send Z

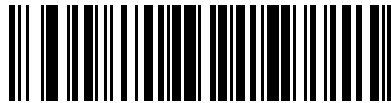

Send [

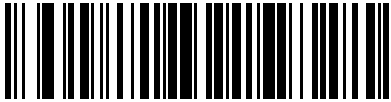

Send \



Send ]

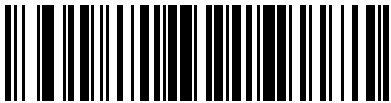

Send ^

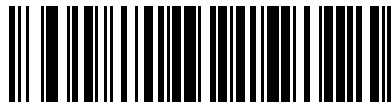

Send \_

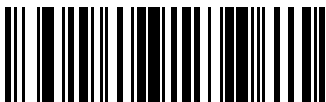

Send `



Send a

# Driver's License Set Up

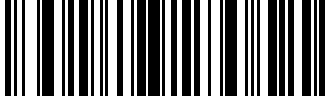

Send b

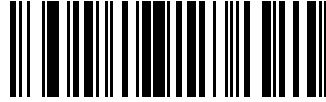

Send c

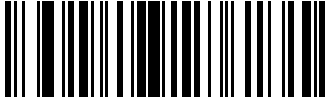

Send d

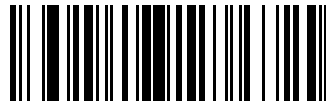

Send e

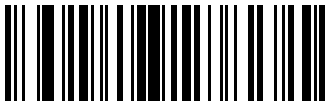

Send f



Send g



Send h



Send i



Send j

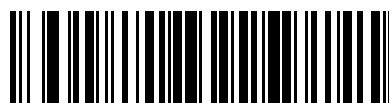

Send k

# Driver's License Set Up



Send l

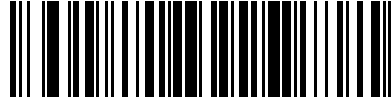

Send m

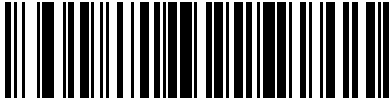

Send n

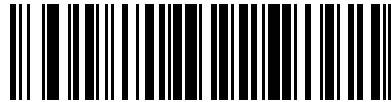

Send o



Send p



Send q

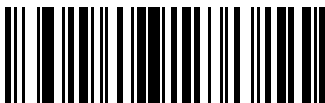

Send r



Send s



Send t





Send v

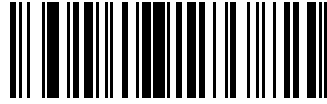

Send u

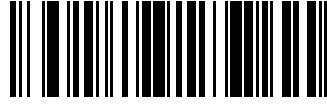

Send w



Send x



Send y

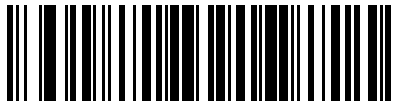

Send z

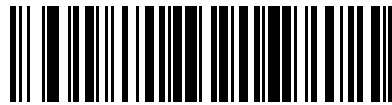

Send {

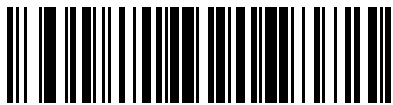

Send |

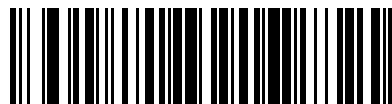

Send }

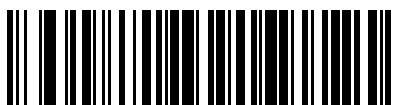

Send ~



Send Tab Key



Send Enter Key

## Parsing Rule Example

Follow the sequence to examine how a parsing rule is created.

Choose the parameters in sequence to program the scanner to extract and transmit:

- first, middle, and last names
- mailing address line 1
- mailing address line 2
- mailing address city
- mailing address state
- mailing address postal code
- date of birth

Then, scan a driver's license barcode.



**NOTE:** This example applies to RS-232. To use this example with a USB interface, enable [USB Function Key Mapping](#) to send the Enter key properly.



1 - Embedded Driver's License Parsing



2 - Begin New Driver's License Parse Rule

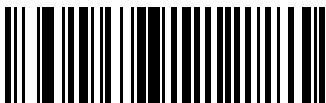

3 - First Name



4 - Send Space



5 - Middle Name / Initial

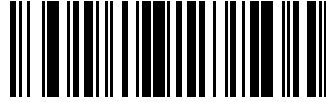

6 - Send Space

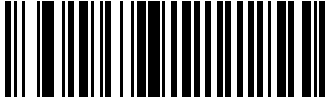

7 - Last Name

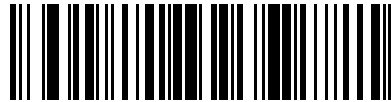

8 - Send Enter Key



9 - Mailing Address Line 1

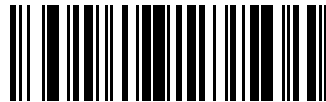

10 - Send Space



11 - Mailing Address Line 2

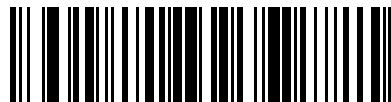

12 - Send Enter Key



13 - Mailing Address City

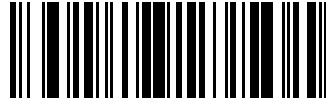

14 - Send Space



15 - Mailing Address State

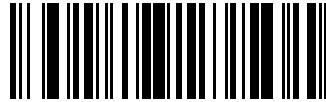

16 - Send Space

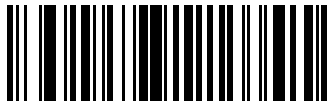

17 - Mailing Address Postal Code



18 - Send Enter Key

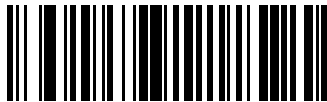

19 - Birth Date

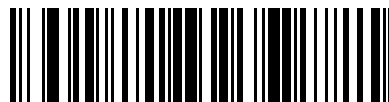

20 - Send Enter Key



21 - Save Driver's Licence Parse Rule

## Embedded Driver's License Parsing ADF Example

This example creates a parsing rule for parsed data.

The parsing rule configures the data in the following format:

```
Last Name, First Name
```

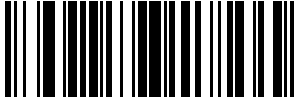

1 - Begin New Driver's License Parse Rule

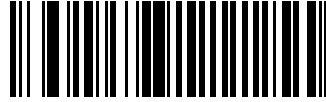

2 - Last Name

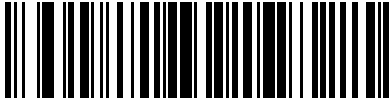

3 - Send ,

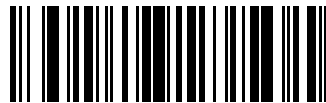

4 - Send Space



5 - First Name



6 - Save Driver's License Parse Rule

Then, in order to limit the full name to 15 characters, create the following ADF rule:



1 - Begin New Rule

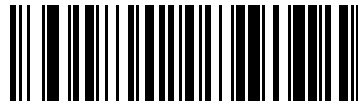

2 - Criterion: Parsed Driver's License

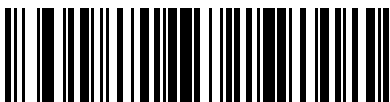

3 - Action: Send Next 15 Characters



4 - Save Rule

For a license belonging to Michael Williams, the parsed data is Williams, Michael and Williams, Micha after applying the previous ADF rule.

# Image Capture Preferences

You can program the imager to perform various functions, or you can activate different features. This section describes image capture preference features and provides programming barcodes for selecting these features.



**NOTE:** Only the Symbol Native API (SNAPI) with Imaging interface supports image capture. See [USB Device Type](#) to enable this host.

## Setting Image Capture Parameters

To set feature values, scan a single barcode or a short barcode sequence. The settings are stored in non-volatile memory and are preserved even when the imager powers down.



**NOTE:** Most computer monitors allow scanning barcodes directly on the screen. When scanning from the screen, be sure to set the document magnification to a level where you can see the barcode clearly, and bars and/or spaces do not merge.

To return all features to default values, scan the [Default Parameters](#) barcode. Throughout the programming barcode menus, asterisks (\*) indicate default values, followed by the feature description and value.

## Image Capture Scanning Sequence Examples

You can scan a barcode to set a parameter value.

For example, to disable image capture illumination, scan the Disable Image Capture Illumination barcode found in [Image Capture Illumination](#). After enabling this setting, the imager issues a fast warble beep and the LED turns green, signifying a successful parameter entry.

Other parameters require scanning several barcodes. See the parameter descriptions for this procedure.

## Image Capture Errors While Scanning

Unless otherwise specified, to correct an error during a scanning sequence, just re-scan the correct parameter.

## Image Capture Preferences Default Parameters

The image capture preferences parameter defaults lists defaults for image capture preference parameters.

You can change values in one of two ways:

- Scan the appropriate barcodes in this chapter. The new value replaces the standard default value in memory. To recall default parameter values, see [Default Parameters](#) on page 128.
- Configure the scanner using the 123Scan configuration program. See [123Scan and Software Tools](#).

**Table 25** Image Capture Preferences Parameter Defaults

Parameter	Parameter Number <sup>a</sup>	SSI Number <sup>b</sup>	Default
<b>Image Capture Preferences</b>			
<a href="#">Operational Modes</a>	N/A	N/A	N/A
<a href="#">Image Capture Illumination</a>	361	F0h 69h	Enable
<a href="#">Image Capture Autoexposure</a>	360	F0h 68h	Enable
<a href="#">Fixed Exposure</a>	567	F4h F1h 37h	100
<a href="#">Gain / Exposure Priority for Snapshot Mode</a>	562	F1h 32h	Autodetect
<a href="#">Snapshot Mode Timeout</a>	323	F0h 43h	0 (30 seconds)
<a href="#">Snapshot Aiming Pattern</a>	300	F0h 2Ch	Enable
<a href="#">Silence Operational Mode Changes</a>	1293	F8h 05h 0Dh	Disable (do not silence)
<a href="#">Image Cropping</a>	301	F0h 2Dh	Disable
<a href="#">Crop to Pixel Addresses</a>	315 316 317 318	F4h F0h 3Bh F4h F0h 3Ch F4h F0h 3Dh F4h F0h 3Eh	0 top 0 left 799 bottom 1279 right
<a href="#">Image Size (Number of Pixels)</a>	302	F0h 2Eh	Full
<a href="#">Image Brightness (Target White)</a>	390	F0h 86h	180
<a href="#">JPEG Image Options</a>	299	F0h 2Bh	Quality
<a href="#">JPEG Quality Value</a>	305	F0h 31h	65
<a href="#">JPEG Size Value</a>	561	F1h 31h	160 kB
<a href="#">Image Enhancement</a>	564	F1h 34h	Low (1)
<a href="#">Image File Format Selection</a>	304	F0h 30h	JPEG
<a href="#">Image Rotation</a>	665	F1h 99h	0°
<a href="#">Bits per Pixel (BPP)</a>	303	F0h 2Fh	8 BPP
<a href="#">Signature Capture</a>	93	5Dh	Disable
<a href="#">Signature Capture Image File Format Selection</a>	313	F0h 39h	JPEG
<a href="#">Signature Capture Bits per Pixel (BPP)</a>	314	F0h 3Ah	8 BPP
<a href="#">Signature Capture Width</a>	366	F4h F0h 6Eh	400



**Table 25** Image Capture Preferences Parameter Defaults (Continued)

Parameter	Parameter Number <sup>a</sup>	SSI Number <sup>b</sup>	Default
Signature Capture Height	367	F4h F0h 6Fh	100
Signature Capture JPEG Quality	421	F0h A5h	65
Video View Finder	324	F0h 44h	Disable
Video View Finder Image Size	329	F0h 49h	1700 bytes

<sup>a</sup> Parameter number decimal values are used for programming via RSM commands.

<sup>b</sup> SSI number hex values are used for programming via SSI commands.

## Image Capture Preferences Modes and Parameters

The parameters in this section control image capture characteristics.

### Operational Modes

The scanner can have up to two modes of operation.

- Decode Mode
- Snapshot Mode

#### Decode Mode

By default, when you press the trigger the imager attempts to locate and decode enabled barcodes within its field of view. The imager remains in this mode as long as the trigger is active, until it decodes a barcode, or it reaches the [Decode Session Timeout](#) on page 139.

#### Snapshot Mode

Use Snapshot Mode to capture a high-quality image and transmit it to the host. Select the Snapshot Mode option to temporarily enter this mode. While in this mode the imager blinks the green LED at one-second intervals to indicate it is not in standard operating (decode) mode.

In Snapshot Mode, the imager turns on its aiming pattern to highlight the area to capture in the image. The next trigger press instructs the imager to capture a high quality image and transmit it to the host. A short time may pass (less than two seconds) between when the trigger is pressed and the image is captured as the imager adjusts to lighting conditions.

If you do not press the trigger within the Snapshot Mode Timeout period, the imager returns to Decode Mode. Use [Snapshot Mode Timeout](#) to adjust this timeout period. The default timeout period is 30 seconds.



Snapshot Mode

## Image Capture Illumination

### Parameter # 361 (SSI # F0h 69h)

This parameter turns on illumination during every image capture.

- Enabled - Illumination is on during image capture.
- Disabled - Prevents the imager from using illumination.



**NOTE:** This usually results in superior images. The effectiveness of illumination decreases as the distance to the target increases.



\*Enable Image Capture Illumination (1)



Disable Image Capture Illumination (0)

## Image Capture Autoexposure

### Parameter # 360 (SSI # F0h 68h)

This parameter enables the imager to control gain and exposure (integration time) settings to best capture an image for Snapshot mode.

- Enabled - Allows the imager to control gain and exposure settings to best capture an image.
- Disabled - Manually adjust the gain and exposure time.



**NOTE:** Disabling Image Capture Autoexposure is only recommended for advanced users with difficult image capture situations.



\*Enable Image Capture Autoexposure (1)



Disable Image Capture Autoexposure (0)

## Fixed Exposure

### Parameter # 567 (SSI # F4h F1h 37h)

This parameter configures the exposure used in manual mode for Snapshot and Video modes. Each integer value represents 10 microseconds of exposure. The default value is 100 which results in an exposure setting of 10 ms.

Type: Word

Range: 5–30000

To set the exposure, scan the Fixed Exposure barcode, and then scan four numeric barcodes from [Numeric Barcodes](#) representing the value. Leading zeros are required. For example, to set a Fixed Exposure value of 99, scan 0, 0, 9, 9.



Fixed Exposure (4 digits)

## Gain/Exposure Priority for Snapshot Mode

### Parameter # 562 (SSI # F1h 32h)

This parameter alters the imager's gain exposure priority when it acquires an image in Snapshot Mode while in autoexposure mode.

- Low Exposure Priority - The imager favors higher gain over exposure to capture an image, resulting in an image that is less susceptible to motion blur at the expense of noise artifacts. However, for most applications, the amount of noise is acceptable.
- Low Gain Priority - The imager favors longer exposure time rather than higher gain to capture an image, ensuring the image is less noisy and produces fewer artifacts during post processing activities like image enhancement (sharpening). This mode is recommended for fixed mount / fixed object image capture since the image acquired is susceptible to motion blur.
- Autodetect - The imager automatically selects Gain Priority or Low Exposure Priority mode for Snapshot Mode. If the imager is in a magnetic reed switch-enabled stand (or it is configured in Blink Mode), it uses Low Gain Priority. Otherwise, it uses the Low Exposure Priority.

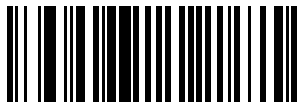

Low Gain Priority (0)

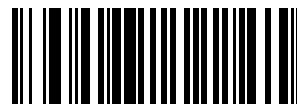

Low Exposure Priority (1)

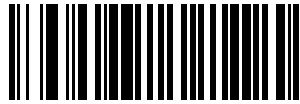

\*Autodetect (2)

## Snapshot Mode Timeout

### Parameter # 323 (SSI # F0h 43h)

This parameter sets the amount of time the imager remains in Snapshot Mode.

- Set Snapshot Mode Timeout - scan this parameter and then scan a barcode from [Numeric Barcodes](#). Values increment by 30. For example, 1 = 60 seconds, 2 = 90 seconds.
- 30 Seconds - resets timeout to 30 seconds.
- No Timeout - the imager remains in Snapshot Mode until you press the trigger.

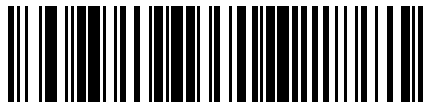

Set Snapshot Mode Timeout

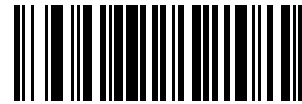

\*30 Seconds

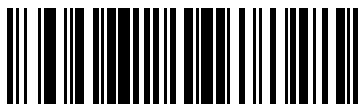

No Timeout

## Snapshot Aiming Pattern

### Parameter # 300 (SSI # F0h 2Ch)

This parameter determines whether or not to project the aiming pattern when in Snapshot Mode.

- Enabled - The aiming pattern frames the image for aiming purposes and does not appear in the captured image.
- Disabled - The aiming pattern does not frame the image for aiming purposes.

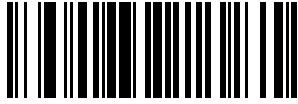

\*Enable Snapshot Aiming Pattern (1)

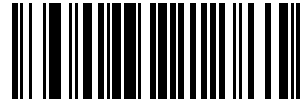

Disable Snapshot Aiming Pattern (0)

## Silence Operational Mode Changes

### Parameter # 1293 (SSI # F8h 05h 0Dh)

This parameter silences the beeper when switching between operational modes (for example, from Decode Mode to Snapshot Mode).

- Enabled - Silences the beep when switching between operational modes.
- Disabled - Allows the beep when switching between operational modes.



Silence Operational Mode Changes (Enable) (1)

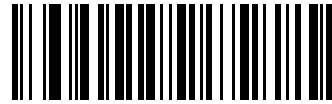

\*Do Not Silence Operational Mode Changes (Disable) (0)

## Image Cropping

### Parameter # 301 (SSI # F0h 2Dh)

This parameter crops a captured image to the pixel addresses set in Crop to Pixel Addresses.

- Enabled - Crops the captured image.
- Disabled - Does not crop the captured image.

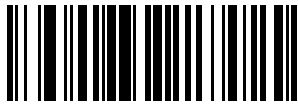

Enable Image Cropping (1)

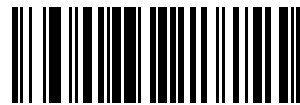

\*Disable Image Cropping (Use Full [1280 x 800] Pixels) (0)

## Crop to Pixel Addresses

**Parameter # 315 (SSI # F4h F0h 3Bh)** (Top)

**Parameter # 316 (SSI # F4h F0h 3Ch)** (Left)

**Parameter # 317 (SSI # F4h F0h 3Dh)** (Bottom)

**Parameter # 318 (SSI # F4h F0h 3Eh)** (Right)

When Image Cropping is enabled, use this parameter to set the pixel addresses.

The pixel addresses value range is (0,0) to 1279 x 799.

- Top Pixel Address - A value with the left pixel address to begin an image crop.
- Left Pixel Address - A value with the top pixel address to begin an image crop.
- Right Pixel Address - A value with the right pixel address to end an image crop.
- Bottom Pixel Address - A value with the right pixel address to end an image crop.

Columns are numbered from 0 to 1279, rows from 0 to 799. Specify values for Top, Left, Bottom, and Right, where Top and Bottom correspond to row pixel addresses, and Left and Right correspond to column pixel addresses.



**NOTE:** The imager has a cropping resolution of 4 pixels. Setting the cropping area to less than 4 pixels (after resolution adjustment, see [Image Size](#)) transfers the entire image.

To crop to the pixel addresses, enable Image Cropping, and then scan four numeric barcodes from [Numeric Barcodes](#) representing the value.

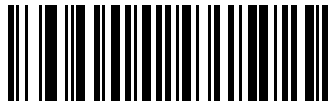

Top Pixel Address (0 - 799 Decimal)

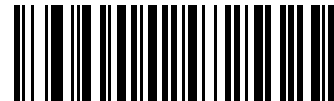

Left Pixel Address (0 - 1279 Decimal)



Bottom Pixel Address (0 - 799 Decimal)



Right Pixel Address (0 - 1279 Decimal)

## Image Size (Number of Pixels)

**Parameter # 302 (SSI # F0h 2Eh)**

This option alters image resolution before compression. Multiple pixels are combined into one pixel, resulting in a smaller image containing the original content with reduced resolution.

Select a resolution value to produce an image size.

**Table 26** Image Size

Resolution Value	Uncropped Image Size
Full	1280 x 800
1/2	640 x 400
1/4	320 x 200



\*Full Resolution (0)



1/2 Resolution (1)

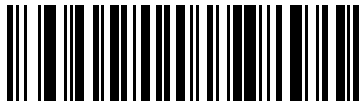

1/4 Resolution (3)

## Image Brightness (Target White)

### Parameter # 390 (SSI # F0h 86h)

This parameter sets the Target White value used in Snapshot and Video Viewfinder modes when using auto exposure.

Type: Byte

Range: 1–240

- Image Brightness (3 digits) - Represents the image brightness value. White and black are defined as 240 decimals and 1, respectively.
- 180 - Sets the white level of the image to ~180.

Scan Image Brightness, and then scan three numeric barcodes from [Numeric Barcodes](#) representing the value. Leading zeros are required. For example, to set an Image Brightness value of 99, scan 0, 9, 9.

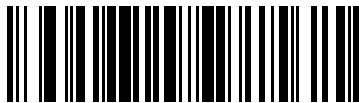

\*180



Image Brightness (3 digits)

## JPEG Image Options

### Parameter # 299 (SSI # F0h 2Bh)

This parameter changes the JPEG image quality or size.

- **JPEG Quality Selector**- Enter a quality value via the [JPEG Quality Value](#) parameter; the imager then selects the corresponding image size.
- **JPEG Size Selector**- Enter a size value via the [JPEG Size Value](#) parameter; the imager then selects the best image quality.

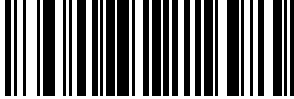

\*JPEG Quality Selector (1)



JPEG Size Selector (0)

## JPEG Quality Value

### Parameter # 305 (SSI # F0h 31h)

This parameter adjusts the quality of the JPEG.



**NOTE:** Use this parameter if you selected **JPEG Quality Selector** as a JPEG Image Option.

Scan **JPEG Quality Value**, and then scan three barcodes from [Numeric Barcodes](#) corresponding to a value from 5 to 100, where 100 represents the highest quality image. Leading zeros are required. For example, to set an image quality value of 55, scan 0, 5, 5.

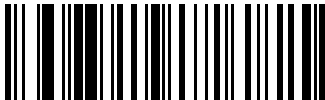

JPEG Quality Value (Default: 065) (5 - 100 Decimal)

## JPEG Size Value

### Parameter # 561 (SSI # F1h 31h)

Type: Word

Range: 5-350

If you selected **JPEG Size Selector**, use **JPEG Size Value** to set the JPEG size.



**CAUTION:** JPEG compression may take 10 to 15 seconds based on the amount of information in the target image. Selecting [JPEG Quality Selector](#) produces a compressed image that is consistent in quality and compression time.



To set the JPEG size, scan **JPEG Size Value** and then scan three numeric barcodes from [Numeric Barcodes](#) representing the target JPEG file size in kilobytes (KB). Leading zeros are required. For example, to set an image file size value of 99, scan 0, 9, 9.

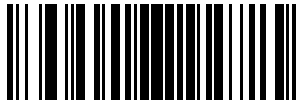

JPEG Size Value (Default: 160) (3 digits)

### Image Enhancement

#### Parameter # 564 (SSI # F1h 34h)

This parameter uses a combination of edge sharpening and contrast enhancement to produce an image that is visually pleasing.

Select the level of image enhancement:

- Off (0)
- \*Low (1)
- Medium (2)
- High (3)

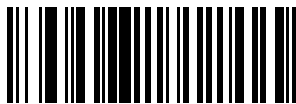

Off (0)

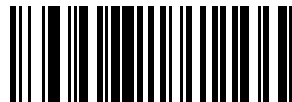

\*Low (1)



Medium (2)

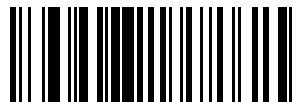

High (3)

### Image File Format Selector

#### Parameter # 304 (SSI # F0h 30h)

## Image Capture Preferences

Use this parameter to select an image format appropriate for the system (BMP, TIFF, or JPEG). The imager stores captured images in the selected format.



BMP File Format (3)

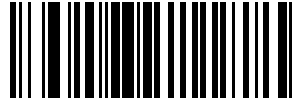

\*JPEG File Format (1)

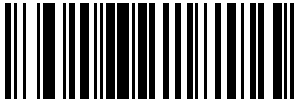

TIFF File Format (4)

### Image Rotation

#### Parameter # 665 (SSI # F1h 99h)

Use this parameter to rotate an image by 90-degree increments (0, 90, 180, or 270).

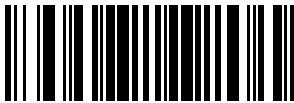

\*Rotate 0° (0)



Rotate 90° (1)

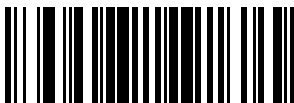

Rotate 180° (2)



Rotate 270° (3)

### Bits Per Pixel

#### Parameter # 303 (SSI # F0h 2Fh)

Use this parameter to select the number of significant bits per pixel (BPP) to use when capturing an image.

- 1 BPP - For a black and white image.

- 4 BPP - Assigns 1 of 16 levels of grey to each pixel.
- 8 BPP - Assigns 1 of 256 levels of grey to each pixel.



**NOTE:** The imager ignores these settings for JPEG file formats, which only support 8 BPP. TIFF file formats only support 4 BPP and 8 BPP. Selecting **1 BPP** for TIFF applies the 4 BPP option.



1 BPP (0)



4 BPP (1)

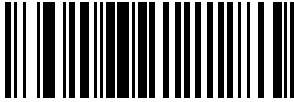

\*8 BPP (2)

## Signature Capture

### Parameter # 93 (SSI # 5Dh)

Signature capture is a special-purpose symbology that delineates a signature capture area in a document with a machine-readable format.

### Output File Format

- Enabled - Signature capture is available.
- Disabled - Signature capture is not available.

The recognition pattern is variable so it can optionally provide an index to various signatures. The region inside the barcode pattern is considered the signature capture area. See [Signature Capture Code](#) for more information.

Decoding a signature capture barcode de-skews the signature image and converts the image to a BMP, JPEG, or TIFF file format. The output data includes the file descriptor followed by the formatted signature image.

**Table 27** Output File Format

Output Format (1 byte)	File Descriptor		Signature Image
	Signature Type (1 byte)	Signature Image Size (4 bytes) (BIG Endian)	
JPEG - 1	1-8	0x00000400	0x00010203....
BMP - 3			
TIFF - 4			



Enable Signature Capture (1)

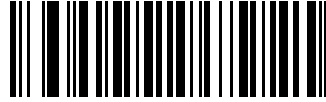

\*Disable Signature Capture (0)

## Signature Capture File Format Selector

### Parameter # 313 (SSI # F0h 39h)

This parameter de-skews the signature image and converts the image to a BMP, JPEG, or TIFF file format.

Select a signature file format appropriate for the system (BMP, TIFF, or JPEG). The imager stores captured signatures in the selected format.

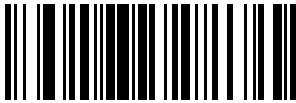

BMP Signature Format (3)

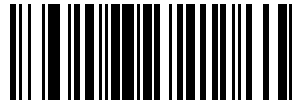

\*JPEG Signature Format (1)

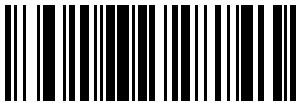

TIFF Signature Format (4)

## Signature Capture Bits Per Pixel

### Parameter # 314 (SSI # F0h 3Ah)

You can adjust the bits per pixel (BPP) when capturing a signature.

Select the number of significant bits per pixel (BPP) to use when capturing a signature:

- 1 BPP - For a black and white image.
- 4 BPP - Assigns 1 of 16 levels of grey to each pixel.
- 8 BPP - Assigns 1 of 256 levels of grey to each pixel.



**NOTE:** The imager ignores these settings for JPEG file formats, which only support 8 BPP.

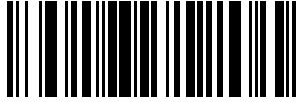

1 BPP (0)



4 BPP (1)

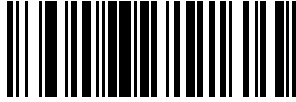

\*8 BPP (2)

## Signature Capture Width

### Parameter # 366 (SSI # F4h F0h 6Eh)

This parameter adjusts the width of a signature capture box.



**NOTE:** The aspect ratio of the Signature Capture Width and Signature Capture Height parameters must match that of the signature capture area. For example, a 4 x 1 inch signature capture area requires a 4 to 1 aspect ratio of width to height.

To set the width of the signature capture box, scan Signature Capture Width, and then scan four barcodes from [Numeric Barcodes](#) corresponding to a value in the range of 016 to 1280 decimal.



Signature Capture Width (Default: 400) (016 - 1280  
Decimal)

## Signature Capture Height

### Parameter # 367 (SSI # F4h F0h 6Fh)

This parameter adjusts the height of a signature capture box.

To set the height of the signature capture box, scan Signature Capture Height, and then scan three barcodes from [Numeric Barcodes](#) corresponding to a value in the range of 016 to 800 decimal.

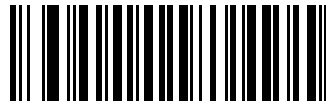

Signature Capture Height (Default: 100) (016 - 800  
Decimal)

## Signature Capture JPEG Quality

### Parameter # 421 (SSI # F0h A5h)

This parameter adjusts the image quality for a signature capture JPEG.

Scan JPEG Quality Value, and then scan three barcodes from [Numeric Barcodes](#) corresponding to a value from 005 to 100, where 100 represents the highest quality image.



JPEG Quality Value (Default: 065) (5 - 100 Decimal)

## Video View Finder

### Parameter # 324 (SSI # F0h 44h)

This parameter projects the video viewfinder while in Snapshot mode.

- Enabled - Projects the video viewfinder.
- Disabled - Does not project the video viewfinder.

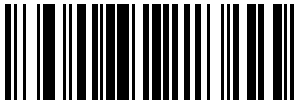

Enable Video View Finder (1)



\*Disable Video View Finder (0)

## Video View Finder Image Size

### Parameter # 329 (SSI # F0h 49h)

This parameter adjusts the video viewfinder image size by 100-byte block increments.



**NOTE:** Values range from 800 to 12,000 bytes. A smaller value transmits more frames per second, while a larger value increases video quality.

Scan Video View Finder Image Size and then scan three barcodes from [Numeric Barcodes](#) corresponding to the 100-byte value from 800 to 12,000 bytes. For example, to select 1500 bytes, enter 0, 1, 5. To select 900 bytes, enter 0, 0, 9. The default is 1700 bytes.



Video View Finder Image Size

# Signature Capture Code

CapCode, a signature capture code, is a special pattern that encloses a signature area on a document and allows a scanner to capture a signature.

There are several accepted patterns that allow automatic identification of different signatures on the same form. For example, on the federal tax return 1040 form there are three signature areas, one each for two joint filers, and one for a professional preparer. By using different patterns, a program can correctly identify all three, so they can be captured in any sequence and still be identified correctly.

## Code Structure

This section provides details on CapCode and the signature capture box.

### Signature Capture Area

A CapCode is printed as two identical patterns on either side of a signature capture box.

Each pattern extends the full height of the signature capture box. For an example, see [the figure below](#).

The box is optional, so you can omit it, replace it with a single baseline, or print a baseline with an "X" on top of it towards the left, as is customarily done in the US to indicate a request for signature. However, if an "X" or other markings are added in the signature box area, these are captured with the signature.

**Figure 10** CapCode



### CapCode Pattern Structure

A CapCode pattern structure consists of a start pattern followed by a separator space, a signature capture box, a second separator space, and then a stop pattern. Assuming that X is the dimension of the thinnest element, the start and stop patterns each contains 9X total width in 4 bars and 3 spaces. A 7X quiet zone is required to the left and to the right of the CapCode pattern.

**Figure 11** CapCode Structure

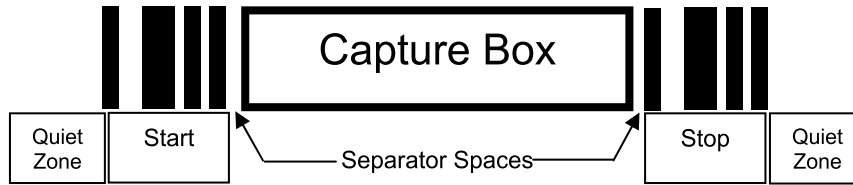

The separator spaces on either side of the signature capture box can be between 1X and 3X wide.

## Start / Stop Patterns

This section lists the accepted start / stop patterns. The bar and space widths are expressed as multiples of X.

You must use the same pattern on either side of a signature capture box. The type value is reported with the captured signature to indicate the purpose of the signature captured.

**Table 28** Start / Stop Pattern Definitions

Bar/Space Patterns							Type
B	S	B	S	B	S	B	
1	1	2	2	1	1	1	2
1	2	2	1	1	1	1	5
2	1	1	2	1	1	1	7
2	2	1	1	1	1	1	8
3	1	1	1	1	1	1	9

[Table 29 User Defined CapCode Parameters](#) on page 200 lists selectable parameters used to generate the image of the captured signature.

**Table 29** User Defined CapCode Parameters

Parameter	Defined
Width	Number of pixels
Height	Number of pixels
Format	JPEG, BMP, TIFF
JPEG quality	1 (most compression) to 100 (best quality)
Bits Per Pixel (not applicable to JPEG format)	1 (2 levels)
	4 (16 levels)
	8 (256 levels)

BMP format does not use compression, JPEG and TIFF formats do.



## Dimensions

The size of the signature capture box is determined by the height and separation of the start and stop patterns. The line width of the signature capture box is insignificant.

The thinnest element width, referred to here as *X*, is nominally 10 mils (1 mil = 0.0254 mm). Select this as an exact multiple of the pixel pitch of the printer used. For example, when using a 203 DPI (dots-per-inch) printer and printing 2 dots per module, the resulting *X* dimension is 9.85 mils.

## Data Format

Zebra decoders allow different user options to output or inhibit barcode type. Selecting "Symbol ID" as the barcode type for output identifies the CapCode with letter "i".

The decoder output is formatted according to the following table.

**Table 30** Data Format

File Format (1 byte)	Type (1 byte)	Image Size (4 bytes, BIG Endian)	Image Data
JPEG - 1 BMP - 3 TIFF - 4	See <a href="#">Table 28 Start / Stop Pattern Definitions</a> on page 200, last column		(Same bytes as in a data file)

## Additional Capabilities

Regardless of how the signature is captured, the output signature image is de-skewed and right-side up.

A scanner that captures signatures automatically determines whether it is scanning a signature or a barcode. You can disable the signature capturing capability in a decoder.

## Signature Boxes

This section illustrates the five acceptable signature boxes:

**Figure 12** Acceptable Signature Boxes

Type 2:



Type 5:



Type 7:



Type 8:



Type 9:



# Symbologies

You can program the scanner to perform various functions or activate different features.

This section describes symbology features and provides programming barcodes for selecting these features.

The scanner ships with the settings shown in the . If the default values suit requirements, programming is not necessary.

## Symbologies

Change these values in one of two ways:

- Choose the appropriate parameter in this section. The new value replaces the standard default value in memory. To recall the default parameter values, see [Default Parameters](#) on page 128.
- Configure the scanner using the 123Scan configuration program. See [123Scan and Software Tools](#).

**Table 31** Symbology Parameter Defaults

Parameter	Parameter Number <sup>a</sup>	SSI Number <sup>b</sup>	Default
Enable/Disable All Code Types			
1D Symbologies			
UPC/EAN/JAN			
UPC-A	1	01h	Enable
UPC-E	2	02h	Enable
UPC-E1	12	0Ch	Disable
EAN-8/JAN 8	4	04h	Enable
EAN-13/JAN 13	3	03h	Enable
Bookland EAN	83	53h	Disable
Bookland ISBN Format	576	F1h 40h	ISBN-10
ISSN EAN	617	F1h 69h	Disable
Decode UPC/EAN/JAN Supplementals (2 and 5 digits)	16	10h	Ignore

## Symbologies

**Table 31** Symbology Parameter Defaults (Continued)

Parameter	Parameter Number <sup>a</sup>	SSI Number <sup>b</sup>	Default
User-Programmable Supplementals Supplemental 1: Supplemental 2:	579580	F4h F1h 43h F4h H1h 44h	000
UPC/EAN/JAN Supplemental Redundancy	80	50h	10
UPC/EAN/JAN Supplemental AIM ID	672	F1h A0h	Combined
Transmit UPC-A Check Digit	40	28h	Enable
Transmit UPC-E Check Digit	41	29h	Enable
Transmit UPC-E1 Check Digit	42	2Ah	Enable
UPC-A Preamble	34	22h	System Character
UPC-E Preamble	35	23h	System Character
UPC-E1 Preamble	36	24h	System Character
Convert UPC-E to UPC-A	37	25h	Disable
Convert UPC-E1 to UPC-A	38	26h	Disable
EAN/JAN Zero Extend	39	27h	Disable
UCC Coupon Extended Code	85	55h	Disable
Coupon Report	730	F1h DAh	New Coupon Format
UPC Reduced Quiet Zone	1289	F8h 05h 09h	Disable
<b>Code 128</b>			
Code 128	8	08h	Enable
Set Length(s) for Code 128	209, 210	D1h, D2h	1 to 55
GS1-128 (formerly UCC/EAN-128)	14	0Eh	Enable
ISBT 128	84	54h	Enable
ISBT Concatenation	577	F1h 41h	Disable
Check ISBT Table	578	F1h 42h	Enable
ISBT Concatenation Redundancy	223	DFh	10
Ignore Code 128	1254	F8h 04h E6h	Disable
Code 128 Security Level	751	F1h EFh	Security Level 1
Code 128 Reduced Quiet Zone	1208	F8h 04h B8h	Disable
<b>Code 39</b>			
Code 39	0	00h	Enable
Trioptic Code 39	13	0Dh	Disable
Convert Code 39 to Code 32	86	56h	Disable
Code 32 Prefix	231	E7h	Disable
Set Length(s) for Code 39	18, 19	12h, 13h	1 to 55

## Symbologies

**Table 31** Symbology Parameter Defaults (Continued)

Parameter	Parameter Number <sup>a</sup>	SSI Number <sup>b</sup>	Default
Code 39 Check Digit Verification	48	30h	Disable
Transmit Code 39 Check Digit	43	2Bh	Disable
Code 39 Full ASCII Conversion	17	11h	Disable
Code 39 Security Level	750	F1h EEh	Security Level 1
Code 39 Reduced Quiet Zone	1209	F8h 04h B9h	Disable
Code 93			
Code 93	9	09h	Enable
Set Length(s) for Code 93	26, 27	1Ah, 1Bh	1 to 55
Code 11			
Code 11	10	0Ah	Disable
Set Lengths for Code 11	28, 29	1Ch, 1Dh	4 to 55
Code 11 Check Digit Verification	52	34h	Disable
Transmit Code 11 Check Digit(s)	47	2Fh	Disable
Interleaved 2 of 5 (ITF)			
Interleaved 2 of 5 (ITF)	6	06h	Enable
Set Lengths for I 2 of 5	22, 23	16h, 17h	6 to 55
I 2 of 5 Check Digit Verification	49	31h	Disable
Transmit I 2 of 5 Check Digit	44	2Ch	Disable
Convert I 2 of 5 to EAN 13	82	52h	Disable
I 2 of 5 Security Level	1121	F8h 04h 61h	Security Level 1
I 2 of 5 Reduced Quiet Zone	1210	F8h 04h BAh	Disable
Discrete 2 of 5 (DTF)			
Discrete 2 of 5	5	05h	Disable
Set Length(s) for D 2 of 5	20, 21	14h 15h	1 to 55
Codabar (NW - 7)			
Codabar	7	07h	Enable
Set Lengths for Codabar	24, 25	18h, 19h	4 to 55
CLSI Editing	54	36h	Disable
NOTIS Editing	55	37h	Disable
Codabar Security Level	1776	F8h 06h F0h	Security Level 1
Codabar Upper or Lower Case Start/ Stop Characters Detection	855	F2h 57h	Upper Case
Codabar Mod 16 Check Digit Verification	1784	F8h 06h F8h	Disable

**Table 31** Symbology Parameter Defaults (Continued)

Parameter	Parameter Number <sup>a</sup>	SSI Number <sup>b</sup>	Default
Transmit Codabar Check Digit	704	F1h C0h	Disable
MSI			
MSI	11	0Bh	Disable
Set Length(s) for MSI	30, 31	1Eh, 1Fh	4 to 55
MSI Check Digits	50	32h	One
Transmit MSI Check Digit	46	2Eh	Disable
MSI Check Digit Algorithm	51	33h	Mod 10/Mod 10
Chinese 2 of 5			
Chinese 2 of 5	408	F0h 98h	Disable
Matrix 2 of 5			
Matrix 2 of 5	618	F1h 6Ah	Disable
Set Lengths for Matrix 2 of 5	619 620	F1h 6Bh F1h 6Ch	4 to 55
Matrix 2 of 5 Check Digit	622	F1h 6Eh	Disable
Transmit Matrix 2 of 5 Check Digit	623	F1h 6Fh	Disable
Korean 3 of 5			
Korean 3 of 5	581	F1h 45h	Disable
Inverse 1D	586	F1h 4Ah	Regular
GS1 DataBar			
GS1 DataBar Omnidirectional	338	F0h 52h	Enable
GS1 DataBar Limited	339	F0h 53h	Enable
GS1 DataBar Expanded	340	F0h 54h	Enable
Convert GS1 DataBar to UPC/EAN/JAN	397	F0h 8Dh	Disable
GS1 DataBar Limited Margin Check	728	F1h D8h	Level 3
GS1 DataBar Security Level	1706	F8h 06h AAh	Security Level 1
Symbology-Specific Security Features			
Redundancy Level	78	4Eh	1
Security Level	77	4Dh	1
1D Quiet Zone Level	1288	F8h 05h 08h	1
Intercharacter Gap Size	381	F0h 7Dh	Normal
Composite Codes			
Composite CC-C	341	F0h 55h	Disable
Composite CC-A/B	342	F0h 56h	Disable

## Symbologies

**Table 31** Symbology Parameter Defaults (Continued)

Parameter	Parameter Number <sup>a</sup>	SSI Number <sup>b</sup>	Default
Composite TLC-39	371	F0h 73h	Disable
Composite Inverse	1113	F8h 04h 59h	Regular
UPC Composite Mode	344	F0h 58h	UPC Never Linked
Composite Beep Mode	398	F0h 8Eh	Beep As Each Code Type is Decoded
GS1-128 Emulation Mode for UCC/EAN Composite Codes	427	F0h ABh	Disable
2D Symbologies			
PDF417	15	0Fh	Enable
MicroPDF417	227	E3h	Disable
Code 128 Emulation	123	7Bh	Disable
Data Matrix	292	F0h 24h	Enable
GS1 Data Matrix	1336	F8h 05h 38h	Disable
Data Matrix Inverse	588	F1h 4Ch	Inverse Autodetect
Maxicode	294	F0h 26h	Disable
QR Code	293	F0h 25h	Enable
GS1 QR	1343	F8h 05h 3Fh	Disable
MicroQR	573	F1h 3Dh	Enable
Linked QR Mode	1847	737h	Linked QR Only
Aztec	574	F1h 3Eh	Enable
Aztec Inverse	589	F1h 4Dh	Inverse Autodetect
Han Xin	1167	F8h 04h 8Fh	Disable
Han Xin Inverse	1168	F8h 04h 90h	Regular
Grid Matrix Codes			
Grid Matrix	1718	F8 06h B6h	Disable
Grid Matrix Inverse	1719	F8h 06h B7h	Regular
Grid Matrix Mirrored	1736	F8h 06h C8h	Non-Mirrored
DotCode Codes			
DotCode	1906	F8 07 72h	Disable
DotCode Inverse	1907	F8 07 73h	Autodetect
DotCode Mirrored	1908	F8 07 74h	Autodetect
DotCode Prioritize	1937	F8 07 91h	Disable
DotCode Erasure Limit	2063	F8 08 0F	10
Postal Codes			

**Table 31** Symbology Parameter Defaults (Continued)

Parameter	Parameter Number <sup>a</sup>	SSI Number <sup>b</sup>	Default
US Postnet	89	59h	Disable
US Planet	90	5Ah	Disable
Transmit US Postal Check Digit	95	5Fh	Enable
UK Postal	91	5Bh	Disable
Transmit UK Postal Check Digit	96	60h	Enable
Japan Postal	290	F0h 22h	Disable
Australia Post	291	F0h 23h	Disable
Australia Post Format	718	F1h CEh	Autodiscriminate
Netherlands KIX Code	326	F0h 46h	Disable
USPS 4CB/One Code/Intelligent Mail	592	F1h 50h	Disable
UPU FICS Postal	611	F1h 63h	Disable
Mailmark	1337	F8h 05h 39h	Disable
Flush Macro PDF Buffer	N/A	N/A	N/A

<sup>a</sup> Parameter number decimal values are used for programming via RSM commands.

<sup>b</sup> SSI number hex values are used for programming via SSI commands.

## Enable/Disable All Code Types

- Disable All Code Types - Disable all symbologies. This is useful when enabling only a few code types.
- Enable All Code Types - Enable all symbologies. This is useful if you need to disable only a few code types.



Disable All Code Types



Enable All Code Types

## UPC/EAN/JAN

You can choose one of these parameters to enable UPC, EAN, or JAN settings.



## UPC-A

### Parameter # 1 (SSI #01h)

This parameter enables or disables UPC-A.

- \*Enabled - enables UPC-A.
- Disabled - disables UPC-A.



\*Enable UPC-A (1)

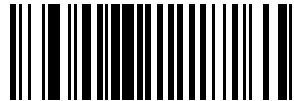

Disable UPC-A (0)

## UPC-E

### Parameter # 2 (SSI # 02h)

This parameter enables UPC-E.

- \*Enabled - this sets UPC-E to use.
- Disabled - UPC-E is no longer in use.

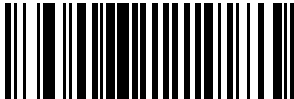

\*Enable UPC-E (1)

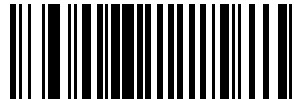

Disable UPC-E (0)

## UPC-E1

### Parameter # 12 (SSI # 0Ch)

This parameter enables UPC-E1.

- Enabled - This sets UPC-E1 to use.
- Disabled - UPC-E1 is no longer in use.



**NOTE:** UPC-E1 is not a UCC (Uniform Code Council) approved symbology.

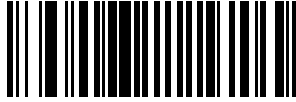

Enable UPC-E1 (1)

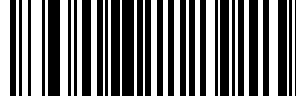

\*Disable UPC-E1 (0)

## EAN-8/JAN-8

### Parameter # 4 (SSI # 04h)

This parameter enables EAN-8/JAN-8.

- Enabled - Sets EAN-8/JAN-8 for use.
- Disabled - EAN-8/JAN-8 is no longer in use.

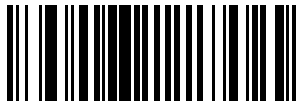

\*Enable EAN-8/JAN-8 (1)

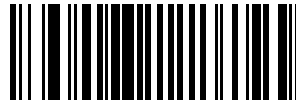

Disable EAN-8/JAN-8 (0)

## EAN-13/JAN-13

### Parameter # 3 (SSI # 03h)

This parameter enables EAN-13/JAN-13.

- Enabled - Sets EAN-13/JAN-13 for use.
- Disabled - EAN-13/JAN-13 is no longer in use.

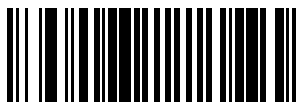

\*Enable EAN-13/JAN-13 (1)

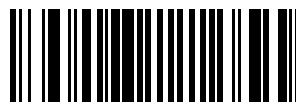

Disable EAN-13/JAN-13 (0)

## Bookland EAN

### Parameter # 83 (SSI # 53h)

This parameter enables Bookland EAN.

- Enabled - This sets Bookland EAN for use.
- Disabled - Bookland EAN is no longer in use.



**NOTE:** If you enable Bookland EAN, select a [Bookland ISBN Format](#). Also set [Decode UPC/EAN/JAN Supplementals](#) to either Decode UPC/EAN/JAN with Supplementals Only, Autodiscriminate UPC/EAN/JAN With Supplementals, or Enable 978/979 Supplemental Mode.

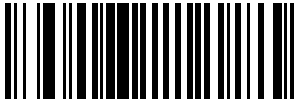

Enable Bookland EAN (1)

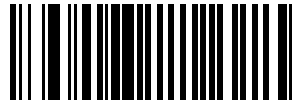

\*Disable Bookland EAN (0)

## Bookland ISBN Format

### Parameter # 576 (SSI # F1h 40h)

If Bookland EAN is enabled, this parameter allows you to choose a format for Bookland data.

- \*Bookland ISBN-10 - The scanner reports Bookland data starting with 978 in traditional 10-digit format with the special Bookland check digit for backward-compatibility. Data starting with 979 is not considered Bookland in this mode.
- Bookland ISBN-13 - The scanner reports Bookland data (starting with either 978 or 979) as EAN-13 in 13-digit format to meet the 2007 ISBN-13 protocol.



**NOTE:** For Bookland EAN to function properly, first enable [Bookland EAN](#) and then set [Decode UPC/EAN/JAN Supplementals](#) to either Decode UPC/EAN/JAN with Supplementals Only, Autodiscriminate UPC/EAN/JAN With Supplementals, or Enable 978/979 Supplemental Mode.

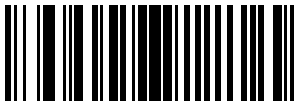

\*Bookland ISBN-10 (0)

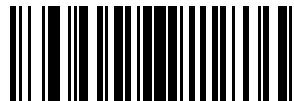

Bookland ISBN-13 (1)

## ISSN EAN

### Parameter # 617 (SSI # F1h 69h)

This parameter enables ISSN EAN.

- Enabled - Sets ISSN EAN for use.
- \*Disabled - ISSN EAN is no longer in use.

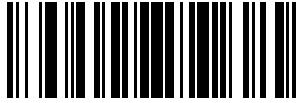

Enable ISSN EAN (1)



\*Disable ISSN EAN (0)

## Decode UPC/EAN/JAN Supplementals

### Parameter # 16 (SSI # 10h)

This parameter decodes supplementals, which are barcodes appended according to specific format conventions (for example, UPC A+2, UPC E+2, EAN 13+2).

- Decode UPC/EAN/JAN with Supplementals Only - The scanner only decodes UPC/EAN/JAN symbols with supplemental characters, and ignores symbols without supplementals.
- Ignore UPC/EAN/JAN Supplementals - When presented with a UPC/EAN/JAN plus supplemental symbol, the scanner decodes UPC/EAN/JAN and ignores the supplemental characters.
- Autodiscriminate UPC/EAN/JAN with Supplementals - The scanner decodes UPC/EAN/JAN symbols with supplemental characters immediately. If the symbol does not have a supplemental, the scanner must decode the barcode the number of times set via [UPC/EAN/JAN Supplemental Redundancy](#) before transmitting its data to confirm that there is no supplemental.
- Enable 378/379 Supplemental Mode
- Enable 978/979 Supplemental Mode



**NOTE:** If you select 978/979 Supplemental Mode and are scanning Bookland EAN barcodes, see [Bookland EAN](#), and select a format using [Bookland ISBN Format](#).

- Enable 977 Supplemental Mode
- Enable 414/419/434/439 Supplemental Mode
- Enable 491 Supplemental Mode
- Enable Smart Supplemental Mode - This applies to EAN-13 barcodes starting with any prefix listed previously.
- Supplemental User-Programmable Type 1 - This applies to EAN-13 barcodes starting with a 3-digit user-defined prefix. Set this using [User Programmable Supplementals](#).
- Supplemental User-Programmable Type 1 and 2 - This applies to EAN-13 barcodes starting with either of two 3-digit user-defined prefixes. Set the prefixes using [User Programmable Supplementals](#).
- Smart Supplemental Plus User-Programmable 1 - This applies to EAN-13 barcodes starting with any prefix listed previously or the prefix set using [User Programmable Supplementals](#).

- Smart Supplemental Plus User-Programmable 1 and 2 - This applies to EAN-13 barcodes starting with any prefix listed previously or one of the two user-defined prefixes set using [User Programmable Supplementals](#).



**NOTE:** To minimize the risk of invalid data transmission, select either to decode or ignore supplemental characters.

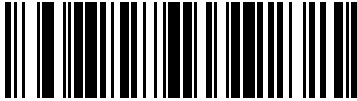

Decode UPC/EAN/JAN With Supplementals Only (1)



\*Ignore UPC/EAN/JAN Supplementals (0)

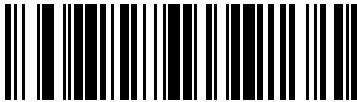

Autodiscriminate UPC/EAN/JAN with Supplementals (2)

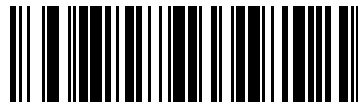

Enable 378/379 Supplemental Mode (4)



Enable 978/979 Supplemental Mode (5)



Enable 977 Supplemental Mode (7)



Enable 414/419/434/439 Supplemental Mode (6)



Enable 491 Supplemental Mode (8)



Enable Smart Supplemental Mode (3)



Supplemental User-Programmable Type 1 (9)

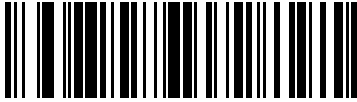

Supplemental User-Programmable Type 1 and 2 (10)

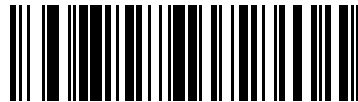

Smart Supplemental Plus User-Programmable 1 (11)

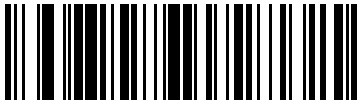

Smart Supplemental Plus User-Programmable 1 and 2 (12)

## User-Programmable Supplementals

**Parameter # 579 (SSI # F4h F1h 43h)**

**Parameter # 580 (SSI # F4h F1h 44h)**

If you selected a Supplemental User-Programmable option, this parameter allows you to set two 3-digit prefixes.

- User-Programmable Supplemental 1 - Sets the first 3-digit prefix. See [Numeric Barcodes](#).
- User-Programmable Supplemental 2 - Sets a 2nd 3-digit prefix, if necessary. See [Numeric Barcodes](#).



User-Programmable Supplemental 1



User-Programmable Supplemental 2

## UPC/EAN/JAN Supplemental Redundancy

### Parameter # 80 (SSI # 50h)

If you selected Autodiscriminate UPC/EAN/JAN with Supplementals, this option sets the number of times to decode a symbol without supplementals before transmission. You can enable audio feedback during a reconnect attempt.

The range is from 2-30. Five or above is recommended when decoding a mix of UPC/EAN/JAN symbols with and without supplementals.

To set a redundancy value, scan the following barcode, and then scan two barcodes from [Numeric Barcodes](#). Enter a leading zero for single digit numbers. To correct an error or change a selection, scan [Cancel](#).

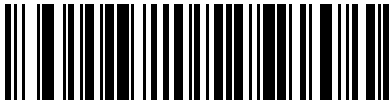

UPC/EAN/JAN Supplemental Redundancy

## UPC/EAN/JAN Supplemental AIM ID Format

### Parameter # 672 (SSI # F1h A0h)

If Transmit Code ID Character is set to **AIM Code ID Character**, select an output format when reporting UPC/EAN/JAN barcodes with supplementals.

- Separate - Transmit UPC/EAN/JAN with supplementals with separate AIM IDs but one transmission, for example,

```
]E<0 or 4><data>]E<1 or 2>[supplemental data]
```

- Combined - Transmit UPC/EAN/JAN with supplementals with one AIM ID and one transmission. For example, see below.

```
]E3<data+supplemental data>
```

- Separate Transmissions - Transmit UPC/EAN/JAN with supplementals with separate AIM IDs and separate transmissions, for example,

```
]E<0 or 4><data>
]E<1 or 2>[supplemental data]
```

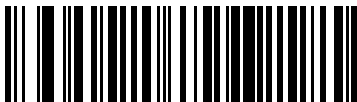

Separate (0)

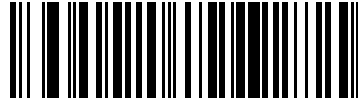

\*Combined (1)



Separate Transmissions (2)

## Transmit UPC-A Check Digit

### Parameter # 40 (SSI # 28h)

This parameter transmits data with or without the UPC-A check digit.

The check digit is the last character of the symbol used to verify the integrity of the data. It is always verified to guarantee the integrity of the data.

- \*Transmit UPC-A Check Digit - Transmits the data with the UPC-A check digit.
- Do Not Transmit UPC-A Check Digit - Transmits the data without the UPC-A check digit.

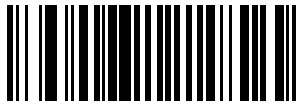

\*Transmit UPC-A Check Digit (1)

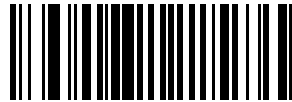

Do Not Transmit UPC-A Check Digit (0)

## Transmit UPC-E Check Digit

### Parameter # 41 (SSI # 29h)

This parameter transmits data with or without the UPC-E check digit.

The check digit is the last character of the symbol used to verify the integrity of the data. It is always verified to guarantee the integrity of the data.

- \*Transmit UPC-E Check Digit - transmits the data with the UPC-E check digit.
- Do Not Transmit UPC-E Check Digit - transmits the data without the UPC-E check digit.



\*Transmit UPC-E Check Digit (1)



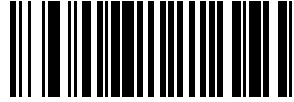

Do Not Transmit UPC-E Check Digit (0)

## Transmit UPC-E1 Check Digit

### Parameter # 42 (SSI #2Ah)

This parameters transmits data with or without the UPC-E1 check digit.

The check digit is the last character of the symbol used to verify the integrity of the data. It is always verified to guarantee the integrity of the data.

- \*Transmit UPC-E1 Check Digit - Transmits the data with the UPC-E1 check digit.
- Do Not Transmit UPC-E1 Check Digit - Transmits the data without the UPC-E1 check digit.

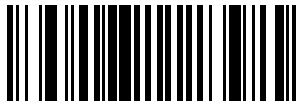

\*Transmit UPC-E1 Check Digit (1)

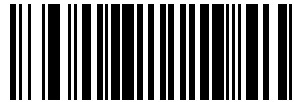

Do Not Transmit UPC-E1 Check Digit (0)

## UPC-A Preamble

### Parameter # 34 (SSI # 22h)

Preamble characters are part of the UPC symbol, and include Country Code and System Character.

Select the appropriate option for transmitting a UPC-A preamble to match the host system:

- Transmit System Character only
- Transmit System Character and Country Code ("0" for USA)
- Transmit no preamble.

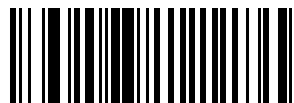

No Preamble (&lt;DATA&gt;) (0)

\*System Character (<SYSTEM CHARACTER>  
<DATA>) (1)



System Character & Country Code (< COUNTRY CODE> <SYSTEM CHARACTER> <DATA>) (2)

## UPC-E Preamble

### Parameter # 35 (SSI # 23h)

Preamble characters are part of the UPC symbol, and include Country Code and System Character.

Select the appropriate option for transmitting a UPC-E preamble to match the host system:

- Transmit System Character only
- Transmit System Character and Country Code (“0” for USA)
- Transmit no preamble.

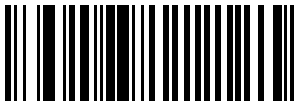

No Preamble (<DATA>) (0)



\*System Character (<SYSTEM CHARACTER> <DATA>) (1)

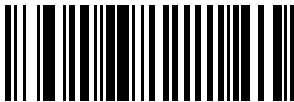

System Character & Country Code (< COUNTRY CODE> <SYSTEM CHARACTER> <DATA>) (2)

## UPC-E1 Preamble

### Parameter # 36 (SSI # 24h)

Preamble characters are part of the UPC symbol, and include Country Code and System Character.

Select the appropriate option for transmitting a UPC-E1 preamble to match the host system:

- Transmit System Character only
- Transmit System Character and Country Code (“0” for USA)
- Transmit no preamble.

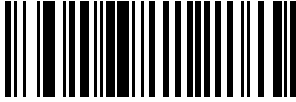

No Preamble (<DATA>) (0)



\*System Character (<SYSTEM CHARACTER>  
<DATA>) (1)

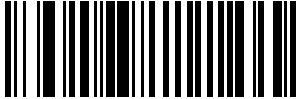

System Character & Country Code (< COUNTRY  
CODE> <SYSTEM CHARACTER> <DATA>) (2)

## Convert UPC-E to UPC-A

### Parameter # 37 (SSI # 25h)

This parameter converts UPC-E (zero suppressed) decoded data to UPC-A format before transmission.

After conversion, the data follows UPC-A format and is affected by UPC-A programming selections (such as, Preamble, Check Digit).

- \*Enabled - Converts UPC-E decoded data to UPC-A format.
- Disabled - Transmits UPC-E decoded data without conversion to UPC-A.

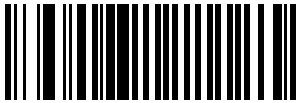

Convert UPC-E to UPC-A (Enable) (1)

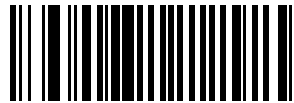

\*Do Not Convert UPC-E to UPC-A (Disable) (0)

## Convert UPC-E1 to UPC-A

### Parameter # 38 (SSI # 26h)

This parameter converts UPC-E1 (zero suppressed) decoded data to UPC-A format before transmission.

After conversion, the data follows UPC-A format and is affected by UPC-A programming selections (for example, Preamble, Check Digit).

- \*Enabled - converts UPC-E1 decoded data to UPC-A format.
- Disabled - transmits UPC-E1 decoded data without conversion to UPC-A.

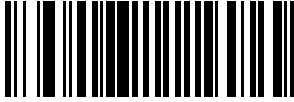

Convert UPC-E1 to UPC-A (Enable) (1)

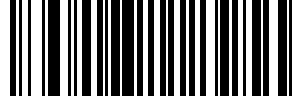

\*Do Not Convert UPC-E1 to UPC-A (Disable) (0)

## EAN/JAN Zero Extend

### Parameter # 39 (SSI # 27h)

This parameter enables or disables decoded EAN-8 symbols to be compatible in length with EAN-13 symbols.

- Enabled - Adds five leading zeros to decoded EAN-8 symbols to make them compatible in length to EAN-13 symbols
- Disabled - Transmits EAN-8 symbols as-is, without adding zeroes.

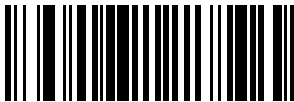

Enable EAN/JAN Zero Extend (1)

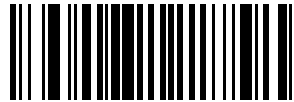

\*Disable EAN/JAN Zero Extend (0)

## UCC Coupon Extended Code

### Parameter # 85 (SSI # 55h)

This parameter decodes UPC-A barcodes starting with digit '5', EAN-13 barcodes starting with digit '99', and UPC-A/GS1-128 coupon codes.

- Enabled - Extends decoding for UPC-A, EAN-13, and GS1-128 coupon codes.
- \*Disabled - Does not extend decoding for UPC-A, EAN-13, and GS1-128 coupon codes.



**NOTE:** UPC-A, EAN-13, and GS1-128 must be enabled to use this feature.



**NOTE:** See [UPC/EAN/JAN Supplemental Redundancy](#) to control autodiscrimination of the GS1-128 portion (right half) of a coupon code.

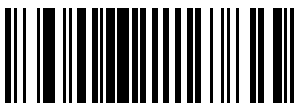

Enable UCC Coupon Extended Code (1)

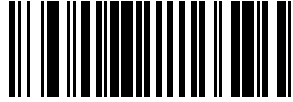

\*Disable UCC Coupon Extended Code (0)

## Coupon Report

### Parameter # 730 (SSI # F1h DAh)

This parameter selects the type of coupon format to support.

- Old Coupon Format - Support UPC-A/GS1-128 and EAN-13/GS1-128.
- New Coupon Format - An interim format to support UPC-A/GS1-DataBar and EAN-13/GS1-DataBar.
- Autodiscriminate Format - Support both Old Coupon Format and New Coupon Format.



Old Coupon Format (0)

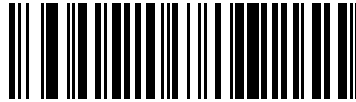

\*New Coupon Format (1)



Autodiscriminate Coupon Format (2)

## UPC Reduced Quiet Zone

### Parameter # 1289 (SSI # F8h 05h 09h)

This parameter enables or disables decoding UPC barcodes with reduced quiet zones (the margins on either side of the barcode).

- Enabled - Enables decoding UPC barcodes with reduced quiet zones.
- \*Disabled - Disables decoding UPC barcodes with reduced quiet zones.



**NOTE:** If you select Enable, select a [1D Quiet Zone Level](#).



Enable UPC Reduced Quiet Zone (1)

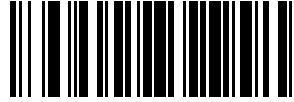

\*Disable UPC Reduced Quiet Zone (0)

## Code 128

### Parameter # 8 (SSI #08h)

You can enable or disable Code 128.

- \*Enabled - Enables Code 128.
- Disabled - Disables Code 128.

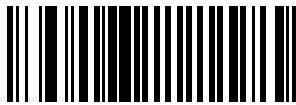

\*Enable Code 128 (1)

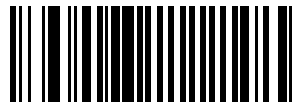

Disable Code 128 (0)

## Set Lengths for Code 128

### Parameter # 209 (SSI #D1h)

### Parameter # 210 (SSI #D2h)

This parameter sets lengths for Code 128 to any length, one or two discrete lengths, or lengths within a specific range.

The length of a code refers to the number of characters (for example, human-readable characters), including check digit(s) the code contains. The default is Any Lengthd.



**NOTE:** When setting lengths, enter a leading zero for single digit numbers.

- One Discrete Length - Decode only Code 128 symbols containing a selected length.
- Two Discrete Lengths - Decode only Code 128 symbols containing either of two lengths.
- Length Within Range - Decode Code 128 symbols with a specific length range.
- Any Length - Decode Code 128 symbols containing any number of characters within the scanner's capability.

Select lengths using barcodes in [Numeric Barcodes](#). To correct an error or change the selection, scan [Cancel](#).

For example:

- To decode only Code 128 symbols with 14 characters, scan Code 128 - One Discrete Length, and then scan 1, 4.

- To decode only Code 128 symbols containing either 2 or 14 characters, scan Code 128 - Two Discrete Lengths, and then scan 0, 2, 1, 4.
- To decode Code 128 symbols containing between 4 and 12 characters, scan Code 128 - Length Within Range, and then scan 0, 4, 1, 2.

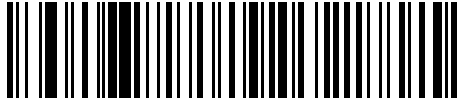

Code 128 - One Discrete Length



Code 128 - Two Discrete Lengths

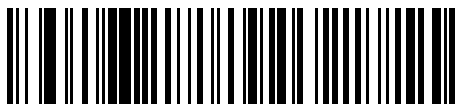

Code 128 - Length Within Range (Default: Any Lengthd )



\*Code 128 - Any Length

## GS1-128 (formerly UCC/EAN-128)

### Parameter # 14 (SSI #0Eh)

You can enable or disable GS1-128.

- \*Enabled - Enables GS1-128.
- Disabled - Disables GS1-128.



\*Enable GS1-128 (1)

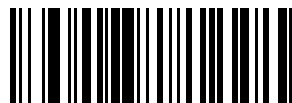

Disable GS1-128 (0)

## ISBT 128

### Parameter # 84 (SSI #54h)

You can enable or disable ISBT 128.

- \*Enabled - enables ISBT 128.
- Disabled - disables ISBT 128.

ISBT 128 is a variant of Code 128 used in the blood bank industry.

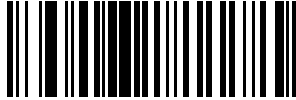

\*Enable ISBT 128 (1)

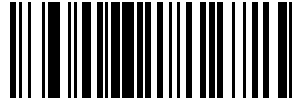

Disable ISBT 128 (0)

## ISBT Concatenation

### Parameter # 577 (SSI #F1h 41h)

This parameter enables and disables ISBT concatenation.

Select an option for concatenating pairs of ISBT code types:

- Enable ISBT Concatenation - There must be two ISBT codes in order for the scanner to decode and perform concatenation. The scanner does not decode single ISBT symbols.
- Disable ISBT Concatenation - The scanner does not concatenate pairs of ISBT codes it encounters.
- Autodiscriminate ISBT Concatenation - The scanner decodes and concatenates pairs of ISBT codes immediately. If only a single ISBT symbol is present, the scanner must decode the symbol the number of times set via [ISBT Concatenation Redundancy](#) before transmitting its data to confirm that there is no additional ISBT symbol.



**NOTE:** For ISBT AutoDetect to operate as expected, both barcodes must be in the field of view simultaneously. This may be difficult to achieve in presentation mode.



**NOTE:** When enabling ISBT Concatenation or Autodiscriminate ISBT Concatenation set Code 128 Security Level to Level 2.



Enable ISBT Concatenation (1)



\*Disable ISBT Concatenation (0)



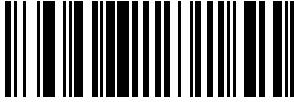

Autodiscriminate ISBT Concatenation (2)

## Check ISBT Table

### Parameter # 578 (SSI #F1h 42h)

This parameter enables or disables the Check ISBT Table to concatenate only those pairs found in this table. Other types of ISBT codes are not concatenated.

- \*Enabled - enables the Check ISBT Table to concatenate only those pairs found in this table.
- Disabled - disables the Check ISBT Table to concatenate only those pairs found in this table.

The ISBT specification includes a table that lists several types of ISBT barcodes that are commonly used in pairs.

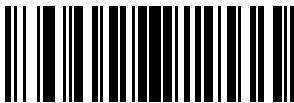

\*Enable Check ISBT Table (1)

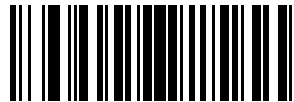

Disable Check ISBT Table (0)

## ISBT Concatenation Redundancy

### Parameter # 223 (SSI #DFh)

This parameter sets the number of times the scanner must decode an ISBT symbol before determining that there is no additional symbol.

This parameter applies if you set ISBT Concatenation to Autodiscriminate.

Scan the following barcode, and then scan barcodes in [Numeric Barcodes](#) to set a value between 2 and 20. Enter a leading zero for single-digit numbers. To correct an error or change a selection, scan [Cancel](#). The default is 10.

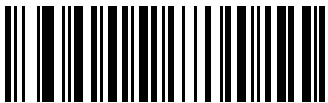

ISBT Concatenation Redundancy

## Ignore Code 128 <FNC4>

### Parameter # 1254 (SSI #F8h 04h E6h)

This feature applies to Code 128 bar codes with an embedded <FNC4> character. Enable this to strip the <FNC4> character from the decode data.

The remaining characters are sent to the host unchanged. When disabled, the <FNC4> character is processed normally as per Code 128 standard.



Enable Ignore Code 128 <FNC4> (1)

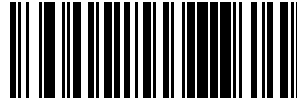

\*Disable Ignore Code 128 <FNC4> (0)

## Code 128 Security Level

### Parameter # 751 (SSI #F1h EFh)

This parameter enables four levels of decode security for Code 128.

Code 128 barcodes are vulnerable to misdecodes, particularly when Code 128 Lengths is set to Any Length. There is an inverse relationship between security and scanner aggressiveness. Increasing the level of security can reduce scanning aggressiveness, so select only the level of security necessary.

- Code 128 Security Level 0 - The scanner operates in its most aggressive state, while providing sufficient security in decoding most in-spec barcodes.
- Code 128 Security Level 1 - This option eliminates most misdecodes while maintaining reasonable aggressiveness.
- Code 128 Security Level 2 - This option applies greater barcode security requirements if Security Level 1 fails to eliminate misdecodes.
- Code 128 Security Level 3 - If you selected Security Level 2, and misdecodes still occur, select this security level to apply the highest safety requirements.



**NOTE:** Selecting Code 128 Security Level 3 is an extreme measure against mis-decoding severely out-of-spec barcodes, and significantly impairs the decoding ability of the device. If this level of security is required, try to improve the quality of the barcodes.

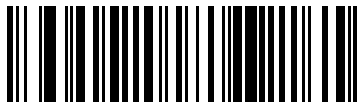

Code 128 Security Level 0 (0)



\*Code 128 Security Level 1 (1)



Code 128 Security Level 2 (2)



Code 128 Security Level 3 (3)

## Code 128 Reduced Quiet Zone

### Parameter # 1208 (SSI #F8h 04h B8h)

This parameter enables or disables decoding Code 128 with reduced quiet zones (the margins on either side of the barcode).

If you select Enable, select a [1D Quiet Zone Level](#).

- Enabled - enables Code 128 with reduced Quiet Zones.
- \*Disabled - disables Code 128 with reduced Quiet Zones.

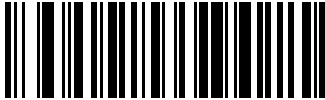

Enable Code 128 Reduced Quiet Zone (1)



\*Disable Code 128 Reduced Quiet Zone (0)

## Code 39

### Parameter # 0 (SSI #00h)

This parameter enables or disables Code 39.

- \*Enabled - Enables Code 39.
- Disabled - Disables Code 39.



\*Enable Code 39 (1)

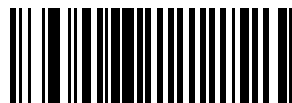

Disable Code 39 (0)

## Trioptic Code 39

### Parameter # 13 (SSI #0Dh)

This parameter enables or disables Trioptic Code 39.

Trioptic Code 39 is a variant of Code 39 used in the marking of computer tape cartridges. Trioptic Code 39 symbols always contain six characters.

- Enabled - enables Trioptic Code 39.
- \*Disabled - disables Trioptic Code 39.



**NOTE:** You cannot enable Trioptic Code 39 and Code 39 Full ASCII simultaneously.

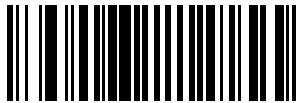

Enable Trioptic Code 39 (1)

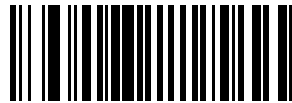

\*Disable Trioptic Code 39 (0)

## Convert Code 39 to Code 32

### Parameter # 86 (SSI #5h)

This parameter enables or disables converting Code 39 to Code 32.

Code 32 is a variant of Code 39 used by the Italian pharmaceutical industry.



**NOTE:** Code 39 must be enabled for this parameter to function.

- Enabled - enables Convert Code 39 to Code 32.
- \*Disabled - disables Convert Code 39 to Code 32.



Enable Convert Code 39 to Code 32 (1)

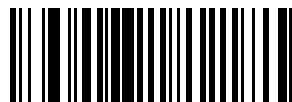

Disable Convert Code 39 to Code 32 (0)

## Code 32 Prefix

### Parameter # 231 (SSI #E7h)

This parameter enables or disables adding the prefix character “A” to all Code 32 barcodes.

- Enabled - enables Code 32 Prefix.
- \*Disabled - disables Code 32 Prefix.



**NOTE:** [Convert Code 39 to Code 32](#) must be enabled for this parameter to function.



Enable Code 32 Prefix (1)

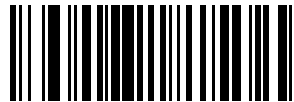

\*Disable Code 32 Prefix (0)

## Set Lengths for Code 39

L1 **Parameter # 18 (SSI #12h)**

L2 **Parameter # 19 (SSI #13h)**

This parameter sets lengths for Code 39.

The length of a code refers to the number of characters (for example, human readable characters), including check digit(s) the code contains. Set lengths for Code 39 to any length, one or two discrete lengths, or lengths within a specific range. If Code 39 Full ASCII is enabled, Length Within Range or Any Length are the preferred options. The default is 1 to 55.



**NOTE:** When setting lengths, enter a leading zero for single digit numbers.

- One Discrete Length - Decode only Code 39 symbols containing a selected length.
- Two Discrete Lengths - Decode only Code 39 symbols containing either of two lengths.
- Length Within Range - Decode Code 39 symbols with a specific length range.
- Any Length - Decode Code 39 symbols containing any number of characters within the scanner’s capability.

Select lengths using barcodes in [Numeric Barcodes](#). To correct an error or change the selection, scan [Cancel](#).

For example:

- To decode only Code 39 symbols with 14 characters, scan Code 39 - One Discrete Length, and then scan 1, 4.
- To decode only Code 39 symbols containing either 2 or 14 characters, scan Code 39 - Two Discrete Lengths, and then scan 0, 2, 1, 4.
- To decode Code 39 symbols containing between 4 and 12 characters, scan Code 39 - Length Within Range, and then scan 0, 4, 1, 2.



Code 39 - One Discrete Length



Code 39 - Two Discrete Lengths



\*Code 39 - Length Within Range (Default: 1 to 55 )

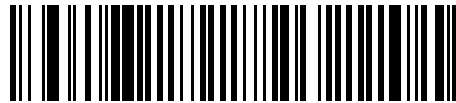

Code 39 - Any Length

## Code 39 Check Digit Verification

### Parameter # 48 (SSI #30h)

This parameter checks the integrity of all Code 39 symbols to verify that the data complies with specified check digit algorithm.

Only Code 39 symbols which include a modulo 43 check digit are decoded. Enable this feature if the Code 39 symbols contain a Modulo 43 check digit.

- Enabled - enables Code 39 Check Digit.
- \*Disabled - disables Code 39 Check Digit.



Enable Code 39 Check Digit (1)

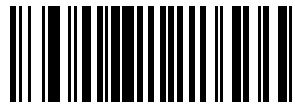

\*Disable Code 39 Check Digit (0)

## Transmit Code 39 Check Digit

### Parameter # 43 (SSI #2Bh)

This parameter transmits Code 39 data with or without the check digit.

- Enabled - enables Transmit Code 39 Check Digit.
- \*Disabled - disables Transmit Code 39 Check Digit.



**NOTE:** [Code 39 Check Digit Verification](#) must be enabled for this parameter to function.

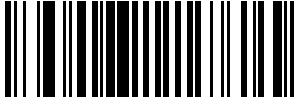

Transmit Code 39 Check Digit (Enable) (1)



\*Do Not Transmit Code 39 Check Digit (Disable) (0)

## Code 39 Full ASCII Conversion

### Parameter # 17 (SSI #11h)

This parameter enables or disables Code 39 Full ASCII.

Code 39 Full ASCII is a variant of Code 39 which pairs characters to encode the full ASCII character set.

- Enabled - enables Code 39 Full ASCII.
- \*Disabled - disables Code 39 Full ASCII.



**NOTE:** You cannot enable Trioptic Code 39 and Code 39 Full ASCII simultaneously.



**NOTE:** Code 39 Full ASCII to Full ASCII Correlation is host-dependent, and is therefore described in the ASCII character set table for the appropriate interface. See [ASCII Character Sets](#).

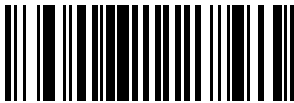

Enable Code 39 Full ASCII (1)

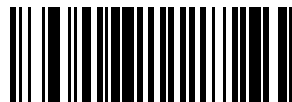

\*Disable Code 39 Full ASCII (0)

## Code 39 Security Level

### Parameter # 750 (SSI #F1h EEh)

This parameter sets the security level for Code 39.

Select increasing levels of security for decreasing levels of barcode quality. There is an inverse relationship between security, and device aggressiveness, so choose only that level of security necessary for any given application.

- Code 39 Security Level 0 - Allows the device to operate in its most aggressive state, while providing sufficient security in decoding most "in-spec" barcodes.
- \*Code 39 Security Level 1 - This setting eliminates most mis-decodes

- Code 39 Security Level 2 - Select this option if Security Level 1 fails to eliminate mis-decodes.
- Code 39 Security Level 3 - If you selected Security Level 2 and mis-decodes still occur, select this security level.



**NOTE:** Selecting Security Level 3 is an extreme measure against mis-decoding severely out of spec barcodes. Selecting this level of security significantly impairs the decoding ability of the device. If you need this level of security, try to improve the quality of the barcodes.



Code 39 Security Level 0 (0)

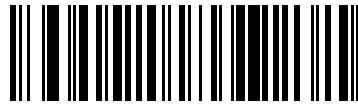

\*Code 39 Security Level 1 (1)



Code 39 Security Level 2 (2)



Code 39 Security Level 3 (3)

## Code 39 Reduced Quiet Zone

### Parameter # 1209 (SSI #F8h 04h B9h)

This parameter enables or disables decoding Code 39 with reduced quiet zones (the margins on either side of the barcode).

If you select Enable, select a [1D Quiet Zone Level](#).

- \*Enabled - enables Code 39 with reduced Quiet Zones.
- Disabled - disables Code 39 with reduced Quiet Zones.

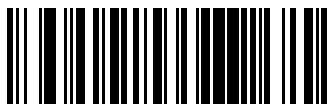

Enable Code 39 Reduced Quiet Zone (1)



Disable Code 39 Reduced Quiet Zone (0)



## Code 93

### Parameter # 9 (SSI #09h)

This parameter enables or disables Code 93.

- \*Enabled - enables Code 93.
- Disabled - disables Code 93.

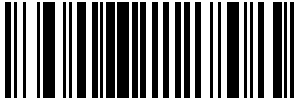

\*Enable Code 93 (1)

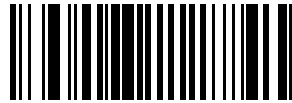

Disable Code 93 (0)

## Set Lengths for Code 93

### Parameter # 26 (SSI #1Ah)

### Parameter # 27 (SSI #1Bh)

This parameter sets the lengths for Code 93 to any length, one or two discrete lengths, or lengths within a specific range.

The length of a code refers to the number of characters (for example, human-readable characters), including check digit(s) the code contains. The default is Length Within Range: 1 to 55.



**NOTE:** When setting lengths, enter a leading zero for single-digit numbers.

- One Discrete Length - Decode only Code 93 symbols containing a selected length.
- Two Discrete Lengths - Decode only Code 93 symbols containing either of two lengths.
- Length Within Range - Decode Code 93 symbols with a specific length range.
- Any Length - Decode Code 93 symbols containing any number of characters within the scanner's capability.

Select lengths using barcodes in [Numeric Barcodes](#). To correct an error or change the selection, scan [Cancel](#).

For example:

- To decode only Code 93 symbols with 14 characters, scan Code 93 - One Discrete Length, and then scan 1, 4.
- To decode only Code 93 symbols containing either 2 or 14 characters, scan Code 93 - Two Discrete Lengths, and then scan 0, 2, 1, 4.
- To decode Code 93 symbols containing between 4 and 12 characters, scan Code 93 - Length Within Range, and then scan 0, 4, 1, 2.



Code 93 - One Discrete Length

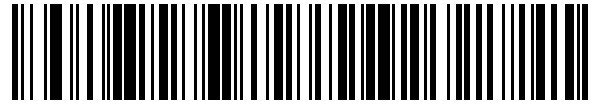

Code 93 - Two Discrete Lengths



\*Code 93 - Length Within Range (Default: )

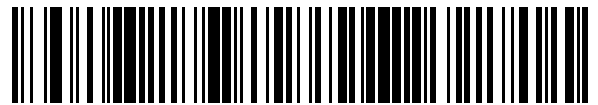

Code 93 - Any Length

## Code 11

### Parameter # 10 (SSI #0Ah)

This parameter enables or disables Code 11.

- Enabled - enables Code 11.
- \*Disabled - disables Code 11.



Enable Code 11 (1)

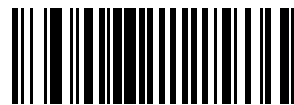

\*Disable Code 11 (0)

## Set Lengths for Code 11

### L1 Parameter # 28 (SSI #1Ch)

### L2 Parameter # 29 (SSI #1Dh)

This parameter set lengths for Code 11.

The length of a code refers to the number of characters (i.e., human readable characters), including check digit(s) the code contains. Set lengths for Code 11 to any length, one or two discrete lengths, or lengths within a specific range. The default is Length Within Range: 1 to 54.



**NOTE:** When setting lengths, enter a leading zero for single digit numbers.

- One Discrete Length - Decode only Code 11 symbols containing a selected length.
- Two Discrete Lengths - Decode only Code 11 symbols containing either of two lengths.
- Length Within Range - Decode Code 11 symbols with a specific length range.
- Any Length - Decode Code 11 symbols containing any number of characters within the scanner's capability.

Select lengths using barcodes in [Numeric Barcodes](#). To correct an error or change the selection, scan [Cancel](#).

For example:

- To decode only Code 11 symbols with 14 characters, scan Code 11 - One Discrete Length, and then scan 1, 4.
- To decode only Code 11 symbols containing either 2 or 14 characters, scan Code 11 - Two Discrete Lengths, and then scan 0, 2, 1, 4.
- To decode Code 11 symbols containing between 4 and 12 characters, scan Code 11 - Length Within Range, and then scan 0, 4, 1, 2.

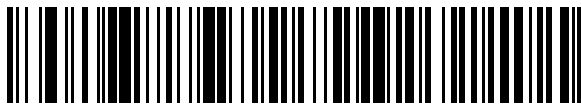

Code 11 - One Discrete Length

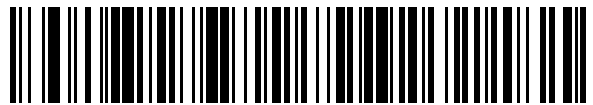

Code 11 - Two Discrete Lengths

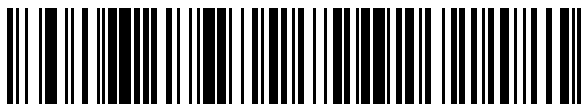

\*Code 11 - Length Within Range (Default: Any Lengthd )



Code 11 - Any Length

## Code 11 Check Digit Verification

### Parameter # 52 (SSI #34h)

This parameter checks the integrity of all Code 11 symbols to verify that the data complies with specified check digit algorithm.

- \*Disabled - disables Code 11 Check Digit.
- One Check Digit - enables Code 11 to check one digit.

- Two Check Digits - enables Code 11 to check 2 digits.

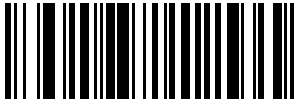

\*Disable (0)

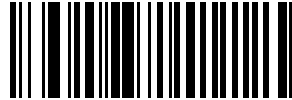

One Check Digit (1)



Two Check Digits (2)

## Transmit Code 11 Check Digits

### Parameter # 47 (SSI #2Fh)

This parameter transmits Code 11 data with or without the check digit.

- Enabled - enables Transmit Code 11 Check Digit.
- \*Disabled - disables Transmit Code 11 Check Digit.



**NOTE:** [Code 11 Check Digit Verification](#) must be enabled for this parameter to function.

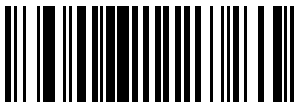

Transmit Code 11 Check Digit(s) (Enable) (1)

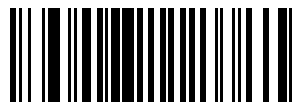

\*Do Not Transmit Code 11 Check Digit(s) (Disable)  
(0)

## Interleaved 2 of 5 (I 2 of 5)

### Parameter # 6 (SSI #06h)

This parameter enables or disables I 2 of 5.

- \*Enabled - enables I 2 of 5.
- Disabled - disables I 2 of 5.

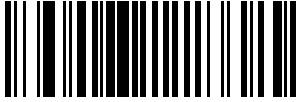

\*Enable Interleaved 2 of 5 (1)

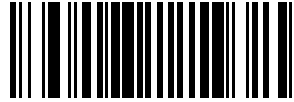

Disable Interleaved 2 of 5 (0)

## Set Lengths for Interleaved 2 of 5 (I 2 of 5)

L1 Parameter # 22 (SSI #16h)

L2 Parameter # 23 (SSI #17h)

This parameter sets lengths for I 2 of 5.

The length of a code refers to the number of characters (for example, human-readable characters), including check digit(s) the code contains. Set lengths for I 2 of 5 to any length, one or two discrete lengths, or lengths within a specific range. The default is Length Within Range: 6 to 55.



**NOTE:** When setting lengths, enter a leading zero for single digit numbers.

- One Discrete Length - Decode only I 2 of 5 symbols containing a selected length.
- Two Discrete Lengths - Decode only I 2 of 5 symbols containing either of two lengths.
- Length Within Range - Decode I 2 of 5 symbols with a specific length range.
- Any Length - Decode I 2 of 5 symbols containing any number of characters within the scanner's capability.



**NOTE:** Due to the construction of the I 2 of 5 symbology, it is possible for a scan line covering only a portion of the code to transmit as a complete scan, yielding less data than is encoded in the barcode. To prevent this, select specific lengths (I 2 of 5 - One Discrete Length, Two Discrete Lengths) for I 2 of 5 applications, or increase the [Security Level](#).

Select lengths using barcodes in [Numeric Barcodes](#). To correct an error or change the selection, scan [Cancel](#).

For example:

- To decode only I 2 of 5 symbols with 14 characters, scan I 2 of 5 - One Discrete Length, and then scan 1, 4.
- To decode only I 2 of 5 symbols containing either 2 or 14 characters, scan I 2 of 5 - Two Discrete Lengths, and then scan 0, 2, 1, 4.
- To decode I 2 of 5 symbols containing between 4 and 12 characters, scan I 2 of 5 - Length Within Range, and then scan 0, 4, 1, 2.

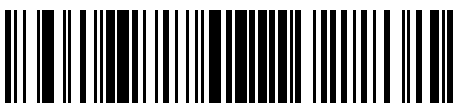

I 2 of 5 - One Discrete Length

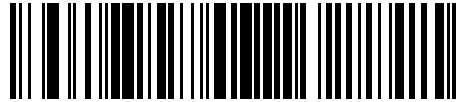

I 2 of 5 - Two Discrete Lengths

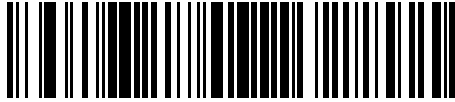

\*I 2 of 5 - Length Within Range (Default: Length Within Range: 6 to 55)

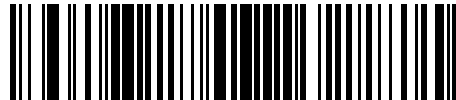

I 2 of 5 - Any Length

## Interleaved 2 of 5 (I 2 of 5) Check Digit Verification

### Parameter # 49 (SSI #31h)

This parameter enables or disables checking the integrity of all I 2 of 5 symbols to verify the data complies with either the specified Uniform Symbology Specification (USS) or the Optical Product Code Council (OPCC) check digit algorithm.

- \*Disable - disables checking the integrity of all I 2 of 5 symbols to verify the data complies.
- USS Check Digit - enables checking the integrity of USS.
- OPCC Check Digit - enables checking the integrity of OPCC.

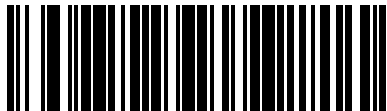

\*Disable (0)



USS Check Digit (1)

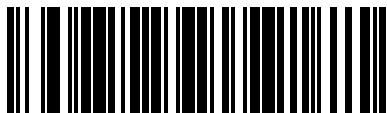

OPCC Check Digit (2)

## Transmit I 2 of 5 Check Digit

### Parameter # 44 (SSI #2Ch)

This parameter enables or disables transmission of I 2 of 5 data with or without the check digit.

- Enabled - enables transmission of check digit.

- \*Disabled - disables transmission of check digit.

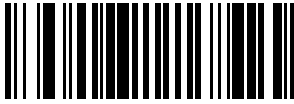

Transmit I 2 of 5 Check Digit (Enable) (1)



\*Do Not Transmit I 2 of 5 Check Digit (Disable) (0)

## Convert Interleaved 2 of 5 (I 2 of 5) to EAN-13

### Parameter # 82 (SSI #52h)

This parameter enables or disables converting 14-character I 2 of 5 codes to EAN-13, and then transmitting to the host as EAN-13.

- Enabled - enables converting 14-character I 2 of 5 codes to EAN-13.
- \*Disabled - disables converting 14-character I 2 of 5 codes to EAN-13.



**NOTE:** The I 2 of 5 code must be enabled, and the code must have a leading zero and a valid EAN-13 check digit.

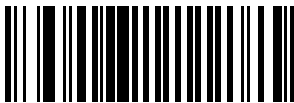

Convert I 2 of 5 to EAN-13 (Enable) (1)

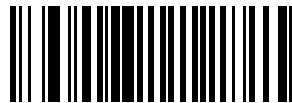

\*Do Not Convert I 2 of 5 to EAN-13 (Disable) (0)

## Interleaved 2 of 5 (I 2 of 5) Security Level

### Parameter # 1121 (SSI #F8h 04h 61h)

This parameter sets the security level for I 2 of 5.

I 2 of 5 barcodes are vulnerable to misdecodes, particularly when I 2 of 5 Lengths is set to Any Length. The scanner offers four levels of decode security for I 2 of 5 barcodes. There is an inverse relationship between security and scanner aggressiveness. Increasing the level of security can reduce scanning aggressiveness, so select only the level of security necessary.

- I 2 of 5 Security Level 0: The scanner operates in its most aggressive state, while providing sufficient security in decoding most in-spec barcodes.
- I 2 of 5 Security Level 1: A barcode must be successfully read twice, and satisfy certain safety requirements before being decoded. This default setting eliminates most misdecodes.
- I 2 of 5 Security Level 2: This option applies greater barcode security requirements if Security Level 1 fails to eliminate misdecodes.

- I 2 of 5 Security Level 3: If you selected Security Level 2, and misdecodes still occur, select this security level. The highest safety requirements are applied. A barcode must be successfully read three times before being decoded.



**NOTE:** Selecting this option is an extreme measure against mis-decoding severely out-of-spec barcodes, and significantly impairs the decoding ability of the scanner. If this level of security is required, try to improve the quality of the barcodes.

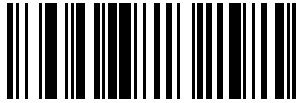

I 2 of 5 Security Level 0 (0)

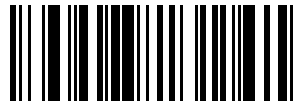

\*I 2 of 5 Security Level 1 (1)



I 2 of 5 Security Level 2 (2)



I 2 of 5 Security Level 3 (3)

## Interleaved 2 of 5 (I 2 of 5) Reduced Quiet Zone

### Parameter # 1210 (SSI #F8h 04h B9h)

This parameter enables or disables decoding I 2 of 5 with reduced quiet zones (the margins on either side of the barcode).

If you select Enable, select a [1D Quiet Zone Level](#).

- Enabled - enables I 2 of 5 with reduced Quiet Zones.
- \*Disabled - disables I 2 of 5 with reduced Quiet Zones.



Enable I 2 of 5 Reduced Quiet Zone (1)



\*Disable I 2 of 5 Reduced Quiet Zone (0)



## Discrete 2 of 5 (D 2 of 5)

### Parameter # 5 (SSI #05h)

This parameter enables or disables D 2 of 5.

- Enabled - enables D 2 of 5.
- \*Disabled - disables D 2 of 5.

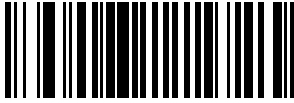

Enable Discrete 2 of 5 (1)

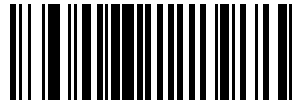

\*Disable Discrete 2 of 5 (0)

## Set Lengths for Discrete 2 of 5 (D 2 of 5)

### L1 Parameter # 20 (SSI #14h)

### L2 Parameter # 21 (SSI #15h)

This parameter sets lengths for D 2 of 5.

The length of a code refers to the number of characters (for example, human-readable characters), including check digit(s) the code contains. Set lengths for D 2 of 5 to any length, one or two discrete lengths, or lengths within a specific range. The default is Length Within Range: 1 to 55.



**NOTE:** When setting lengths, enter a leading zero for single digit numbers.

Scan one of the following barcodes to select a length option:

- One Discrete Length - Decode only D 2 of 5 symbols containing a selected length.
- Two Discrete Lengths - Decode only D 2 of 5 symbols containing either of two lengths.
- Length Within Range - Decode D 2 of 5 symbols with a specific length range.
- Any Length - Decode D 2 of 5 symbols containing any number of characters within the scanner's capability.



**NOTE:** Due to the construction of the D 2 of 5 symbology, it is possible for a scan line covering only a portion of the code to transmit as a complete scan, yielding less data than is encoded in the barcode. To prevent this, select specific lengths (D 2 of 5 - One Discrete Length, Two Discrete Lengths) for D 2 of 5 applications.

Select lengths using barcodes in [Numeric Barcodes](#). To correct an error or change the selection, scan [Cancel](#).

For example:

- To decode only D 2 of 5 symbols with 14 characters, scan D 2 of 5 - One Discrete Length, and then scan 1, 4.

- To decode only D 2 of 5 symbols containing either 2 or 14 characters, scan D 2 of 5 - Two Discrete Lengths, and then scan 0, 2, 1, 4.
- To decode D 2 of 5 symbols containing between 4 and 12 characters, scan D 2 of 5 - Length Within Range, and then scan 0, 4, 1, 2.



D 2 of 5 - One Discrete Length

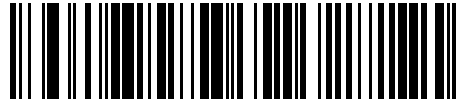

D 2 of 5 - Two Discrete Lengths



\*D 2 of 5 - Length Within Range(Default: Length Within Range: 1 to 55 )

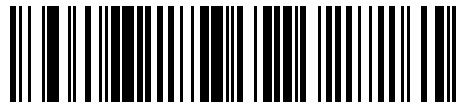

D 2 of 5 - Any Length

## Codabar (NW - 7)

### Parameter # 7 (SSI #07h)

This parameter enables or disables Codabar.

- \*Enabled - enables Codabar.
- Disabled - disables Codabar.



\*Enable Codabar (1)

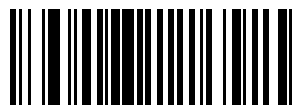

Disable Codabar (0)

## Set Lengths for Codabar

L1 Parameter # 24 (SSI #18h)

L2 Parameter # 25 (SSI #19h)

This parameter sets lengths for Codabar.

The length of a code refers to the number of characters (for example, human-readable characters), including check digit(s) the code contains. Set lengths for Codabar to any length, one or two discrete lengths, or lengths within a specific range. The default is Length Within Range: 4 to 55.



**NOTE:** When setting lengths, enter a leading zero for single-digit numbers.

- One Discrete Length - Decode only Codabar symbols containing a selected length.
- Two Discrete Lengths - Decode only Codabar symbols containing either of two lengths.
- Length Within Range - Decode Codabar symbols with a specific length range.
- Any Length - Decode Codabar symbols containing any number of characters within the scanner's capability.

Select lengths using barcodes in [Numeric Barcodes](#). To correct an error or change the selection, scan [Cancel](#).

For example:

- To decode only Codabar symbols with 14 characters, scan Codabar - One Discrete Length, and then scan 1, 4.
- To decode only Codabar symbols containing either 2 or 14 characters, scan Codabar - Two Discrete Lengths, and then scan 0, 2, 1, 4.
- To decode Codabar symbols containing between 4 and 12 characters, scan Codabar - Length Within Range, and then scan 0, 4, 1, 2.



Codabar - One Discrete Length

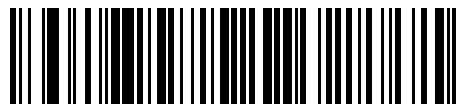

Codabar - Two Discrete Lengths



\*Codabar - Length Within Range (Default: Length Within Range: 4 to 55 )

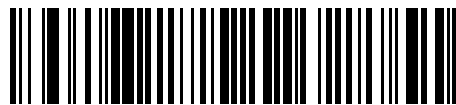

Codabar - Any Length

## CLSI Editing

Parameter # 54 (SSI #36h)

This parameter enables or disables CLSI editing.

Select Enable CLSI Editing to strip the start and stop characters and insert a space after the first, fifth, and tenth characters of a 14-character Codabar symbol if the host system requires this data format.

- Enabled - enables CLSI editing.
- \*Disabled - disables CLSI editing.



**NOTE:** Symbol length does not include start and stop characters.

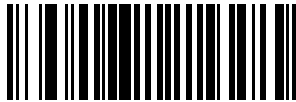

Enable CLSI Editing (1)

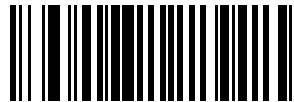

\*Disable CLSI Editing (0)

## NOTIS Editing

### Parameter # 55 (SSI #37h)

This parameter enables or disables NOTIS editing which strips the start and stop characters from a decoded Codabar symbol if the host system requires this data format.

- Enabled - enables NOTIS editing.
- \*Disabled - disables NOTIS editing.

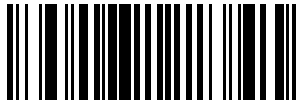

Enable NOTIS Editing (1)

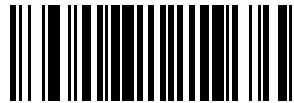

\*Disable NOTIS Editing (0)

## Codabar Security Level

### Parameter # 1776 (SSI #F8h 06h F0h)

This parameter sets the security level for Codabar 39.

The scanner offers four levels of decode security for Codabar barcodes. There is an inverse relationship between security and scanner aggressiveness. Increasing the level of security can reduce scanning aggressiveness, so select only the level of security necessary.

- Codabar Security Level 0: This setting allows the scanner to operate in its most aggressive state, while providing sufficient security in decoding most in-spec barcodes.

- Codabar Security Level 1: This default setting eliminates most misdecodes.
- Codabar Security Level 2: Select this option with greater barcode security requirements if Security Level 1 fails to eliminate misdecodes.
- Codabar Security Level 3: If you selected Security Level 2, and misdecodes still occur, select this security level to apply the highest safety requirements.



**NOTE:** Selecting this option is an extreme measure against mis-decoding severely out-of-spec barcodes, and significantly impairs the decoding ability of the scanner. If this level of security is required, try to improve the quality of the barcodes.

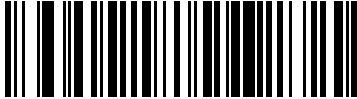

Codabar Security Level 0 (0)

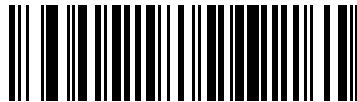

\*Codabar Security Level 1 (1)

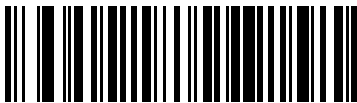

Codabar Security Level 2 (2)



Codabar Security Level 3 (3)

## Codabar Upper or Lower Case Start/Stop Characters

### Parameter # 855 (SSI #F2h 57h)

This parameter selects whether to transmit upper case or lower case Codabar start/stop characters.

- Lower Case (1) - enables lowercase start/stop characters.
- \*Upper Case (0) - enables upper case start/stop characters.



Lower Case (1)

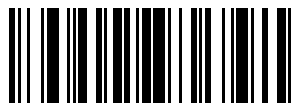

\*Upper Case (0)

## Codabar Mod 16 Check Digit Verification

### Parameter # 1784 (SSI #F8h 06h F8h)

This parameter checks the Codabar Mod 16 check digit to verify that the data complies with the specified check digit algorithm.

- Enabled - enables check digit.
- \*Disabled - disables check digit.



Enable Codabar Mod 16 Check digit (1)



\*Disable Codabar Mod 16 Check digit (0)

## Transmit Codabar Check Digit

### Parameter # 704 (SSI #F1h C0h)

This parameter selects whether or not to transmit the Codabar check digit(s).

- Enabled - enables check digit transmission.
- \*Disabled - disables check digit transmission.



Enable Codabar Check Digit Transmission (1)



\*Disable Codabar Check Digit Transmission (0)

## MSI

### Parameter # 11 (SSI #0Bh)

This parameter enables or disables MSI.

- Enabled - enables MSI.
- \*Disabled - disables MSI.



Enable MSI (1)

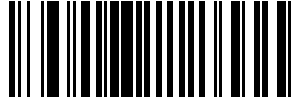

\*Disable MSI (0)

## Set Lengths for MSI

L1 Parameter # 30 (SSI #1Eh)

L2 Parameter # 31 (SSI #1Fh)

This parameter sets lengths for MSI.

The length of a code refers to the number of characters (for example, human-readable characters), including check digit(s) the code contains. Set lengths for MSI to any length, one or two discrete lengths, or lengths within a specific range. The default is Length Within Range: 1 to 54.



**NOTE:** When setting lengths, enter a leading zero for single-digit numbers.

Scan one of the following barcodes to select a length option:

- One Discrete Length - Decode only MSI symbols containing a selected length.
- Two Discrete Lengths - Decode only MSI symbols containing either of two lengths.
- Length Within Range - Decode MSI symbols with a specific length range.
- Any Length - Decode MSI symbols containing any number of characters within the scanner's capability.



**NOTE:** Due to the construction of the MSI symbology, it is possible for a scan line covering only a portion of the code to transmit as a complete scan, yielding less data than is encoded in the barcode. To prevent this, select specific lengths (MSI - One Discrete Length, Two Discrete Lengths) for MSI applications.

Select lengths using barcodes in [Numeric Barcodes](#). To correct an error or change the selection, scan [Cancel](#).

For example:

- To decode only MSI symbols with 14 characters, scan MSI - One Discrete Length, and then scan 1, 4.
- To decode only MSI symbols containing either 2 or 14 characters, scan MSI - Two Discrete Lengths, and then scan 0, 2, 1, 4.
- To decode MSI symbols containing between 4 and 12 characters, scan MSI - Length Within Range, and then scan 0, 4, 1, 2.

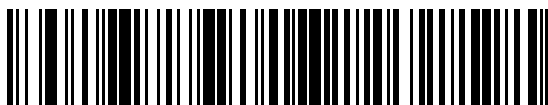

MSI - One Discrete Length

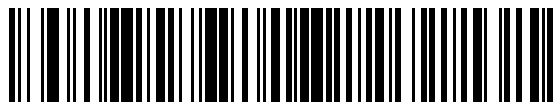

MSI - Two Discrete Lengths

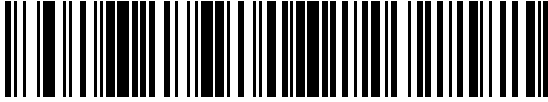

\*MSI - Length Within Range (Default: Length Within Range: 1 to 54)

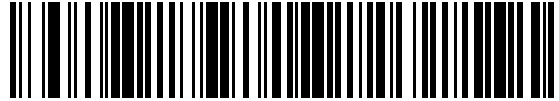

MSI - Any Length

## MSI Check Digits

### Parameter # 50 (SSI #32h)

This parameter checks the MSI check digit to verify that the data complies with the specified check digit algorithm.

With MSI symbols, one check digit is mandatory and always verified by the reader. The second check digit is optional. If the MSI codes include two check digits, select the Two MSI Check Digits option to enable verification of the second check digit.

- 0 - Does not check the MSI check digit; decodes MSI with no check digit.
- 1 - This is for MSI barcodes with one check digit. This is the default.
- 2 - This is for MSI barcodes with two check digits.

See [MSI Check Digit Algorithm](#) to select second digit algorithms.



No MSI Check Digit (0)



\*One MSI Check Digits (1)



Two MSI Check Digit (2)

## Transmit MSI Check Digit(s)

### Parameter # 46 (SSI #2Eh)

This parameter transmits MSI data with or without the check digit.

- Enabled - transmits MSI data with check digit.
- \*Disabled - does not transmit MSI data check digit.



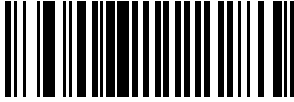

Transmit MSI Check Digit(s) (Enable) (1)

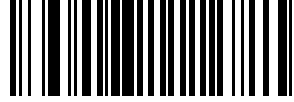

\*Do Not Transmit MSI Check Digit(s) (Disable) (0)

## MSI Check Digit Algorithm

### Parameter # 51 (SSI #33h)

This parameter selects the algorithm used to encode the check digit.

Two algorithms are available for verifying the second MSI check digit. Select one of the following options to select the algorithm used to encode the check digit.

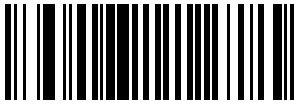

MOD 11/MOD 10 (0)

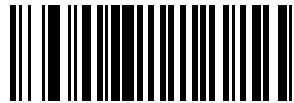

\*MOD 10/MOD 10 (1)

## Chinese 2 of 5

### Parameter # 408 (SSI #98h)

This parameter enables or disables Chinese 2 of 5.

- Enabled - enables Chinese 2 of 5.
- \*Disabled - disables Chinese 2 of 5.



Enable Chinese 2 of 5 (1)

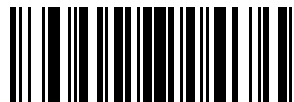

\*Disable Chinese 2 of 5 (0)

## Matrix 2 of 5

### Parameter # 618 (SSI #F1h 6Ah)

This parameter enables or disables Matrix 2 of 5.

- Enabled - enables Matrix 2 of 5.
- \*Disabled - disables Matrix 2 of 5.



Enable Matrix 2 of 5 (1)



\*Disable Matrix 2 of 5 (0)

## Set Lengths for Matrix 2 of 5

### L1 Parameter # 619 (SSI #F1h 6Bh)

### L2 Parameter # 620 (SSI #F1h 6Ch)

This parameter set lengths for Matrix 2 of 5.

The length of a code refers to the number of characters (for example, human-readable characters), including check digit(s) the code contains. Set lengths for Matrix 2 of 5 to any length, one or two discrete lengths, or lengths within a specific range. The default is Length Within Range: 4 to 55.



**NOTE:** When setting lengths, enter a leading zero for single-digit numbers.

Scan one of the following barcodes to select a length option:

- One Discrete Length - Decode only Matrix 2 of 5 symbols containing a selected length.
- Two Discrete Lengths - Decode only Matrix 2 of 5 symbols containing either of two lengths.
- Length Within Range - Decode Matrix 2 of 5 symbols with a specific length range.
- Any Length - Decode Matrix 2 of 5 symbols containing any number of characters within the scanner's capability.

Select lengths using barcodes in [Numeric Barcodes](#). To correct an error or change the selection, scan [Cancel](#).

For example:

- To decode only Matrix 2 of 5 symbols with 14 characters, scan Matrix 2 of 5 - One Discrete Length, and then scan 1, 4.
- To decode only Matrix 2 of 5 symbols containing either 2 or 14 characters, scan Matrix 2 of 5 - Two Discrete Lengths, and then scan 0, 2, 1, 4.
- To decode Matrix 2 of 5 symbols containing between 4 and 12 characters, scan Matrix 2 of 5 - Length Within Range, and then scan 0, 4, 1, 2.

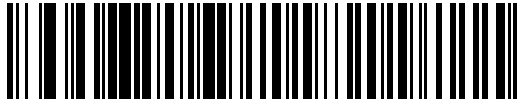

Matrix 2 of 5 - One Discrete Length



Matrix 2 of 5 - Two Discrete Lengths

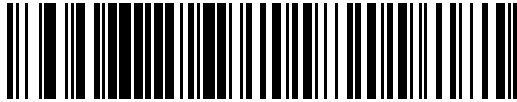

\*Matrix 2 of 5 - Length Within Range (Default:4 to 55)



Matrix 2 of 5 - Any Length

## Matrix 2 of 5 Check Digit

### Parameter # 622 (SSI #F1h 6Eh)

This parameter determines whether to include the Matrix 2 of 5 check digit with the barcode data.

The check digit is the last character of the symbol used to verify the integrity of the data.

- Enabled - enables Matrix 2 of 5 Check Digit.
- \*Disabled - disables Matrix 2 of 5 Check Digit.



Enable Matrix 2 of 5 Check Digit (1)

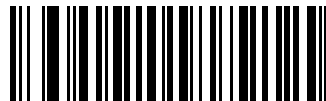

\*Disable Matrix 2 of 5 Check Digit (0)

## Transmit Matrix 2 of 5 Check Digit

### Parameter # 623 (SSI #F1h 6Fh)

This parameter transmits Matrix 2 of 5 data with or without the check digit.

- Transmit - enables Transmit Matrix 2 of 5 Check Digit.
- \*Do Not Transmit - does not Transmit Matrix 2 of 5 Check Digit.



Transmit Matrix 2 of 5 Check Digit (1)

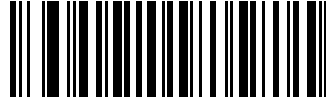

\*Do Not Transmit Matrix 2 of 5 Check Digit (0)

## Korean 3 of 5

### Parameter # 581 (SSI #F1h 45h)

This parameter enables or disables Korean 3 of 5.

- Enabled - enables Korean 3 of 5.
- \*Disabled - disables Korean 3 of 5.



**NOTE:** The length for Korean 3 of 5 is fixed at 6.



Enable Korean 3 of 5 (1)



\*Disable Korean 3 of 5 (0)

## Inverse 1D

### Parameter # 586 (SSI #F1h 4Ah)

This parameter sets the 1D inverse decoder setting.

- Regular Only - The scanner decodes regular 1D barcodes only.
- Inverse Only - The scanner decodes inverse 1D barcodes only.
- Inverse Autodetect - The scanner decodes both regular and inverse 1D barcodes.



**NOTE:** This parameter does not apply to GS1 DataBarcode types.



**NOTE:** The Inverse 1D setting may impact Composite or Inverse Composite decoding.



\*Regular Only (0)

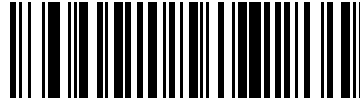

Inverse Only (1)



Inverse Autodetect (2)

## GS1 DataBar

The variants of GS1 DataBar are DataBar Omnidirectional, DataBar Limited, and DataBar Expanded. The limited and expanded versions have stacked variants. Choose to enable or disable each variant of the GS1 DataBar.

### GS1 DataBar Omnidirectional (formerly GS1 DataBar-14)

#### Parameter # 338 (SSI #F0h 52h)

This parameter enables or disables GS1 DataBar Omnidirectional.

- \*Enabled - enables GS1 DataBar Omnidirectional.
- Disabled - disables GS1 DataBar Omnidirectional.



\*Enable GS1 DataBar Omnidirectional (1)

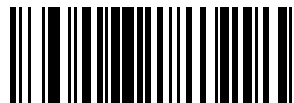

Disable GS1 DataBar Omnidirectional (0)

### GS1 DataBar Limited

#### Parameter # 339 (SSI #F0h 53h)

This parameter enables or disables GS1 DataBar Limited.

- \*Enabled - enables GS1 DataBar Limited.
- Disabled - disables GS1 DataBar Limited.

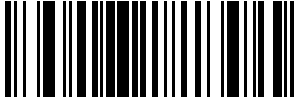

\*Enable GS1 DataBar Limited (1)

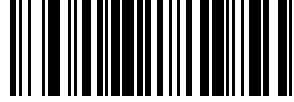

Disable GS1 DataBar Limited (0)

## GS1 DataBar Expanded

### Parameter # 340 (SSI #F0h 54h)

This parameter enables or disables GS1 DataBar Expanded.

- \*Enabled - enables GS1 DataBar Expanded.
- Disabled - disables GS1 DataBar Expanded.

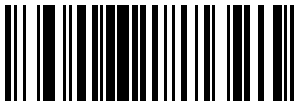

\*Enable GS1 DataBar Expanded (1)

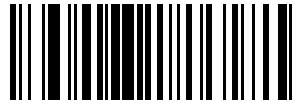

Disable GS1 DataBar Expanded (0)

## Convert GS1 DataBar to UPC/EAN/JAN

### Parameter # 397 (SSI #F0h, 8Dh)

This parameter enables or disables Convert GS1 DataBar to UPC/EAN/JAN.

- Enabled - enables Convert GS1 DataBar to UPC/EAN/JAN.
- \*Disabled - disables Convert GS1 DataBar to UPC/EAN/JAN.

This parameter only applies to GS1 DataBar Omnidirectional and GS1 DataBar Limited symbols not decoded as part of a Composite symbol. Enable Convert GS1 DataBar to UPC/EAN/JAN strips the leading '010' from DataBar Omnidirectional and DataBar Limited symbols encoding a single zero as the first digit, and then reports as EAN-13.

For barcodes beginning with between two and five zeros, this strips the leading '0100' and reports the barcode as UPC-A. The [UPC-A Preamble](#) option that transmits the system character and country code applies to converted barcodes. Note that neither the system character nor the check digit can be stripped.



Enable Convert GS1 DataBar to UPC/EAN/JAN (1)

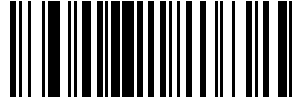

\*Disable Convert GS1 DataBar to UPC/EAN/JAN (0)

## GS1 DataBar Limited Margin Check

Parameter # 728 (SSI #F1h D8h)

This parameter sets the margin level for GS1 DataBar.

The scanner offers four levels of decode security for GS1 DataBar Limited barcodes. There is an inverse relationship between the level of margin check and scanner aggressiveness. Increasing the level of margin check can reduce scanning aggressiveness, so select only the level of margin check necessary.

- Margin Check Level 1 – No clear margin required. This complies with the original GS1 standard, yet can result in erroneous decoding of a DataBar Limited barcode when scanning some UPC symbols that start with digits 9 and 7.
- Margin Check Level 2 – Automatic risk detection. This level of margin check can result in erroneous decoding of DataBar Limited barcodes when scanning some UPC symbols. If a misdecode is detected, the scanner operates in Level 3 or Level 1.
- \*Margin Check Level 3 – Margin check level reflects the newly proposed GS1 standard that requires a five times trailing clear margin.
- Margin Check Level 4 – Margin check level extends beyond the standard required by GS1. This level of margin check requires a five times leading and trailing clear margin.

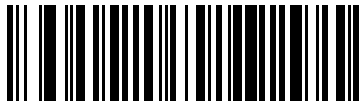

GS1 DataBar Limited Margin Check Level 1 (1)



GS1 DataBar Limited Margin Check Level 2 (2)



\*GS1 DataBar Limited Margin Check Level 3 (3)

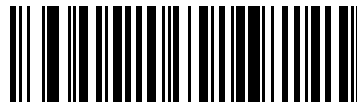

GS1 DataBar Limited Margin Check Level 4 (4)

## GS1 DataBar Security Level

Parameter # 1706 (SSI #F8h 06h AAh)

This parameter sets the security level for GS1 DataBar.

The scanner offers four levels of decode security for GS1 DataBar (GS1 DataBar Omnidirectional, GS1 DataBar Limited, GS1 DataBar Expanded) barcodes.

- Security Level 0 - The scanner operates in its most aggressive state, while providing sufficient security decoding most in-spec barcodes.
- \*Security Level 1 - This setting eliminates most misdecodes while maintaining reasonable aggressiveness.
- Security Level 2 - Select this option with greater barcode security requirements if Security Level 1 fails to eliminate misdecodes.
- Security Level 3 - If you selected Security Level 2 and misdecodes still occur, select this security level to apply the highest safety requirements.

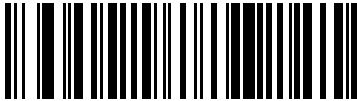

GS1 DataBar Security Level 0 (0)



\*GS1 DataBar Security Level 1 (1)



GS1 DataBar Security Level 2 (2)



GS1 DataBar Security Level 3 (3)

## Symbology-Specific Security Features

These security features are unique to the Symbology section.

### Redundancy Level

Parameter # 78 (SSI #4Eh)



This parameter selects the redundancy level appropriate for the barcode quality.

Select higher redundancy levels for decreasing levels of barcode quality. As redundancy levels increase, the scanner's aggressiveness decreases.

- \*Redundancy Level 1 - The scanner must read the following code types twice before decoding:
  - Codabar (8 characters or less)
  - MSI (4 characters or less)
  - D 2 of 5 (8 characters or less)
  - I 2 of 5 (8 characters or less)
- Redundancy Level 2 - The scanner must read all code types twice before decoding.
- Redundancy Level 3 - The scanner must read code types other than the following twice before decoding, but must read the following codes three times:
  - Codabar (8 characters or less)
  - MSI (4 characters or less)
  - D 2 of 5 (8 characters or less)
  - I 2 of 5 (8 characters or less)
- Redundancy Level 4 - The scanner must read all code types three times before decoding.

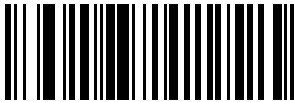

\*Redundancy Level 1 (1)



Redundancy Level 2 (2)

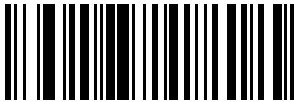

Redundancy Level 3 (3)

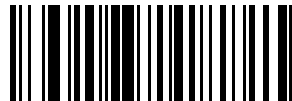

Redundancy Level 4 (4)

## Security Level

### Parameter # 77 (SSI #4Dh)

This parameter sets the security level.

The scanner offers four levels of decode security, which include the Code 128 family, UPC/EAN/JAN, and Code 93. Select increasing levels of security for decreasing levels of scanning quality. There is an inverse

relationship between security and scanner aggressiveness, so choose only that level of security necessary for the application.

- Security Level 0 - The scanner operates in its most aggressive state, while providing sufficient security decoding most in-spec barcodes.
- Security Level 1 - This default setting eliminates most mis-decodes.
- Security Level 2 - Select this option if Security Level 1 fails to eliminate mis-decodes.
- Security Level 3 - If you selected Security Level 2 and mis-decodes still occur, select this security level.



**NOTE:** Selecting this option is an extreme measure against mis-decoding severely out-of-spec barcodes, and significantly impairs the decoding ability of the scanner. If this level of security is required, try to improve the quality of the barcodes.

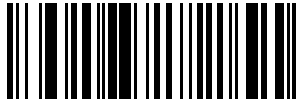

Security Level 0 (0)

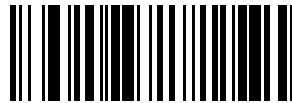

\*Security Level 1 (1)

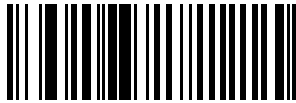

Security Level 2 (2)

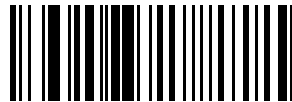

Security Level 3 (3)

## 1D Quiet Zone Level

### Parameter # 1288 (SSI #F8h 05h 08h)

This parameter sets the level of aggressiveness when setting a reduced quiet zone (the margin on either side of a barcode), and applies to symbologies enabled by a Reduced Quiet Zone parameter.

Because higher levels increase the decoding time and risk of mis-decodes, Zebra strongly recommends enabling only the symbologies which require higher quiet zone levels, and leaving Reduced Quiet Zone disabled for all other symbologies. Options are:

- 1D Quiet Zone Level 0 - The scanner performs normally in terms of quiet zone.
- \*1D Quiet Zone Level 1 - The scanner performs more aggressively in terms of quiet zone.
- 1D Quiet Zone Level 2 - The scanner only requires a quiet zone at the end of barcode for decoding.
- 1D Quiet Zone Level 3 - The scanner decodes anything in terms of quiet zone or end of barcode.



1D Quiet Zone Level 0 (0)

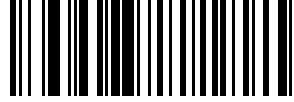

\*1D Quiet Zone Level 1 (1)

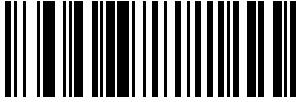

1D Quiet Zone Level 2 (2)

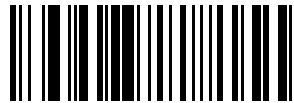

1D Quiet Zone Level 3 (3)

## Intercharacter Gap Size

### Parameter # 381 (SSI #F0h 7Dh)

This parameter enables a device to tolerate large intercharacter gap sizes.

The Code 39 and Codabar symbologies have an intercharacter gap that is typically quite small. Due to various barcode printing technologies, this gap can grow larger than the maximum size allowed, preventing the scanner from decoding the symbol. If this problem occurs, scan the Large Intercharacter Gaps parameter to tolerate these out-of-specification barcodes.

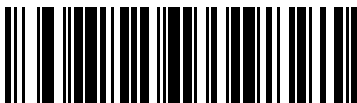

\*Normal Intercharacter Gaps (6)



Large Intercharacter Gaps (10)

## Composite

Composites link symbols or barcodes together and they are read by a scanner as one object.

### Composite CC-C

#### Parameter # 341 (SSI #F0h 55h)

This parameter enables or disables Composite barcodes of type CC-C.

- Enabled - enables CC-C.
- \*Disabled - disables CC-C.

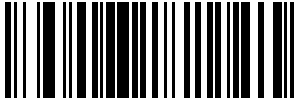

Enable CC-C (1)



\*Disable CC-C (0)

## Composite CC-A/B

### Parameter # 342 (SSI #F0h 56h)

This parameter enables or disables CC-A/B.

- Enabled - enables CC-A/B.
- \*Disabled - disables CC-A/B.

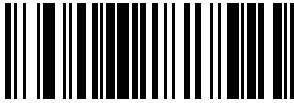

Enable CC-A/B (1)

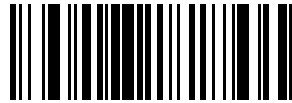

\*Disable CC-A/B (0)

## Composite TLC-39

### Parameter # 371 (SSI #F0h 73h)

This parameter enables or disables TLC-39.

- Enabled - enables TLC-39.
- \*Disabled - disables TLC-39.

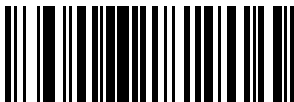

Enable TLC39 (1)

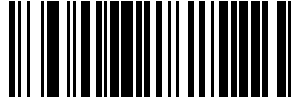

\*Disable TLC39 (0)

## Composite Inverse

### Parameter # 1113 (SSI #F8h 04h 59h)

This parameter sets Composite for either regular decode or inverse decode.

- \*Regular Only - The scanner decodes regular Composite barcodes only. Before selecting this, set [Inverse 1D](#) to Regular Only or Inverse Autodetect.
- Inverse Only - The scanner decodes inverse Composite barcodes only. This mode only supports Composite Inverse that includes DataBar combined with CCAB, and does not support other 1D/2D combinations. Before selecting this, first enable [Composite CC-A/B](#), and set [Inverse 1D](#) to Inverse Only or Inverse Autodetect.



\*Regular Only (0)

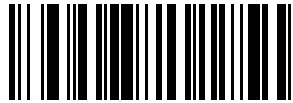

Inverse Only (1)

## UPC Composite Mode

### Parameter # 344 (SSI #F0h 58h)

This parameter links UPC symbols with a 2D symbol during transmission as if they were one symbol.

- \*UPC Never Linked - Transmit UPC barcodes regardless of whether a 2D symbol is detected.
- UPC Always Linked - Transmit UPC barcodes and the 2D portion. If 2D is not present, do not transmit the barcode.
- Autodiscriminate UPC Composites - The scanner determines if there is a 2D portion, then transmits the UPC, as well as the 2D portion if present.



\*UPC Never Linked (0)

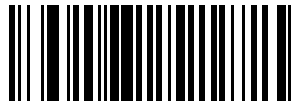

UPC Always Linked (1)

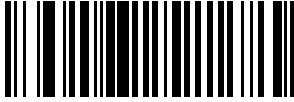

Autodiscriminate UPC Composites (2)

## Composite Beep Mode

### Parameter # 398 (SSI #F0h 8Eh)

This parameter selects the number of decode beeps that sound upon decoding a Composite.

- Single Beep - after both are decoded.
- \*Beep for each code type - as each code type is decoded.
- Double Beep - after both are decoded.

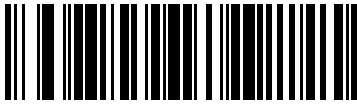

Single Beep After Both are Decoded (0)



\*Beep as Each Code Type is Decoded (1)

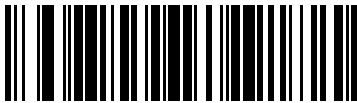

Double Beep After Both are Decoded (2)

## GS1-128 Emulation Mode for UCC/EAN Composite Codes

### Parameter # 427 (SSI #F0h ABh)

This parameter enables or disables GS1-128 Emulation Mode for UCC/EAN Composite Codes.

- Enabled - enables GS1-128 Emulation Mode for UCC/EAN Composite Codes.
- \*Disabled - disables GS1-128 Emulation Mode for UCC/EAN Composite Codes.

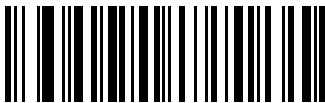

Enable GS1-128 Emulation Mode for UCC/EAN Composite Codes (1)



\*Disable GS1-128 Emulation Mode for UCC/EAN Composite Codes (0)

## 2D Symbologies

The following parameters are specific to 2D Symbologies.

### PDF417

#### Parameter # 15 (SSI 0Fh)

This parameter enables or disables PDF417.

- \*Enabled - enables PDF417.
- Disabled - disables PDF417.

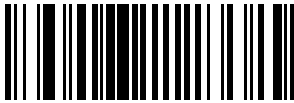

\*Enable PDF417 (1)

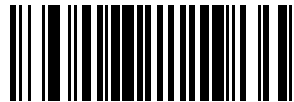

Disable PDF417 (0)

### MicroPDF417

#### Parameter # 227 (SSI #E3h)

This parameter enables or disables MicroPDF417

- Enabled - enables MicroPDF417.
- \*Disabled - disables MicroPDF417.

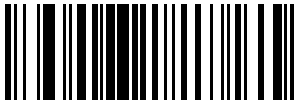

Enable MicroPDF417 (1)

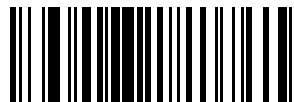

\*Disable MicroPDF417 (0)

### Code 128 Emulation

#### Parameter # 123 (SSI #7Bh)

This parameter transmits data from certain MicroPDF417 symbols as Code 128.

You must enable [AIM Code Characters](#) for this parameter to work.

Enable Code 128 Emulation to transmit these MicroPDF417 symbols with one of the following prefixes:

]C1 if the first codeword is 903-905

]C2 if the first codeword is 908 or 909

]C0 if the first codeword is 910 or 911

Disable Code 128 Emulation to transmit these MicroPDF417 symbols with one of the following prefixes:

]L3 if the first codeword is 903-905

]L4 if the first codeword is 908 or 909

]L5 if the first codeword is 910 or 911



**NOTE:** Linked MicroPDF codewords 906, 907, 912, 914, and 915 are not supported. Use GS1 Composites instead.

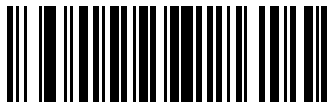

Enable Code 128 Emulation (1)

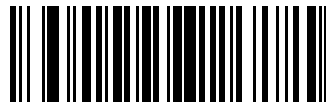

\*Disable Code 128 Emulation (0)

## Data Matrix

### Parameter # 292 (SSI #F0h 24h)

This parameter enables or disables Data Matrix.

- \*Enabled - enables Data Matrix.
- Disabled - disables Data Matrix.



\*Enable Data Matrix (1)

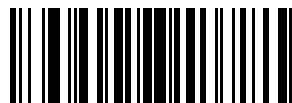

Disable Data Matrix (0)



## GS1 Data Matrix

### Parameter # 1336 (SSI #F8h 05h 38h)

This parameter enables or disables GS1 Data Matrix.

- Enabled - enables GS1 Data Matrix.
- \*Disabled - disables GS1 Data Matrix.



Enable GS1 Data Matrix (1)

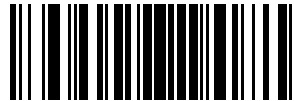

\*Disable GS1 Data Matrix (0)

## Data Matrix Inverse

### Parameter # 588 (SSI #F1h 4Ch)

This parameter selects the Data Matrix inverse decoder setting.

- Regular Only - The scanner decodes regular Data Matrix barcodes only.
- Inverse Only - The scanner decodes inverse Data Matrix barcodes only.
- \*Inverse Autodetect - The scanner decodes both regular and inverse Data Matrix barcodes.

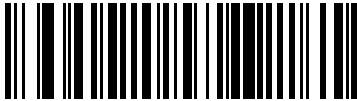

Regular Only (0)

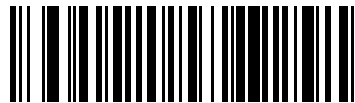

Inverse Only (1)



\*Inverse Autodetect (2)

## Maxicode

### Parameter # 294 (SSI #F0h 26h)

This parameter enables or disables Maxicode.

- Enabled - enables Maxicode.

- \*Disabled - disables Maxicode.



Enable Maxicode (1)



\*Disable Maxicode (0)

## QR Code

### Parameter # 293 (SSI #F0h 25h)

This parameter enables or disables QR Code.

- \*Enabled - enables QR Code.
- Disabled - disables QR Code.



**NOTE:** Enabling this also enables QR Mirrored and Linked QR.

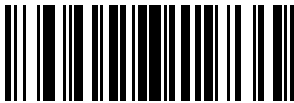

\*Enable QR Code (1)

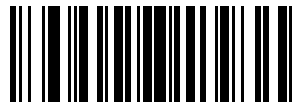

Disable QR Code (0)

## GS1 QR

### Parameter # 1343 (SSI #F8h 05h 3Fh)

This parameter enables or disables GS1 QR.

- Enabled - enables GS1 QR
- Disabled - disables GS1 QR.



Enable GS1 QR (1)

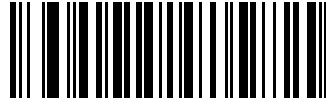

\*Disable GS1 QR (0)

## MicroQR

### Parameter # 573 (SSI #F1h 3Dh)

This parameter enables or disables MicroQR.

- \*Enabled - enables MicroQR.
- Disabled - disables MicroQ.

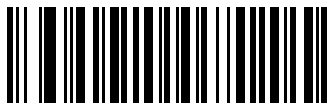

\*Enable MicroQR (1)



Disable MicroQR (0)

## Linked QR Mode

### Parameter # 1847 (SSI #737h)

This parameter selects a linked QR mode.

- \*Linked QR Only - The scanner does not decode individual QR symbols from a set of linked QR codes.
- Individual QR With Headers - The scanner decodes individual QR symbols from a set of linked QR codes and retains the header information and data.
- Individual QR No Headers - The scanner decodes individual QR symbols from a set of linked QR codes and transmits the data without header information.

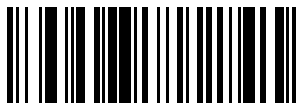

\*Linked QR Only (0)

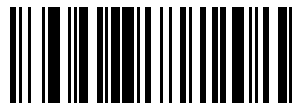

Individual QR With Headers (1)



Individual QR No Headers (2)

## Aztec

### Parameter # 574 (SSI #F1h 3Eh)

This parameter enables or disables Aztec.

- \*Enabled - enables Aztec.
- Disabled - disables Aztec.



**NOTE:** Enabling this also enables Linked Aztec.

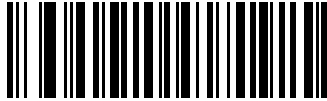

\*Enable Aztec (1)



Disable Aztec (0)

## Aztec Inverse

### Parameter # 589 (SSI #F1h 4Dh)

This parameter selects the Aztec inverse decoder setting.

- Regular Only - The scanner decodes regular Aztec barcodes only.
- Inverse Only - The scanner decodes inverse Aztec barcodes only.
- \*Inverse Autodetect - The scanner decodes both regular and inverse Aztec barcodes.



Regular Only (0)

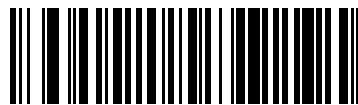

Inverse Only (1)



\*Inverse Autodetect (2)

## Han Xin

### Parameter # 1167 (SSI #F8h 04h 8Fh)

This parameter enables or disables Han Xin.

- Enabled - enables Han Xin.
- \*Disabled - disables Han Xin.



Enable Han Xin (1)

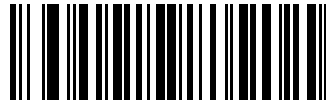

\*Disable Han Xin (0)

## Han Xin Inverse

### Parameter # 1168 (SSI #F8h 04h 90h)

This parameter selects a Han Xin inverse decoder setting.

- \*Regular Only - The scanner decodes Han Xin barcodes with normal reflectance only.
- Inverse Only - The scanner decodes Han Xin barcodes with inverse reflectance only.
- Inverse Autodetect - The scanner decodes both regular and inverse Han Xin barcodes.

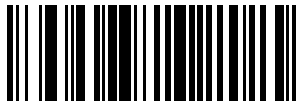

\*Regular Only (0)

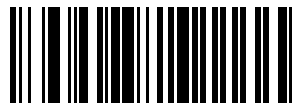

Inverse Only (1)

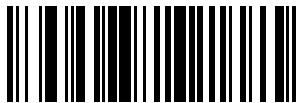

Inverse Autodetect (2)

## Grid Matrix

### Parameter # 1718 (SSI #F8 06h B6h)

This parameter enables or disables Grid Matrix.

- Enabled - enables Grid Matrix.
- \*Disabled - disables Grid Matrix.



Enable Grid Matrix (1)



\*Disable Grid Matrix (0)

## Grid Matrix Inverse

### Parameter # 1719 (SSI #F8h 06h B7h)

This parameter selects a Grid Matrix inverse decoder setting.

- \*Regular Only - the imager decodes Grid Matrix barcodes with normal reflectance only.
- Inverse Only - the imager decodes Grid Matrix barcodes with inverse reflectance only.
- Inverse Autodetect - the imager decodes both regular and inverse Grid Matrix barcodes.

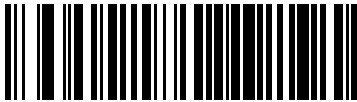

\*Regular (0)



Inverse Only (1)

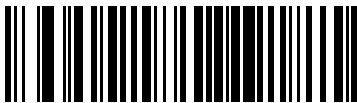

Inverse Autodetect (2)

## Grid Matrix Mirrored

### Parameter # 1736 (SSI #F8h 06h C8h)

This parameter selects a mirror image Grid Matrix setting.

- \*Non-Mirrored Only - the imager decodes non-mirrored Grid Matrix barcodes only.
- Mirrored Only - the imager decodes mirrored Grid Matrix barcodes only.
- Autodetect - the imager decodes both mirrored and non-mirrored Grid Matrix barcodes.



\*Non-Mirrored Only (0)



Mirrored Only (1)



Mirrored Autodetect (2)

## DotCode

### Parameter # 1906 (SSI #F8 07 72h)

You can enable or disable DotCode.

- Enabled - enables DotCode.
- \*Disabled - disables DotCode.

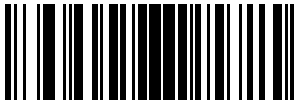

\*Disable DotCode (0)

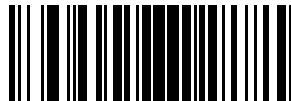

Enable Dotcode (1)

## DotCode Inverse

### Parameter # 1907 (SSI #F8 07 73h)

This parameter selects the DotCode Inverse decoder setting.

- Regular Only - the device decodes DotCode Inverse codes with normal reflectance only.
- Inverse Only - the device decodes DotCode Inverse codes with inverse reflectance only.
- Inverse Autodetect - the device decodes DotCode Inverse codes with both normal and inverse reflectance.



Regular (0)



Inverse Only (1)



\*Autodetect (2)

## DotCode Mirrored

### Parameter # 1908 (SSI #F8 07 74h)

This parameter sets a DotCode Mirror decoder setting.

- Never - decodes non-mirrored DotCode codes only.
- Always - decodes mirrored DotCode codes only.
- \*Autodetect - decodes both mirrored and non-mirrored DotCode codes.

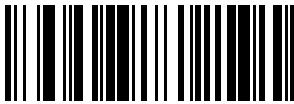

Never (0)



Always (1)

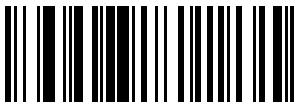

\*Autodetect

## DotCode Prioritize

### Parameter # 1937 (SSI #F8 07 91h)

This parameter enables or disables giving priority to DotCode decoding versus other symbologies.

- \*Disabled - disables DotCode as a priority.
- Enabled - enables DotCode as a priority.

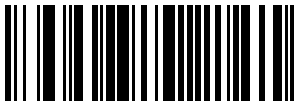

\*Disable DotCode Prioritize (0)

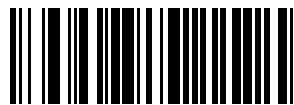

Enable DotCode Prioritize (1)



## DotCode Erasure Limit

### Parameter # 2063 (SSI # F8 08 0F)

This parameter sets the maximum number of erasures in DotCode codewords before passing the codewords for error correction.

The value range is from 4 to 20. The default value is 10. A bigger value means that DotCode barcodes are easier to decode, but the chance of getting a decode error is higher.

To set a DotCode Erasure Limit value, scan the following barcode, and then scan two barcodes from [Numeric Barcodes](#) that correspond to the desired value. Enter a leading zero for single digit numbers. For example, to set an erasure value of 4, scan this barcode, and then scan the 0 and 4 barcodes. To correct an error or change the selection, scan Cancel.



DotCode Erasure Limit

## Postal Codes

These parameters are regarding postal codes from around the globe.

### US Postnet

#### Parameter # 89 (SSI #59h)

This parameter enables or disables US Postnet.

- Enabled - enables US Postnet.
- \*Disabled - disables US Postnet.

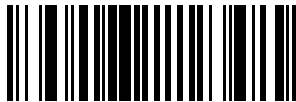

Enable US Postnet (1)

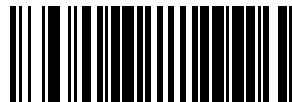

\*Disable US Postnet (0)

### US Planet

#### Parameter # 90 (SSI #5Ah)

This parameter enables or disables US Planet.

- Enabled - enables US Planet.
- \*Disabled - disables US Planet.

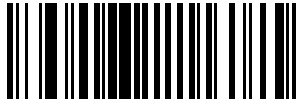

Enable US Planet (1)

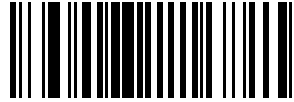

\*Disable US Planet (0)

## Transmit US Postal Check Digit

### Parameter # 95 (SSI #5Fh)

This parameter selects whether to transmit US Postal data, which includes both US Postnet and US Planet, with or without the check digit.

- \*Transmit - transmit US Postal with Check Digit.
- Do Not Transmit - do not transmit US Postal with Check Digit.



\*Transmit US Postal Check Digit (1)

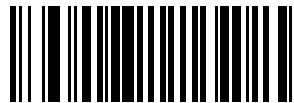

Do Not Transmit US Postal Check Digit (0)

## UK Postal

### Parameter # 91 (SSI # 5Bh)

This parameter enables or disables UK Postal.

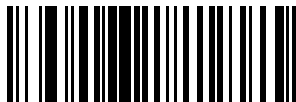

Enable UK Postal (1)

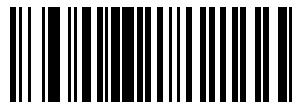

\*Disable UK Postal (0)

## Transmit UK Postal Check Digit

### Parameter # 96 (SSI # 60h)

This parameter enables or disables Transmit UK Postal Check Digit.

Scan one of the following barcodes to select whether to transmit UK Postal data with or without the check digit.

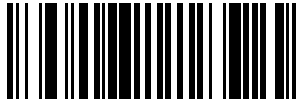

\*Transmit UK Postal Check Digit (1)

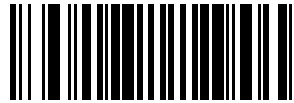

Do Not Transmit UK Postal Check Digit (0)

## Japan Postal

**Parameter # 290 (SSI # F0h, 22h)**

This parameter enables or disables Japan Postal.

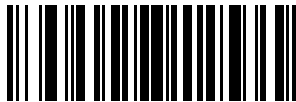

Enable Japan Postal (1)

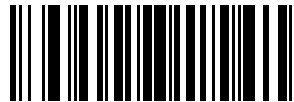

\*Disable Japan Postal (0)

## Australia Post

**Parameter # 291 (SSI # F0h, 23h)**

This parameter enables or disables Australia Post.



Enable Australia Post (1)

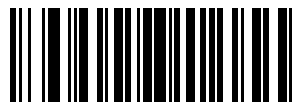

\*Disable Australia Post (0)

## Australia Post Format

**Parameter # 718 (SSI # F1h, CEh)**

This parameter enables or disables Australia Post Format.

- Autodiscriminate (or Smart mode) - Decode the Customer Information Field using the N and C Encoding Tables.



**NOTE:** This option increases the risk of misdecodes because the encoded data format does not specify the Encoding Table used for encoding.

- Raw Format - Output raw bar patterns as a series of numbers 0 through 3.
- Alphanumeric Encoding - Decode the Customer Information Field using the C Encoding Table.
- Numeric Encoding - Decode the Customer Information Field using the N Encoding Table.

For more information on Australia Post Encoding Tables, refer to the Australia Post Customer Barcoding Technical Specifications available at [auspost.com.au](http://auspost.com.au).



\*Autodiscriminate (0)



Raw Format (1)



Alphanumeric Encoding (2)

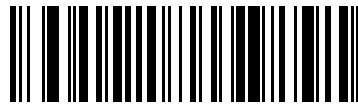

Numeric Encoding (3)

## Netherlands KIX Code

### Parameter # 326 (SSI # F0h, 46h)

This parameter enables or disables Netherlands KIX Code.

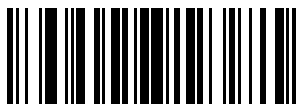

Enable Netherlands KIX Code (1)

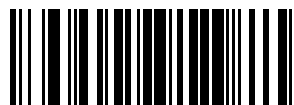

\*Disable Netherlands KIX Code (0)

## USPS 4CB/One Code/Intelligent Mail

### Parameter # 592 (SSI # F1h 50h)

This parameter enables or disables USPS 4CB/One Code/Intelligent Mail.

Scan one of the following barcodes to enable or disable USPS 4CB/One Code/Intelligent Mail.

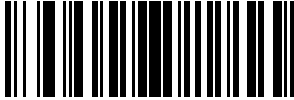

Enable USPS 4CB/One Code/Intelligent Mail (1)

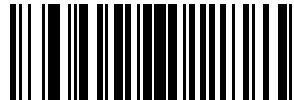

\*Disable USPS 4CB/One Code/Intelligent Mail (0)

## UPU FICS Postal

### Parameter # 611 (SSI # F1h 63h)

This parameter enables or disables Code 39.

Scan one of the following barcodes to enable or disable UPU FICS Postal.



Enable UPU FICS Postal (1)

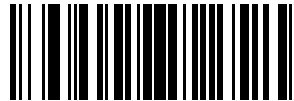

\*Disable UPU FICS Postal (0)

## Mailmark

### Parameter # 1337 (SSI # F8h 05h 39h)

This parameter enables or disables Mailmark.

Scan one of the following barcodes to enable or disable Mailmark.

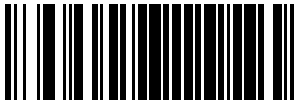

\*Disable Mailmark (0)

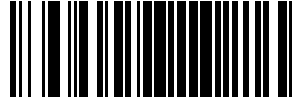

Enable Mailmark (1)

## Macro PDF Features

Macro PDF is a special feature for combining multiple PDF symbols into one file. The scanner can decode symbols encoded with this feature, and can store more than 64 Kb of decoded data from up to 50 MacroPDF symbols.

When printing, keep each Macro PDF sequence separate, as each sequence has unique identifiers. Do not mix barcodes from several Macro PDF sequences, even if they encode the same data. When scanning a Macro PDF sequence, scan the entire sequence without interruption. When scanning a mixed sequence, two long low beeps (low/low) indicate an inconsistent file ID or inconsistent symbology error.

## Flush Macro PDF Buffer

This parameter flushes the buffer of all decoded Macro PDF data stored to that point, transmits it to the host device, and aborts from Macro PDF mode.

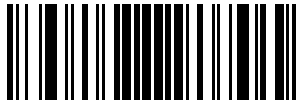

Flush Macro PDF Buffer

# Intelligent Document Capture (Hand-Held Mode Only)

Intelligent Document Capture (IDC) is Zebra advanced image processing firmware for select imager based scanners.

This section describes IDC functionality, provides parameter barcodes to control IDC features, and includes a quick start procedure.

## The Intelligent Document Capture (IDC) Process

The IDC process includes the following steps.

1. Verifies a barcode is appropriate to use as an IDC anchor or link. See [Barcode Acceptance Test](#).
2. Determines the rectangular region to capture as an image. See [Capture Region Determination](#).
3. Processes the captured image. See [Image Post Processing](#).
4. Transmits the data. See [Data Transmission](#).

### Barcode Acceptance Test

Upon decoding a barcode, the scanner checks that the barcode fits the description of a barcode that anchors or links to an IDC form.

To be accepted as an IDC barcode:

- The symbology must be enabled for decode, and also enabled via [IDC Symbology](#). The IDC firmware allows enabling between zero and eight symbologies simultaneously: Code 128, Code 39, Interleaved 2 of 5, Discrete 2 of 5, Codabar, PDF417, Data Matrix, and EAN-128.
- The decoded data must satisfy the values set in the [IDC Minimum Text Length](#) and [IDC Maximum Text Length](#) parameters. To disable either of these checks, set the value to zero.

If the barcode does not satisfy both requirements, it is sent as a normal (non-IDC) decode.

An IDC barcode is required when [IDC Operating Mode](#) is set to **Anchored** or **Linked**.

**Free-Form** operating mode does not require a barcode, but transmits decoded data if one is found and satisfies the requirements. If no barcode is decoded, the document capture process starts but may require specifying a non-zero value for the [IDC Delay Time](#). The scanner must wait for at least this amount of time after trigger pull before capturing a document, unless a barcode is decoded before the time expires.

If [Picklist Mode](#) is enabled, the barcode must be directly under the aiming pattern and within the scanner's decode range, and the region to capture must be completely within the scanner's field-of-view.

## Capture Region Determination

After accepting an IDC barcode, the firmware establishes the region to capture as an image.

The method used depends on the setting of the [IDC Operating Mode](#).

The IDC firmware emits a single low beep after successfully capturing a region. The scanner is then no longer capturing images and can be moved without disturbing the IDC output. Be sure to hold the trigger button until the decode beep, otherwise the IDC process may be aborted.

### IDC Operating Mode (Anchored)

A coordinate system is built based on the barcode in its rectified (de-skewed) form. The origin is the center of the barcode, and the x-axis is set toward the right, from the barcode's point of view. The unit module width of the barcode is the unit for x. Similarly, the y-axis is set toward the up direction. The unit for the y-axis is specified via the parameter [IDC Aspect](#). This is the aspect ratio of a thin bar or space - the barcode's height is divided by this value to get this unit. Set IDC Aspect to zero to automatically calculate the aspect ratio. The barcode can be of different sizes for the same form, as long as the center of the barcode is the same when the barcode's length changes.

From this coordinate system, the IDC area is determined using four parameters: offsets in x and y ([IDC X Coordinate](#), [IDC Y Coordinate](#)) to the region's top-left corner, and width and height [IDC Width](#), [IDC Height](#)).

If the capture area is relatively large as compared to the barcode area, the calculation to obtain the capture area is prone to significant errors. A recommended solution is to enclose the form with a single black-lined rectangular border (a box), which is not in contact with any other line on the outside of the form (although it can be connected to lines on the inside of the form). When the [IDC Find Box Outline](#) is set, the firmware searches for the box, and does not decode if any edges are broken (such as by a protruding thumb).

The [IDC Zoom Limit](#) parameter controls the quality of the captured form. The IDC firmware rejects capturing a form unless the width is at least the IDC Zoom Limit percentage of the IDC Width parameter. For example, if IDC Zoom Limit is set to 100 and IDC Width Limit is set to 150, the form must be at least 300 pixels wide before it is captured (each unit module is scaled to two pixels).

The [IDC Maximum Rotation](#) parameter controls the maximum rotation any edge of the form can have in relation to the scanner's horizontal or vertical axis.

### IDC Operating Mode (Free-Form or Linked)

The document capture region is a rectangular piece of paper, or a portion of it enclosed by a rectangular border.

In either case, all four sides of the capture region must be completely within the scanner's field-of-view, and there must be sufficient contrast at the border of the capture region. For example, if a piece of white paper contains the document to capture, it must be put in front of a dark background.

By default, the scanner captures the largest rectangular region within the field-of-view. To specify a particular border type, use the [IDC Border Type](#) parameter.

The region must contain at least 10% of the field-of-view in two dimensions.

If an IDC barcode is decoded, IDC uses its location to start the search for the capture region. Otherwise, it searches the capture region from the center of the field-of-view. IDC also uses the orientation of a decoded IDC barcode to orient the output image.



## Image Post Processing

After determining the document capture region, the firmware de-skews and re-samples the region as follows. Enabling [IDC Captured Image Brighten](#) calls normalization, which makes the brightness of the image uniform, and enhances contrast as a large percent of background pixels is made completely white (a smaller percent of pixels is made completely black if the firmware determines there is no danger of enhancing the contrast of a very bland area). Enabling [IDC Captured Image Sharpen](#) enhances the sharpness of the image.

IDC re-samples the image about one output pixel per input pixel for **Free-Form** or **Linked** modes and two pixels-per-module in **Anchored** mode.

IDC compresses and transmits the image in one of the standard image formats selected by the [IDC File Format Selector](#), [IDC Bits Per Pixel](#), and [IDC JPEG Quality](#) parameters.



**NOTE:** It might take several seconds for post processing to complete, depending on the size of the captured region, the options enabled, and the scanner model.

## Data Transmission

After processing the captured image, IDC assembles the image with the decoded barcode data (if applicable) into an ISO/IEC 15434 style packet and transmits it to the host.

The scanner issues the standard decode beep and the trigger can be released. Be sure to set the [USB Device Type](#) to **Symbol Native API (SNAPI) with Imaging Interface**.

## PC Application and Programming Support

This application displays barcode data and/or captured images from Intelligent Document Capture enabled scanners and allows setting and reading IDC parameters.

For a sample application running on the Microsoft Windows operating system, contact your Zebra representative. Complete source code and documentation are also provided for developing custom applications. The application includes documentation for the ISO/IEC 15434 format as used by the IDC firmware and C# code to process it.

## Image Document Capture Parameter Defaults

The following table lists defaults for IDC parameters. Change these values in one of two ways:

- Scan the appropriate barcodes in this section. The new value replaces the standard default value in memory. To recall default parameter values, see [Default Parameters](#).
- Configure the scanner using the 123Scan configuration program. See [123Scan and Software Tools](#).

Alternatively, use the sample application to set parameters using the parameter name. The application provides prompts and error checking to assist in setting the parameters correctly and easily. You must use an application to set a parameter to a negative value, as the [IDC X Coordinate](#) can require.

**Table 32** IDC Parameter Defaults

Parameter	Parameter Name	Parameter Number <sup>a</sup>	SSI Number <sup>b</sup>	Default
Intelligent Document Capture (IDC) Parameters				

**Table 32** IDC Parameter Defaults (Continued)

Parameter	Parameter Name	Parameter Number <sup>a</sup>	SSI Number <sup>b</sup>	Default
IDC Operating Mode	DocCap_MODE	594	F1h 52h	Off
IDC Symbology	DocCap_SYMBOLGY	655	F1h 8Fh	001
IDC X Coordinate	DocCap_X	596	F4h F1h 54h	-151
IDC Y Coordinate	DocCap_Y	597	F4h F1h 55h	-050
IDC Width	DocCap_WIDTH	598	F1h 56h	0300
IDC Height	DocCap_HEIGHT	599	F1h 57h	0050
IDC Aspect	DocCap_ASPECT	595	F1h 53h	000
IDC File Format Selector	DocCap_FMT	601	F1h 59h	JPEG
IDC Bits Per Pixel	DocCap_BPP	602	F1h 5Ah	8 BPP
IDC JPEG Quality	DocCap_JPEG_Qual	603	F1h 5Bh	065
IDC Find Box Outline	Sig_FINDBOX	727	F1h D7h	Disable
IDC Minimum Text Length	DocCap_MIN_TEXT	656	F1h 90h	00
IDC Maximum Text Length	DocCap_MAX_TEXT	657	F1h 91h	00
IDC Captured Image Brighten	Sig_BRIGHTEN	654	F1h 8Eh	Enable
IDC Captured Image Sharpen	Sig_SHARPEN	658	F1h 92h	Enable
IDC Border Type	DocCap_BORDER	829	F2h 3Dh	None
IDC Delay Time	DocCap_DELAY	830	F2h 3Eh	000
IDC Zoom Limit	Sig_MIN_PERCENT	651	F1h 8Bh	000
IDC Maximum Rotation	Sig_MAX_ROT	652	F1h 8Ch	00

<sup>a</sup> Parameter number decimal values are used for programming via RSM commands.

<sup>b</sup> SSI number hex values are used for programming via SSI commands.

## IDC Operating Mode

### Parameter Name DocCap\_MODE # 594 (SSI # F1h 52h)

Select the operating mode of the Intelligent Document Capture firmware.

- Off - Disables the IDC feature.
- Anchored - Requires a barcode decode. The image capture region is based on this barcode.
- Free-Form - A printed border or page edge defines the image capture region. A barcode is optional.
- Linked - A printed border or page edge defines the image capture region. A barcode is required.



\*Off (0)



Anchored (1)

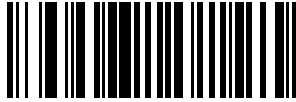

Free-Form (2)



Linked (3)

## IDC Symbology

### Parameter Name DocCap\_SYMBOLOGY # 655 (SSI # F1h 8Fh)

Select the option to use when Document Capture mode is not set to **Off**.



**NOTE:** To enable more than one symbology at a time, simply add the values together. For example, to enable PDF417, Data Matrix, and Code 39 write a value of 98 (32 + 64 + 2).

**Table 33** IDC Symbologies

Symbology	Value (Decimal)
Code 128	1
Code 39	2
I 2 of 5	4
D 2 of 5	8
Codabar	16
PD 417	32
Data Matrix	64
EAN 128	128
Aztec	256

Scan IDC Symbology, and then scan three barcodes from [Numeric Barcodes](#) in the range of 000 to 255 decimal.



IDC Symbology

## IDC X Coordinate

### Parameter Name DocCap\_X # 596 (SSI # F4h F1h 54h)

Specify the horizontal offset to the top left corner of the region to capture relative to the center of the barcode. Negative values move toward the left.



**NOTE:** This parameter only applies when [IDC Operating Mode](#) is set to Anchored.

You must use an application to set a negative value.

Choose IDC X Coordinate and then scan four barcodes from [Numeric Barcodes](#) in the range of +/- 1279.



IDC X Coordinate

## IDC Y Coordinate

### Parameter Name DocCap\_Y # 597 (SSI # F4h F1h 55h)

Specify the vertical offset to the top left corner of the region to capture relative to the center of the barcode. Negative values move toward the top.



**NOTE:** This parameter only applies when [IDC Operating Mode](#) is set to **Anchored**.

You must use an application to set a negative value.

Choose IDC Y Coordinate and then scan four barcodes from [Numeric Barcodes](#) in the range of +/- 1023.

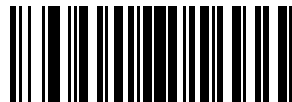

IDC Y Coordinate

## IDC Width

### Parameter Name DocCap\_WIDTH # 598 (SSI # F1h 56h)

Specify the width of the region to capture.



**NOTE:** This parameter only applies when [IDC Operating Mode](#) is set to Anchored.

Choose IDC Width and then scan four barcodes from [Numeric Barcodes](#) in the range of 0000 to 1279.



IDC Width

## IDC Height

### Parameter Name DocCap\_HEIGHT # 599 (SSI # F1h 57h)

Specify the height of the region to capture.



**NOTE:** This parameter only applies when [IDC Operating Mode](#) is set to Anchored.

Choose IDC X Coordinate and then scan four barcodes from [Numeric Barcodes](#) in the range of 0000 to 1279.

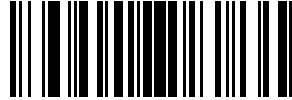

IDC Height

## IDC Aspect

### Parameter Name DocCap\_ASPECT # 595 (SSI # F1h 53h)

Specify the barcode's aspect ratio of a thin bar or space.

The barcode's height is divided by this value to obtain the unit in the y-axis. Set this parameter to zero to calculate the aspect value automatically.



**NOTE:** This parameter only applies when [IDC Operating Mode](#) is set to **Anchored**.

Choose IDC X Coordinate and then scan three barcodes from [Numeric Barcodes](#) in the range of 000 to 255.

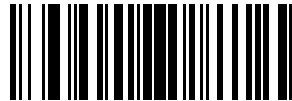

IDC Aspect

## IDC File Format Selector

### Parameter Name DocCap\_FMT # 601 (SSI # F1h 59h)

Select a document capture file format appropriate for your system (BMP, TIFF, or JPEG). The scanner stores captured areas in the selected format.



\*JPEG (1)

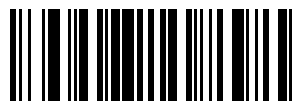

BMP (3)

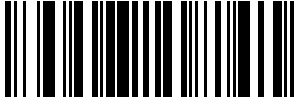

TIFF (4)

## IDC Bits Per Pixel

### Parameter Name DocCap\_BPP # 602 (SSI # F1h 5Ah)

Select the number of significant bits per pixel (BPP) to use when capturing an image.

Select 1 BPP for a black and white image, 4 BPP to assign 1 of 16 levels of grey to each pixel, or 8 BPP to assign 1 of 256 levels of grey to each pixel.



**NOTE:** The scanner ignores these settings for JPEG file formats, which only support 8 BPP.

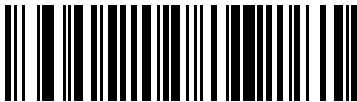

1 BPP (0)

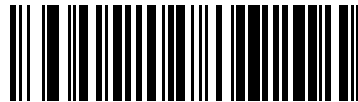

4 BPP (1)

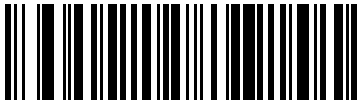

\*8 BPP (2)

## IDC JPEG Quality

### Parameter Name DocCap\_JPEG\_Qual # 603 (SSI # F1h 5Bh)

Set the amount of JPEG compression to perform on the captured image. Higher numbers produce a better quality image but larger files.

Scan IDC JPEG Quality, and then scan three barcodes from [Numeric Barcodes](#) in the range of 005 to 100 decimal.



IDC JPEG Quality

## IDC Find Box Outline

### Parameter Name Sig\_FINDBOX # 727 (SSI # F1h D7h)

Select `Enable Find Box Outline` to search for a rectangular border during document capture.



**NOTE:** This parameter only applies when `IDC Operating Mode` is set to `Anchored`.



Enable Find Box Outline (1)



\*Disable Find Box Outline (0)

## IDC Minimum Text Length

**Parameter Name** `DocCap_MIN_TEXT # 656 (SSI # F1h 90h)`

Specify the minimum number of characters encoded in a barcode for the IDC firmware to use it as an anchored or linked barcode.



**NOTE:** Set this to zero to disable all checking and use all barcodes.

Choose `IDC Minimum Text Length` and then scan two barcodes from [Numeric Barcodes](#) in the range of 00 to 55 decimal.

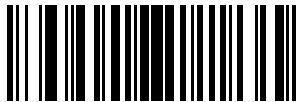

IDC Minimum Text Length

## IDC Maximum Text Length

**Parameter Name** `DocCap_MAX_TEXT # 657 (SSI # F1h 91h)`

Specify the maximum number of characters encoded in a barcode for the IDC firmware to use as an anchored or linked barcode.



**NOTE:** Set this to zero to disable all checking and use all barcodes.

Choose `IDC Maximum Text Length` and then scan two barcodes from [Numeric Barcodes](#) in the range of 00 to 55 decimal.



IDC Maximum Text Length

## IDC Captured Image Brighten

### Parameter Name Sig\_BRIGHTEN # 654 (SSI # F1h 8Eh)

Enable `Captured Image Brighten` to make image brightness uniform and enhance contrast such that a large percent of the background pixels is made completely white (a smaller percent of pixels is made completely black if the program determines there is no danger of enhancing the contrast of a very bland area).



**NOTE:** This parameter is also used for Signature Capture.

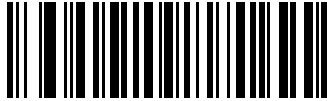

\*Enable Captured Image Brighten (1)



Disable Captured Image Brighten (0)

## IDC Captured Image Sharpen

### Parameter Name Sig\_SHARPEN # 658 (SSI # F1h 92h)

Enable this parameter to enhance the sharpness of the image.



**NOTE:** This parameter is also used for Signature Capture.

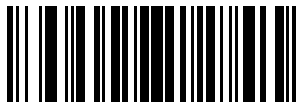

\*Enable Captured Image Sharpen (1)



Disable Captured Image Sharpen (0)

## IDC Border Type

### Parameter Name DocCap\_BORDER # 829 (SSI # F2h 3Dh)

Select the style of border used to determine the outline of the capture region.



**NOTE:** This parameter only applies when [IDC Operating Mode](#) is set to **Free-Form** or **Linked** .

- None - Capture the largest rectangular region within the field-of-view.
- Black - The border must be black (such as a printed rectangular border).



- White - The border must be white (e.g., paper edge on a dark background).
- Advanced Edge Detection (AED) - Capture a region defined by edges of any color and potentially broken.



\*None (0)



Black (1)



White (2)



Advanced Edge Detection (AED) (3)

### IDC Delay Time

#### Parameter Name **DocCap\_DELAY # 830 (SSI # F2h 3Eh)**

Set the delay for capturing a document after a trigger pull. Decoding a barcode aborts this delay.



**NOTE:** This parameter only applies when [IDC Operating Mode](#) is set to `Free-Form`.

Choose IDC Delay Time and then scan three barcodes from [Numeric Barcodes](#) in the range of 000 to 200 decimal in units of 10 msec.



IDC Delay Time

### IDC Zoom Limit

#### Parameter Name **Sig\_MIN\_PERCENT # 651 (SSI # F1h 8Bh)**

Set the minimal zoom percentage value of a form for it to be considered for capture. This controls the quality of the captured form.

The IDC firmware rejects capturing a form unless the width is at least the IDC Zoom Limit percentage of the [IDC Width](#) parameter. For example, if you set this parameter to 100 and IDC Width to 150, the form must be at least 300 pixels wide before it is captured (each unit module is scaled to two pixels).



**NOTE:** This parameter only applies when [IDC Operating Mode](#) is set to Anchored.

Choose IDC Zoom Limit and then scan three barcodes from [Numeric Barcodes](#) in the range of 000 to 100 percent. Set this to zero to disable all checking.

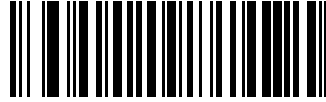

IDC Zoom Limit

## IDC Maximum Rotation

**Parameter Name Sig\_MAX\_ROT # 652 (SSI # F1h 8Ch)**

Set the maximum rotation any edge of the form can have in relation to the scanner's horizontal or vertical axis for it to be considered for capture.



**NOTE:** This parameter only applies when [IDC Operating Mode](#) is set to Anchored.

Choose IDC Maximum Rotation and then scan two barcodes from [Numeric Barcodes](#) in the range of 00 to 45 decimal. Set this to zero to disable all checking.

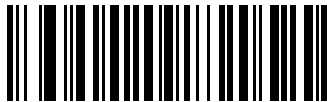

IDC Maximum Rotation

## Quick Start

This section familiarizes you with some of the Intelligent Document Capture features.

[IDC Demonstrations](#) includes instructions to demonstrate the Anchored, Free-Form, and Linked modes using a sample form to provide an understanding of how to use IDC. These examples do not illustrate all capabilities of the advanced IDC firmware. Build upon these using different parameter settings and forms.

## Sample IDC Setup

To set up IDC:

1. Connect a scanner equipped with IDC to the host computer's USB port.
2. To set the scanner to the default settings and proper USB host type, scan `Set Defaults` followed by the `Symbol Native API (SNAPI) with Imaging Interface` barcode. Allow time for the scanner to reset and the USB connection to remunerate after each scan before continuing.

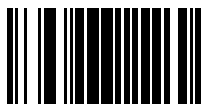

Set Defaults



Symbol Native API (SNAPI) with Imaging Interface

3. Start the sample application and select the scanner in the **SNAPI Scanners** drop-down menu.
4. Set parameters as specified in [IDC Demonstrations](#) using the sample application or by scanning parameter barcodes in this guide. The barcode in the sample form is Code 128, which is enabled by default for decoding and as a Document Capture symbology. You can change these settings for your IDC application.
5. Perform each demo. When scanning, aim the scanner at the barcode in the center of the rectangle. Pull the scanner back so the rectangle is fully contained in the aiming pattern. When you pull the trigger, the scanner emits a low tone to indicate that the IDC firmware identified and captured an image, then a decode beep to indicate that the data transmitted. There may be several seconds between the two beeps, depending on the size of the captured image and options selected (de-skew, brighten, etc). You can move the scanner after the first beep, but continue to hold the trigger or the scanner may end the session before sending the data.

## IDC Demonstrations

This section provides demonstrations of the different IDC modes.

### Anchored Mode Demo

Anchored mode captures an image of fixed size and location relative to a barcode on the page. Parameters control the height, width, and location.

The IDC firmware requires that a barcode is present in order to capture an image. It decodes the barcode and uses it to adjust the image to the upright orientation.

- Set [IDC Operating Mode](#) to **Anchored**.
- Set parameters to these values:
  - Set [IDC Height](#) to **100**.
  - Set [IDC Width](#) to **90**.
  - Set [IDC X Coordinate](#) to **-175**.
  - Set [IDC Y Coordinate](#) to **-50**.
- Pull the trigger. The scanner decodes the barcode and captures an image of the text scroll.
- Rotate the form clockwise so the word **Capture** is along the bottom edge, and pull the trigger. The scanner decodes the barcode and captures the same image, including orientation. (This example also works with the form rotated counter-clockwise or upside down).
- Modify the values for height, width, x, and y. Pull the trigger. The captured area changes in size and location.
- Cover the barcode with a small piece of paper (or your finger) and pull the trigger. The scanner does not decode the barcode or capture an image.

### Free-Form Mode Demo

Free-Form mode captures an image where a rectangular border on the page determines the size and position. It adjusts the image to the upright orientation if a barcode is found and decoded in the image.

- Set [IDC Operating Mode](#) to **Free-Form**.
- Pull the trigger. The scanner decodes the barcode and captures an image of the entire rectangle, including the contents.
- Modify the values for height, width, x, and y. Pull the trigger. Note that the captured image is not affected.
- Rotate the form clockwise so the word **Capture** is along the bottom edge, and pull the trigger. The scanner decodes the barcode and captures the same image, including orientation. (This example also works with the form rotated counterclockwise or upside down).
- Cover the barcode with a small piece of paper and pull the trigger. The scanner does not decode the barcode and does not re-orient the captured image to the normal position, i.e., with the logo in the upper-left corner.

### Linked Mode Demo

Linked mode captures an image where a rectangular border on the page determines the size and position. The IDC firmware requires that a barcode is present in order to capture an image. It decodes the barcode and uses it to adjust the image to the upright orientation.

- Set [IDC Operating Mode](#) to **Linked**.
- Use the examples from the [Free-Form Mode Demo](#), noting that the last item (covering the barcode) does not decode the barcode or capture an image.

### Other Suggestions

Hold the scanner at an angle (up/down or side to side) to the page instead of perpendicular to it.

The IDC firmware de-skews and adjusts the brightness (enabled by default) to produce a quality image when the scanner is held at less than ideal conditions.

## Quick Start Form

Use this form to practice the Quick Start demonstrations.

**Figure 13** Quick Start Form

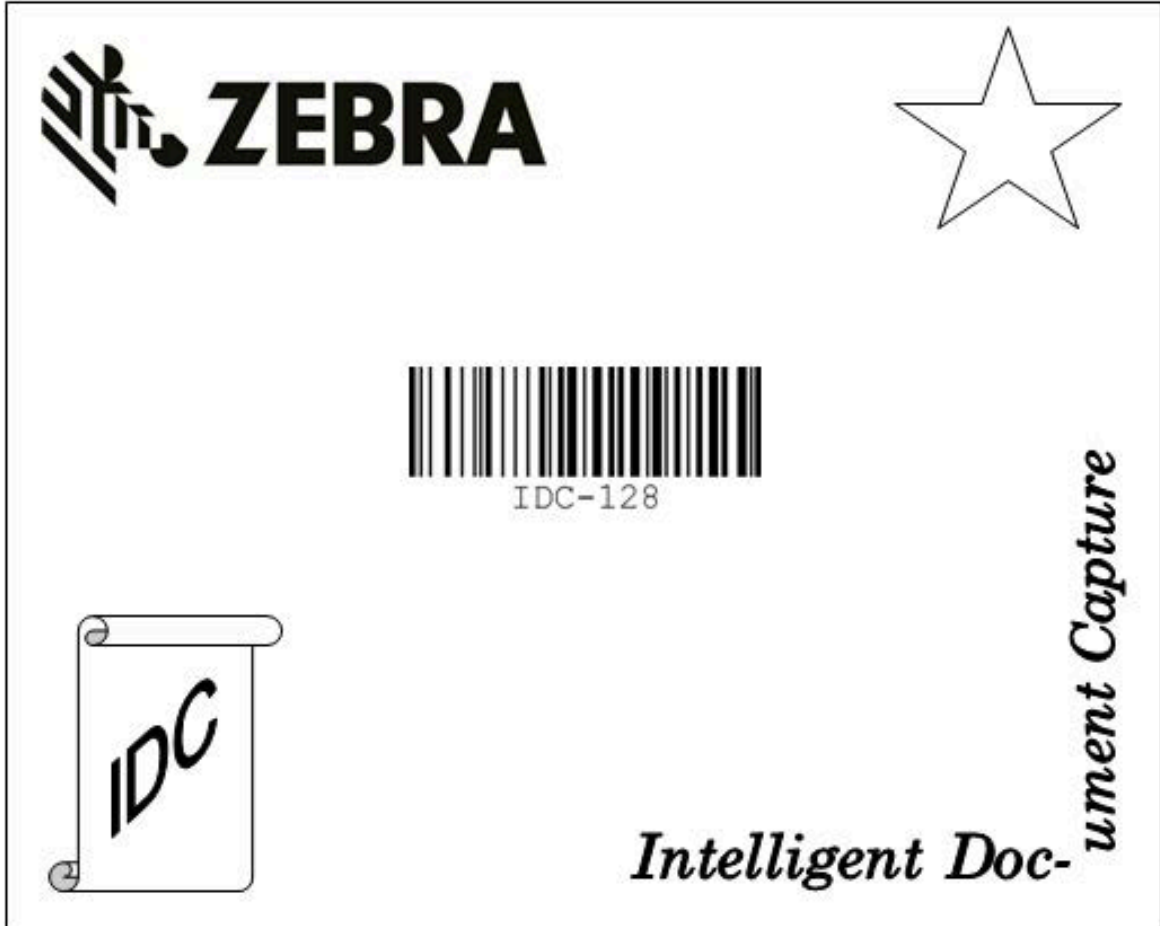

# OCR Programming

This section describes how to set up the scanner for OCR programming. The scanner can read 6 to 60-point OCR typeface. It supports font types OCR-A, OCR-B, MICR-E13B, and US Currency Serial Number.

OCR is not as secure as a barcode. To decrease OCR misdecodes and speed OCR reading, set an accurate OCR template and character subset, and use a check digit.

All OCR fonts are disabled by default. You can enable OCR-A and OCR-B at the same time but not other combined font types.

## OCR Parameter Defaults

OCR Programming Defaults lists the defaults for OCR parameters. Change these values in one of two ways:

- Scan the appropriate barcodes in this chapter. The new value replaces the standard default value in memory. To recall default parameter values, see [Default Parameters](#).
- Configure the scanner using the 123Scan configuration program. See [123Scan and Software Tools](#).



**NOTE:** See [Standard Parameter Defaults](#) on page 348 for all user preferences, host, symbology, and miscellaneous default parameters.

**Table 34** OCR Programming Defaults

Parameter	Parameter Number	SSI Number	Default
OCR-A	680	F1h A8h	Disable
OCR-A Variant	684	F1h ACh	Full ASCII
OCR-B	681	F1h A9h	Disable
OCR-B Variant	685	F1h ADh	Full ASCII
MICR E13B	682	F1h AAh	Disable
US Currency	683	F1h ABh	Disable
OCR Orientation	687	F1h AFh	0°
OCR Lines	691	F1h B3h	1
OCR Minimum Characters	689	F1h B1h	3
OCR Maximum Characters	690	F1h B2h	100
OCR Subset	686	F1h AEh	Selected font variant

**Table 34** OCR Programming Defaults (Continued)

Parameter	Parameter Number	SSI Number	Default
OCR Quiet Zone	695	F1h B7h	50
OCR Bright Illumination	701	F1h BDh	Disable
OCR Template	547	F1h 23h	99999999
OCR Check Digit Modulus	688	F1h B0h	1
OCR Check Digit Multiplier	700	F1h BCh	1212121212
OCR Check Digit Validation	694	F1h B6h	None
Inverse OCR	856	F2h 58h	Regular
OCR Redundancy	1770	F8h 06h EAh	Level 1

## OCR Programming Parameters

The OCR programming parameters enable scanners to read font types for OCR-A, OCR-B, MICR-E13B, and US Currency Serial Numbers.

### OCR-A

**Parameter # 680 (SSI # F1h A8h)**

This parameter enables scanners to read OCR-A fonts.

- Enabled - OCR-A can be read by the scanner.
- Disabled - OCR-A fonts will not be read by the scanner.



**NOTE:** OCR is not as secure as a barcode. To decrease OCR misdecodes and speed OCR reading, set an accurate OCR template and character subset, and use a check digit. See [OCR Subset](#) and [OCR Template](#).

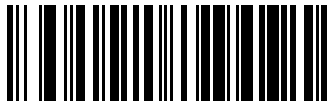

Enable OCR-A (1)



\*Disable OCR-A (0)

### OCR-A Variant

**Parameter # 684 (SSI # F1 ACh)**

This parameter enables scanners to read OCR-A font variants.

The font variant sets a processing algorithm and default character subset for the given font. Select the most appropriate font variant to optimize performance and accuracy.

OCR-A supports the following variants:

- OCR-A Full ASCII

```
!"#$%()*+,-./0123456789<>ABCDEFGHIJKLMNOPQRSTUVWXYZ\^
```

- OCR-A Reserved 1

```
$*+-. /0123456789ABCDEFGHIJKLMNOPQRSTUVWXYZ
```

- OCR-A Reserved 2

```
$*+-. /0123456789<>ABCDEFGHIJKLMNOPQRSTUVWXYZ
```

- OCR-A Banking

```
-0123456789<>
```

Special banking characters output as the following representative characters:

- ℥ outputs as f
- ℥ outputs as c
- ℥ outputs as h



**NOTE:** Enable OCR-A before setting this parameter. If disabling OCR-A, set the variant to OCR-A Full ASCII.



\*OCR-A Full ASCII (0)



OCR-A Reserved 1 (1)



OCR-A Reserved 2 (2)



OCR-A Banking (3)



## OCR-B

### Parameter # 681 (SSI # F1h A9h)

This parameter enables scanners to read OCR-B fonts.

- Enabled - OCR-B can be read by the scanner.
- Disabled - OCR-B fonts will not be read by the scanner..



**NOTE:** OCR is not as secure as a barcode. To decrease OCR misdecodes and speed OCR reading, set an accurate OCR template and character subset, and use a check digit. See [OCR Subset](#) and [OCR Template](#).

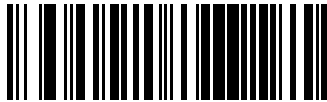

Enable OCR-B (1)

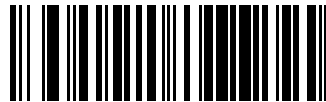

\*Disable OCR-B (0)

## OCR-B Variant

### Parameter # 685 (SSI # F1h ADh)

This parameter enables scanners to read OCR-A font variants.

OCR-A supports the following variants:

- OCR-B Full ASCII

```
!#$%()*+,-./0123456789<>ABCDEFGHIJKLMNOPQRSTUVWXYZ^ | Ñ
```

- OCR-B Banking

```
#+-0123456789<>JNP |
```

- OCR-B Limited

```
+, - . / 0123456789<>ACENPSTVX
```

- OCR-B ISBN 10-Digit Book Numbers

```
-0123456789>BCEINPSXz
```

- OCR-B ISBN 10 or 13-Digit Book Numbers

-0123456789>BCEINPSXz

- OCR-B Travel Document Version 1 (TD1) 3-Line ID Cards

-0123456789<ABCDEFGHIJKLMNQPQRSTUVWXYZ

- OCR-B Travel Document Version 2 (TD2) 2-Line ID Cards

-0123456789<ABCDEFGHIJKLMNQPQRSTUVWXYZ

- OCR-B Travel Document 2 or 3-Line ID Cards Auto-Detect

!#\$%()\*+,-./0123456789<>ABCDEFGHIJKLMNQPQRSTUVWXYZ^|Ñ

- OCR-B Passport

-0123456789<ABCDEFGHIJKLMNQPQRSTUVWXYZÑ

- OCR-B Visa Type A

-0123456789<ABCDEFGHIJKLMNQPQRSTUVWXYZ

- OCR-B Visa Type B

-0123456789<ABCDEFGHIJKLMNQPQRSTUVWXYZÑ

- OCR-B ICAO Travel Documents

This allows reading either TD1, TD2, Passport, Visa Type A, or Visa Type B without switching between these options. It automatically recognizes the travel document read.

Selecting one of the ISBN Book Numbers automatically applies the appropriate ISBN checksum, so setting this is not required.

Selecting the following OCR-B variants automatically sets the appropriate [OCR Lines](#). These five variants invoke extensive special algorithms and checking for that particular document type:

Variant	OCR Lines Setting
Passport	2
TD1 ID Cards	3
TD2 ID Cards	2
Visa Type A	2
Visa Type B	2

If you set one of these variants with both OCR-A and OCR-B enabled, only the specified travel document is read without reading OCR-A. Returning OCR-B variant to its default (Full ASCII) allows reading OCR-A.

For the best performance in passport reading, fix the target passport and the scanner in place (6.5 - 7.5”).



**NOTE:** Enable OCR-B before setting this parameter. If disabling OCR-B, set the variant to OCR-B Full ASCII.

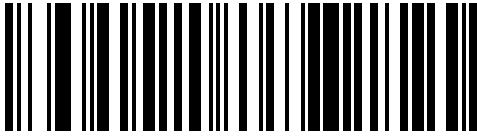

\*OCR-B Full ASCII (0)

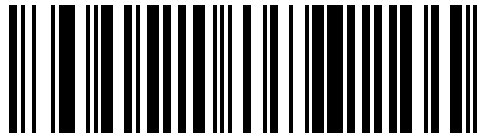

OCR-B Banking (1)

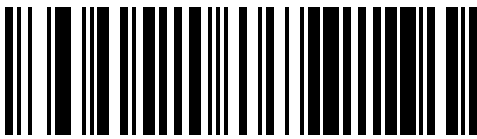

OCR-B Limited (2)

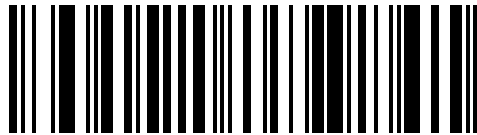

OCR-B ISBN 10-Digit Book Numbers (6)

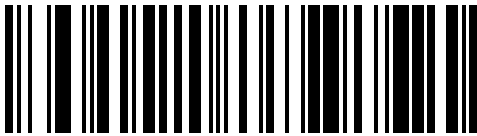

OCR-B ISBN 10 or 13-Digit Book Numbers (7)

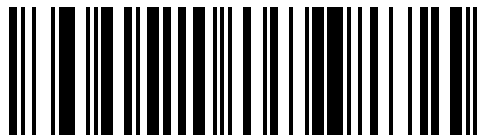

OCR-B Travel Document Version 1 (TD1) 3 Line ID Cards (3)

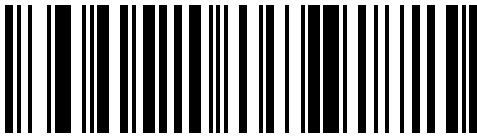

OCR-B Travel Document Version 2 (TD2) 2-Line ID Cards (8)

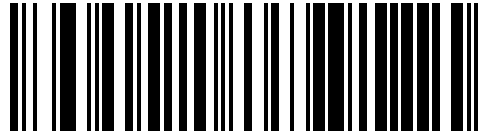

Travel Document 2 or 3-Line ID Cards Auto-Detect (20)

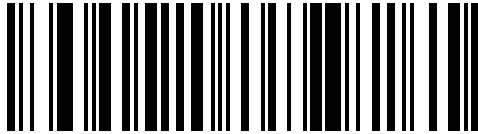

OCR-B Passport (4)

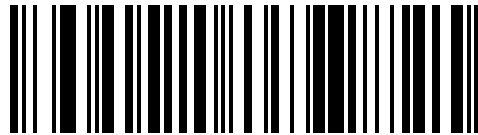

OCR-B Visa Type A (9)

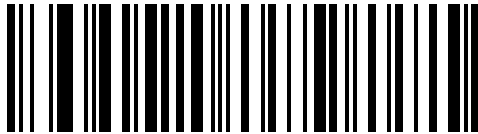

OCR-B Visa Type B (10)

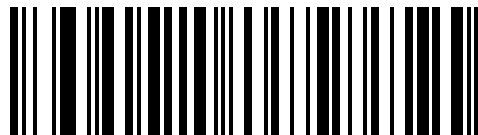

OCR-B ICAO Travel Documents (11)

## MICR E13B

### Parameter # 682 (SSI # F1h AAh)

This parameter enables scanners to read MICR E13B fonts.

MICR E 13B uses the following characters:

1 2 3 4 5 6 7 8 9 0 . ' | " ' "

TOAD characters (Transit, On Us, Amount, and Dash) output as the following representative characters:

1 outputs as **t**

' outputs as **a**

" outputs as **o**

" outputs as **d**

- Enabled - MICR E13B fonts can be read by the scanner.
- Disabled -MICR E13B fonts will not be read by the scanner..



**NOTE:** OCR is not as secure as a barcode. To decrease OCR misdecodes and speed OCR reading, set an accurate OCR template and character subset, and use a check digit. See [OCR Subset](#) and [OCR Template](#).



Enable MICR E13B (1)

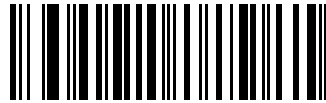

\*Disable MICR E13B (0)

## US Currency Serial Number

### Parameter # 683 (SSI # F1h ABh)

This parameter enables scanners to read US Currency Serial Numbers.

- Enabled - US Currency Serial Numbers can be read by the scanner.
- Disabled - US Currency Serial Numbers will not be read by the scanner..



**NOTE:** OCR is not as secure as a barcode. To decrease OCR misdecodes and speed OCR reading, set an accurate OCR template and character subset, and use a check digit. See [OCR Subset](#) and [OCR Template](#).



Enable US Currency (1)



\*Disable US Currency (0)

## OCR Orientation

### Parameter # 687 (SSI # F1h AFh)

This parameter specifies the orientation of the OCR to read to the imaging engine.

- OCR Orientation 0°
- OCR Orientation 270° clockwise (or 90° counterclockwise)
- OCR Orientation 180° (upside down)
- OCR Orientation 90° clockwise
- OCR Orientation Omnidirectional

Setting an incorrect orientation can cause misdecodes.



\*OCR Orientation 0° (0)



OCR Orientation 270° Clockwise (1)

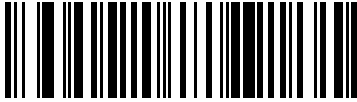

OCR Orientation 180° Clockwise (2)

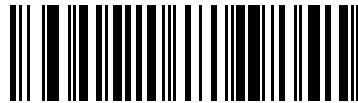

OCR Orientation 90° Clockwise (3)



OCR Orientation Omnidirectional (4)

## OCR Lines

### Parameter # 691 (SSI # F1h B3h)

This parameter selects the number of OCR lines to decode.

Selecting Visas, TD1, or TD2 ID cards automatically sets the appropriate **OCR Lines**. Also see [OCR-B Variant](#).

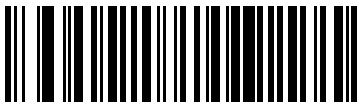

\*OCR 1 Line (1)



OCR 2 Lines (2)



OCR 3 Lines (3)

## OCR Minimum Characters

### Parameter # 689 (SSI # F1h B1h)

This parameter selects the minimum number of OCR characters (not including spaces) per line to decode.

Scan OCR Minimum Characters, then scan a three-digit number between 003 and 100 using the barcodes in [Numeric Barcodes](#) representing the number of OCR characters to decode. Strings of OCR characters less than the minimum are ignored.

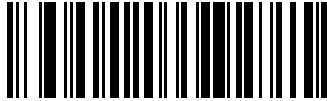

OCR Minimum Characters

## OCR Maximum Characters

### Parameter # 690 (SSI # F1h B2h)

This parameter selects the maximum number of OCR characters (including spaces) per line to decode.

Scan OCR Maximum Characters, then scan a three-digit number between 003 and 100 using the barcodes in [Numeric Barcodes](#) representing the number of OCR characters to decode. Strings of OCR characters greater than the maximum are ignored.

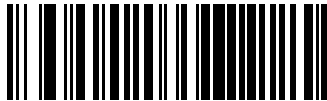

OCR Maximum Characters

## OCR Subset

### Parameter # 686 (SSI # F1h AEh)

This parameter creates an OCR subset to define a custom group of characters in place of a preset font variant.

For example, if scanning only numbers and the letters A, B, and C, create a subset of just these characters to speed decoding. This applies a designated OCR Subset across all enabled OCR fonts.

To cancel an OCR subset, for OCR-A or OCR-B, scan OCR-A variant Full ASCII, or OCR-B variant Full ASCII.

For MICR E13B or US Currency Serial Number, create a subset which includes all allowed characters in that character set, or scan an option from the [Default Parameters](#) and re-program the scanner.

### Setting or Modifying the OCR Font Subset

To set or modify the OCR Font Subset, follow this procedure.

1. Enable the appropriate OCR font(s).

2. Scan the **OCR Subset** barcode.



OCR Subset

3. Scan numbers and letters from [Alphanumeric Barcodes](#) to form the OCR Subset.
4. Scan [OCR Subset](#).

## OCR Quiet Zone

### Parameter # 695 (SSI # F1h B7h)

This parameter sets the OCR quiet zone.

The scanner stops scanning a field when it detects a sufficiently wide blank space. The width of this space is defined by the End of Field option. Used with parsers that tolerate slanted characters, the End of Field count is approximately a count of 8 for a character width. For example, if set to 15, then two character widths are an end of line indicator for the parser. Larger end of field numbers require bigger quiet zones at each end of text line.

Scan quiet zone, then scan a two-digit number using the numeric keypad in [Alphanumeric Barcodes](#). The range of the quiet zone is 20 - 99.

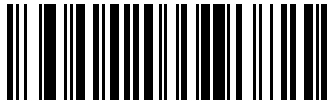

OCR Quiet Zone

## OCR Bright Illumination

### Parameter # 701 (SSI # F1h BDh)

This parameter improves image contrast for OCR scanning.

- Enabled - OCR Bright Illumination activates for the scanner.
- Disabled - OCR Bright Illumination is off for the scanner.



**NOTE:** Zebra recommends enabling this when the OCR string is longer than 20 characters, and for applications with busy backgrounds such as check or VISA reading.

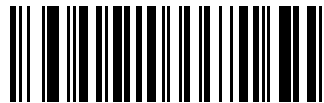

Enable OCR Bright Illumination (1)



\*Disable OCR Bright Illumination (0)



## OCR Template

### Parameter # 547 (SSI # F1h 23h)

This parameter creates a template for precisely matching scanned OCR characters to a desired input format.

Carefully constructing an OCR template eliminates scanning errors.

To set or modify the OCR decode template, scan [OCR Template](#), and then scan barcodes on the following pages that correspond to numbers and letters to form the template expression. Finally, scan **End of Message**.

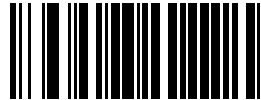

OCR Template

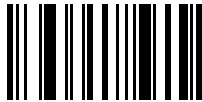

End of Message

### Required Digit (9)

Only a numeric character is allowed in this position.

Template	Valid data	Valid data	Invalid data
99999	12987	30517	123AB

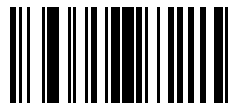

9

### Required Alpha (A)

Only an alpha character is allowed in this position.

Template	Valid data	Valid data	Invalid data
AAAAA	ABCDE	UVWXY	12FGH



A

**Optional Alphanumeric (1)**

An alphanumeric character is accepted in this position if present. Optional characters are not allowed as the first character(s) in a field of like characters.

Template	Valid data	Valid data	Invalid data
99991	1234A	12345	1234<

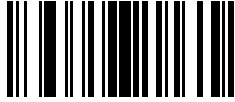

1

**Optional Alpha (2)**

An alpha character is accepted in this position if present. Optional characters are not allowed as the first character(s) in a field of like characters.

Template	Valid data	Valid data	Invalid data
AAAA2	ABCDE	WXYZ	ABCD6



2

**Alpha or Digit (3)**

An alphanumeric character is required in this position to validate the incoming data.

Template	Valid data	Valid data	Invalid data
33333	12ABC	WXYZ34	12AB<



3

**Any Including Space & Reject (4)**

Any character is accepted in this position, including space and reject. An underscore (\_) represents rejects in the output. This is a good selection for troubleshooting.

Template	Valid data	Valid data
99499	12\$34	34 98



4

**Any except Space & Reject (5)**

Any character is accepted in this position, except a space or reject.

Template	Valid data	Valid data	Invalid data
55999	A.123	*Z456	A BCD

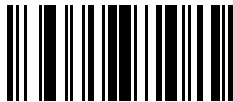

5

**Optional Digit (7)**

A numeric character is accepted if present. Optional characters are not allowed as the first character(s) in a field of like characters.

Template	Valid data	Valid data	Invalid data
99977	12345	789	789AB

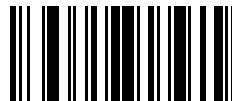

7

**Digit or Fill (8)**

Any numeric or fill character is accepted in this position.

Template	Valid data	Valid data	Valid data
88899	12345	>>789	<<789



8

**Alpha or Fill (F)**

Any alpha or fill character is accepted in this position.

Template	Valid data	Valid data	Valid data
----------	------------	------------	------------

AAFF

ABCXY

LMN>>

ABC<5



F

## Optional Space ( )

A space is accepted if present. Optional characters are not allowed as the first character(s) in a field of like characters.

Template

Valid data

Valid data

Invalid data

99 99

12 34

1234

67891

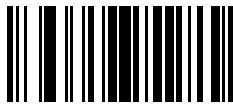

Space

## Optional Small Special (.)

A special character is accepted if present. Optional characters are not allowed as the first character(s) in a field of like characters. Small special characters are - , and .

Template

Valid data

Valid data

Invalid data

AA.99

MN.35

XY98

XYZ12



.

## Other Template Operators

These template operators assist in capturing, delimiting, and formatting scanned OCR data.

### Literal String (" and +)

Use either of these delimiting characters surrounding characters from the alphanumeric keyboard in [Alphanumeric Barcodes](#) to define a literal string within a template that must be present in scanned OCR data. There are two characters used to delimit required literal strings; if one of the delimiter characters is present in the desired literal string, use the other delimiter.

Template

Valid data

Invalid data

"35+BC"

35+BC

AB+22



“



+

## New Line (E)

To create a template of multiple lines, add **E** between the template of each single line.

Template	Valid data	Valid data	Invalid data
999EAAAA	321	987	XYZW
	BCAD	ZXYW	12



E

## String Extract (C)

This operator, combined with others, defines a string of characters to extract from the scanned data. The string extract is structured as follows:

CbPe

Where:

- C is the string extract operator
- b is the string begin delimiter
- P is the category (one or more numeric or alpha characters) describing the string representation
- e is the string end delimiter

Values for b and e can be any scannable character. They are included in the output stream.

Template	Incoming data	Output
C>A>	XQ3>ABCDE>	>ABCDE>
	->ATHRUZ>123	>ATHRUZ>
	1ABCXYZ	No Output

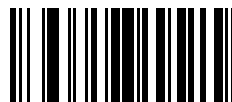

C

**Ignore to End of Field (D)**

This operator causes all characters after a template to be ignored. Use this as the last character in a template expression. Examples for the template 999D:

Template	Incoming data	Output
999D	123-PED	123
	357298	357
	193	193

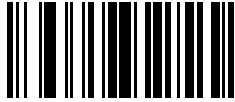

D

**Skip Until (P1)**

This operator skips over characters until a specific character type or a literal string is detected. It can be used in two ways:

```
P1ct
```

Where:

- P1 is the Skip Until operator
- c is the type of character that triggers the start of output
- t is one or more template characters

```
P1"s"t
```

Where:

- P1 is the Skip Until operator
- "s" is one or more literal string characters (for example, "+") that trigger the start of output
- t is one or more template characters

The trigger character or literal string is included in output from a Skip Until operator, and the first character in the template should accommodate this trigger.

Template	Incoming data	Output
P1"PN"AA9999	123PN9876	PN9876
	PN1234	PN1234
	X-PN3592	PN3592



P



1

**Skip Until Not (P0)**

This operator skips over characters until a specific character type or a literal string is not matched in the output stream. It can be used in two ways:

P0ct

Where:

- P0 is the Skip Until Not operator
- c is the type of character that triggers the start of output
- t is one or more template characters

P0"s"t

Where:

- P0 is the Skip Until Not operator
- "s" is one or more literal string characters (for example, "+") that trigger the start of output
- t is one or more template characters

The trigger character or literal string is not included in output from a Skip Until Not operator.

Template	Incoming data	Output
POA9999	BPN3456	3456
	PN1234	1234
	5341	No output
P0"PN"9999	PN3456	3456
	5341	No output
	PNPN7654	7654



P



0

## Repeat Previous (R)

This operator allows a template character to repeat one or more times, allowing the capture of variable-length scanned data. The following examples capture two required alpha characters followed by one or more required digits:

Template	Incoming data	Output
AA9R	AB3	AB3
	PN12345	PN12345
	32RM52700	No output

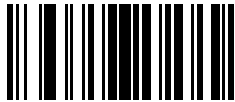

R

## Scroll Until Match (S)

This operator steps through scanned data one character at a time until the data matches the template.

Template	Incoming data	Output
S99999	AB3	No Output
	PN12345	12345
	32RM52700	52700

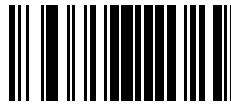

S

## Multiple Templates

This feature sets up multiple templates for OCR decoding.

To create multiple templates, see [OCR Template](#), and for each template in the multiple template string, using a capital letter X as a separator between templates.

For example, set the OCR template as **99999XAAAAA** to decode OCR strings of either **12345** or **ABCDE**.

## Template Examples

Following are sample templates with descriptions of valid data for each definition.

Field Definition	Description
"M" 99977	<b>M</b> followed by three digits and two optional digits.



```
"X"997777"X"
```

**X** followed by two digits, four optional digits, and an X.

```
9959775599
```

Two digits followed by any character, a digit, two optional digits, any two characters, and two digits.

```
A55" - "999" - "99
```

A letter followed by two characters, a dash, three digits, a dash, and two digits.

```
33A" . "99
```

Two alphanumeric characters followed by a letter, a period, and two digits.

```
999992991
```

Five digits followed by an optional alpha, two digits, and an optional alphanumeric.

```
"PN98"
```

Literal field - **PN98**

## OCR Check Digit Modulus

### Parameter # 688 (SSI # F1h B0h)

This parameter sets the OCR module check digit calculation.

The check digit is the last digit (in the right-most position) in an OCR string and improves the accuracy of the collected data. The calculation is performed on incoming data to determine this check digit, based on the numeric weight of the alpha and numeric characters. See [OCR Check Digit Multiplier](#). If the incoming data does not match the check digit, the data is considered corrupt.

The selected check digit option does not take effect until you set [OCR Check Digit Validation](#).

To choose the Check Digit Modulus, such as 10 for Modulus 10, scan OCR Check Digit, and then scan a three-digit number from 001 to 099 representing the check digit using the numeric keypad in [Numeric Barcodes](#).

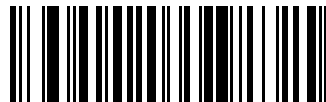

OCR Check Digit

## OCR Check Digit Multiplier

### Parameter # 700 (SSI # F1h BCh)

This parameter sets OCR check digit multipliers for character positions.

For check digit validation, each character in scanned data has an assigned weight to use in calculating the check digit. The scanner OCR ships with the following weight equivalents:

0 = 0

A = 10

K = 20

U = 30

1 = 1	B = 11	L = 21	V = 31
2 = 2	C = 12	M = 22	W = 32
3 = 3	D = 13	N = 23	X = 33
4 = 4	E = 14	O = 24	Y = 34
5 = 5	F = 15	P = 25	Z = 35
6 = 6	G = 16	Q = 26	Space = 0
7 = 7	H = 17	R = 27	
8 = 8	I = 18	S = 28	
9 = 9	J = 19	T = 29	

All other characters are equivalent to one (1).

You can define the multiplier string if it is different from the default.



**NOTE:** 123456789A (for ISBN, Product Add Right to Left. See [OCR Check Digit Validation](#))

For example:

ISBN	0	2	0	1	1	8	3	9	9	4
Multiplier	10	9	8	7	6	5	4	3	2	1
Product	0	18	0	7	6	40	12	27	18	4
Product add	0+	18+	0+	7+	6+	40+	12+	27+	18+	4= 132

ISBN uses Modulus 11 for the check digit. In this case, 132 is divisible by 11, so it passes the check digit.

To set the check digit multiplier, scan OCR Check Digit Multiplier, and then scan numbers and letters to form the multiplier string before scanning End of Message from [Alphanumeric Barcodes](#)



OCR Check Digit Multiplier

## OCR Check Digit Validation

### Parameter # 694 (SSI # F1h B6h)

This parameter protects against scanning errors by applying a check digit validation scheme.

#### None

No check digit validation, indicating no check digit is applied.



\*No Check Digit (0)

## Product Add Left to Right

This parameter helps validate the check digit.

Each character in the scanned data is assigned a numeric value (see [OCR Check Digit Multiplier](#)). Each digit representing a character in the scanned data is multiplied by its corresponding digit in the multiplier, and the sum of these products is computed. The check digit passes if this sum modulo Check Digit Modulus is zero.

For example:

Scanned data numeric value is 132456 (check digit is 6)

Check digit multiplier string is 123456

Digit	1	3	2	4	5	6	
Multiplier	1	2	3	4	5	6	
Product	1	6	6	16	25	36	
Product add	1+	6+	6+	16+	25+	36=	90

The Check Digit Modulus is 10. It passes because 90 is divisible by 10 (the remainder is zero).

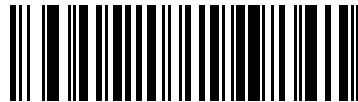

Product Add Left to Right (3)

## Product Add Right to Left

This parameter changes the order of the numeric values the check digit multiplier uses with the Check Digit Modulus.

Each character in the scanned data is assigned a numeric value (see [OCR Check Digit Multiplier](#)). The check digit multiplier is reversed in order. Each value representing a character in the scanned data is multiplied by its corresponding digit in the reversed multiplier, resulting in a product for each character in the scanned data. The sum of these products is computed. The check digit passes if this sum modulo Check Digit Modulus is zero.

For example:

Scanned data numeric value is 132459 (check digit is 9)

Check digit multiplier string is 123456

Digit	1	3	2	4	5	9	
Multiplier	6	5	4	3	2	1	
Product	6	15	8	12	10	9	
Product add	6+	15+	8+	12+	10+	9=	60

The Check Digit Modulus is 10. It passes because 60 is divisible by 10 (the remainder is 0).



Product Add Right to Left (1)

## Digit Add Left to Right

This parameter adds individual digits from left to right to use in the Check Digit Modulus.

Each character in the scanned data is assigned a numeric value (see [OCR Check Digit Multiplier](#)). Each value representing a character in the scanned data is multiplied by its corresponding digit in the multiplier, resulting in a product for each character in the scanned data. The sum of each individual digit in all of the products is then calculated. The check digit passes if this sum modulo Check Digit Modulus is zero.

For example:

Scanned data numeric value is 132456 (check digit is 6)

Check digit multiplier string is 123456

Digit	1	3	2	4	5	6	
Multiplier	1	2	3	4	5	6	
Product	1	6	6	16	25	36	
Digit add	1+	6+	6+	1+6+	2+5+	3+6=	36

The Check Digit Modulus is 12. It passes because 36 is divisible by 12 (the remainder is 0).

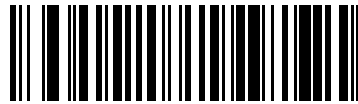

Digit Add Left to Right (4)

## Digit Add Right to Left

This parameter adds individual digits from right to left to use in the Check Digit Modulus.

Each character in the scanned data is assigned a numeric value (see [OCR Check Digit Multiplier](#)). The check digit multiplier is reversed in order. Each value representing a character in the scanned data is multiplied by its corresponding digit in the reversed multiplier, resulting in a product for each character in the scanned data. The sum of each individual digit in all of the products is then calculated. The check digit passes if this sum modulo Check Digit Modulus is zero.

For example:

Scanned data numeric value is 132456 (check digit is 6)

Check digit multiplier string is 123456

Digit	1	3	2	4	5	6	
Multiplier	6	5	4	3	2	1	
Product	6	15	8	12	10	6	
Digit add	6+	1+5+	8+	1+2+	1+0+	6=	30

The Check Digit Modulus is 10. It passes because 30 is divisible by 10 (the remainder is 0).



Digit Add Right to Left (2)

### Product Add Right to Left Simple Remainder

This parameter reverses the order of the check digit multiplier before adding the product to use in the Check Digit Modulus.

Each character in the scanned data is assigned a numeric value (see [OCR Check Digit Multiplier](#)). The check digit multiplier is reversed in order. Each value representing a character in the scanned data is multiplied by its corresponding digit in the reversed multiplier, resulting in a product for each character in the scanned data. The sum of these products **except for the check digit's product** is computed. The check digit passes if this sum modulo Check Digit Modulus is equal to the check digit's product.

For example:

Scanned data numeric value is 122456 (check digit is 6)

Check digit multiplier string is 123456

Digit	1	2	2	4	5	6
Multiplier	6	5	4	3	2	1
Product	6	10	8	12	10	6
Product add	6+	10+	8+	12+	10=	46

The Check Digit Modulus is 10. It passes because 46 divided by 10 leaves a remainder of 6.

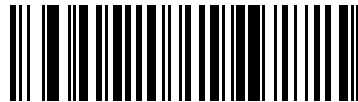

Product Add Right to Left Simple Remainder (5)

### Digit Add Right To Left Simple Remainder

This parameter reverses the order of the check digit multiplier before adding the product and checking the remainder to use in the Check Digit Modulus.

Each character in the scanned data is assigned a numeric value (see [OCR Check Digit Multiplier](#)). The check digit multiplier is reversed in order. Each value representing a character in the scanned data is multiplied by its corresponding digit in the reversed multiplier, resulting in a product for each character in the scanned data. The sum of each individual digit in all of the products **except for the check digit's product** is then calculated. The check digit passes if this sum modulo Check Digit Modulus is equal to the check digit's product.

For example:

Scanned data numeric value is 122459 (check digit is 6) Check digit multiplier string is 123456

Digit	1	2	2	4	5	9
Multiplier	6	5	4	3	2	1

Product	6	10	8	12	10		9
Digit add	6+	1+0+	8+	1+2+	1+0=	19	9

The Check Digit Modulus is 10. It passes because 19 divided by 10 leaves a remainder of 9.



Digit Add Right to Left Simple Remainder (6)

### Health Industry - HIBCC43

This parameter is the health industry module 43 check digit standard.

The check digit is the modulus 43 sum of all the character values in a given message, and is printed as the last character in a given message.

Example:

Supplier Labelling Data Structure: + A 1 2 3 B J C 5 D 6 E 7 1

Sum of values: 41+10+1+2+3+11+19+12+5+13+6+14+7+1 = 145

Divide 145 by 43. The quotient is 3 with a remainder of 16. The check digit is the character corresponding to the value of the remainder, which in this example is 16, or G. The complete Supplier Labeling Data Structure, including the check digit, therefore is:

A 1 2 3 B J C 5 D 6 E 7 1 G

#### Numeric Value Assignments for Computing HIBC LIC Data Format Check Digit

0 = 0	9 = 9	I = 18	R = 27	- = 36
1 = 1	A = 10	J = 19	S = 28	. = 37
2 = 2	B = 11	K = 20	T = 29	Space = 38
3 = 3	C = 12	L = 21	U = 30	\$ = 39
4 = 4	D = 13	M = 22	V = 31	/ = 40
5 = 5	E = 14	N = 23	W = 32	+ = 41
6 = 6	F = 15	O = 24	X = 33	% = 42
7 = 7	G = 16	P = 25	Y = 34	
8 = 8	H = 17	Q = 26	Z = 35	



Health Industry - HIBCC43 (9)

### Inverse OCR

Parameter # 856 (SSI # F2h 58h)

This parameter can read white or light words on a black or dark background.

- Regular Only - Decode regular OCR (black on white) strings only.
- Inverse Only - Decode inverse OCR (white on black) strings only.
- Autodiscriminate - Decode both regular and inverse OCR strings.

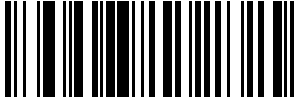

\*Regular Only (0)

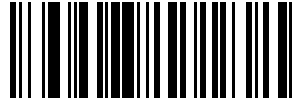

Inverse Only (1)

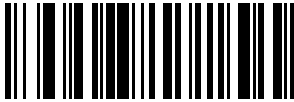

Autodiscriminate (2)

## OCR Redundancy

### Parameter # 1770 (SSI # F8h 06h EAh)

This parameter adjusts the number of times to decode an OCR text string before transmission.

There are three levels of OCR decode redundancy. There is an inverse relationship between the redundancy level and OCR decoding aggressiveness. Increasing the level of the redundancy can reduce OCR scanning aggressiveness, so select only the level of redundancy necessary.

- OCR Redundancy Level 1 - This setting allows the scanner to operate in its most aggressive state while providing sufficient accuracy in decoding most in-spec OCR text strings.
- OCR Redundancy Level 2 - This setting eliminates most misdecodes while maintaining reasonable aggressiveness.
- OCR Redundancy Level 3 - Select this option with greater redundancy requirements if OCR Redundancy Level 2 fails to eliminate misdecodes.



\*OCR Redundancy Level 1 (1)



OCR Redundancy Level 2 (2)



OCR Redundancy Level 3 (3)



# Numeric Barcodes

For parameters requiring specific numeric values, scan the appropriately numbered barcode(s).

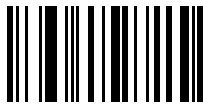

0

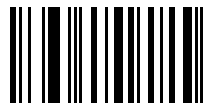

1

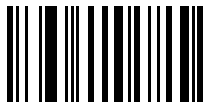

2



3

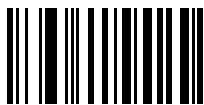

4



5

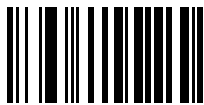

6



7



8



9

## Cancel

To correct an error or change a selection, scan the barcode below.

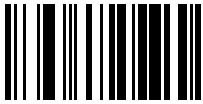

Cancel

# Alphanumeric Barcodes

For parameters requiring specific alphanumeric values, scan the appropriately numbered barcode(s).

## Cancel

To correct an error or change a selection, scan the barcode below.

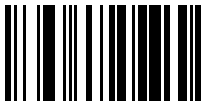

Cancel

## Alphanumeric Barcodes

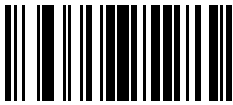

Space

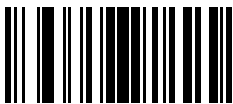

\$

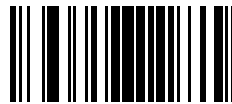

#

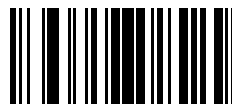

%

# Alphanumeric Barcodes



\*



+



-

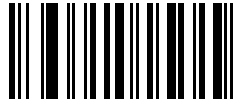

.



/

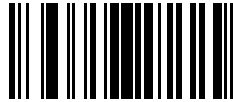

!

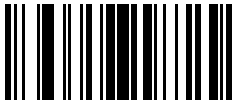

“

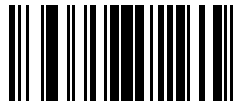

&

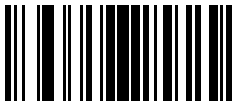

<

# Alphanumeric Barcodes



)

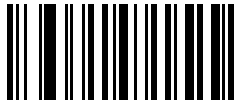

;



=



?

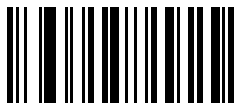

[



(



:



<



>

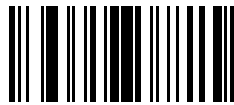

@

# Alphanumeric Barcodes



\



]



^

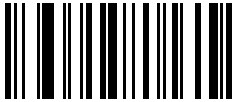

-

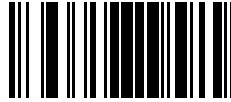

`



**NOTE:** Do not confuse the following barcodes with those on the numeric keypad.



0

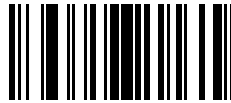

1

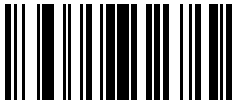

2

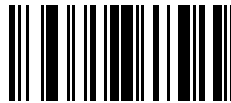

3

# Alphanumeric Barcodes



4



5

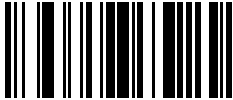

6

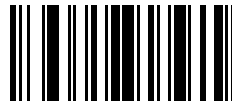

7

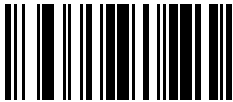

8



9

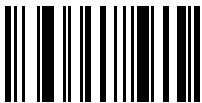

End of Message



Cancel



A

# Alphanumeric Barcodes



C



E



G



I



K



B

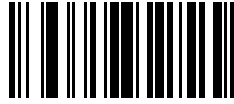

D

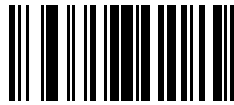

F

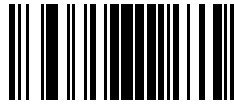

H



J



# Alphanumeric Barcodes



M

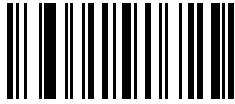

O

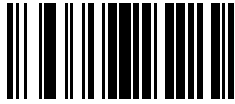

Q

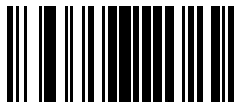

S



L

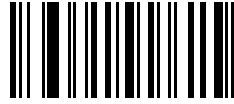

N

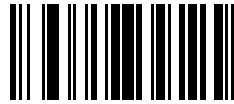

P

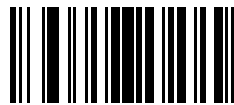

R

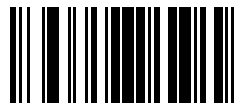

T

# Alphanumeric Barcodes



U



V



W

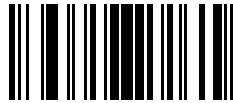

X

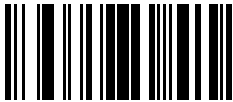

Y

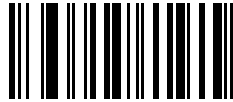

Z

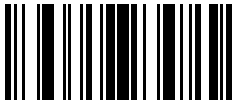

a

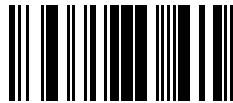

b



c



d

# Alphanumeric Barcodes



e

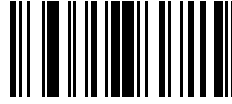

f



g



h



i

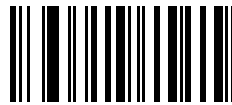

j

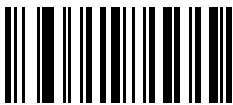

k

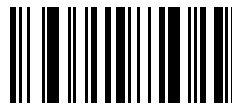

l



m

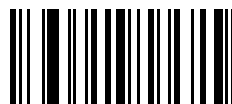

n

# Alphanumeric Barcodes



o



p



q

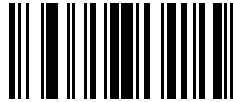

r

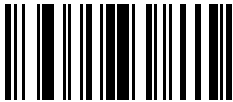

s

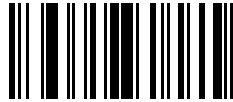

t



u



v

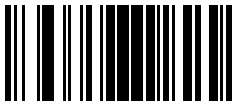

w

# Alphanumeric Barcodes



y

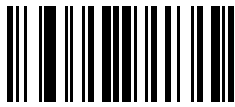

{



}



x

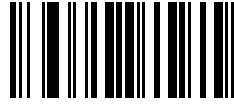

z

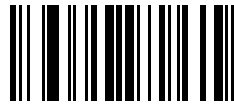

|

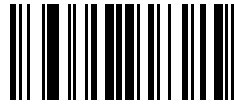

~

# ASCII Character Sets



**NOTE:** For the Keyboard Wedge Interface, Code 39 Full ASCII interprets the barcode special character (\$ + % /) preceding a Code 39 character and assigns an ASCII character value to the pair. For example, if you enable Code 39 Full ASCII and scan +B, it transmits as b, %J as ?, and %V as @. Scanning ABC%i outputs the keystroke equivalent of ABC >.

ASCII Value (Prefix/ Suffix Value)	Full ASCII Code 39 Encode Char	Keystroke	ASCII Character (Applies to RS-232 Only)
1000	%U	CTRL 2	NUL
1001	\$A	CTRL A	SOH
1002	\$B	CTRL B	STX
1003	\$C	CTRL C	ETX
1004	\$D	CTRL D	EOT
1005	\$E	CTRL E	ENQ
1006	\$F	CTRL F	ACK
1007	\$G	CTRL G	BELL
1008	\$H	CTRL H/ <b>BACKSPACE</b> <sup>a</sup>	BCKSPC
1009	\$I	CTRL I/ <b>HORIZONTAL TAB</b> <sup>d</sup>	HORIZ TAB
1010	\$J	CTRL J	LF/NW LN
1011	\$K	CTRL K	VT
1012	\$L	CTRL L	FF
1013	\$M	CTRL M/ <b>ENTER</b> <sup>c</sup>	CR/ENTER
1014	\$N	CTRL N	SO
1015	\$O	CTRL O	SI
1016	\$P	CTRL P	DLE
1017	\$Q	CTRL Q	DC1/XON
1018	\$R	CTRL R	DC2
1019	\$S	CTRL S	DC3/XOFF
1020	\$T	CTRL T	DC4
1021	\$U	CTRL U	NAK

## ASCII Character Sets

ASCII Value (Prefix/ Suffix Value)	Full ASCII Code 39 Encode Char	Keystroke	ASCII Character (Applies to RS-232 Only)
1022	\$V	CTRL V	SYN
1023	\$W	CTRL W	ETB
1024	\$X	CTRL X	CAN
1025	\$Y	CTRL Y	EM
1026	\$Z	CTRL Z	SUB
1027	%A	CTRL [	ESC
1028	%B	CTRL \	FS
1029	%C	CTRL ]	GS
1030	%D	CTRL 6	RS
1031	%E	CTRL -	US
1032	Space	Space	Space
1033	/A	!	!
1034	/B	"	"
1035	/C	#	#
1036	/D	\$	\$
1037	/E	%	%
1038	/F	&	&
1039	/G	'	'
1040	/H	(	(
1041	/I	)	)
1042	/J	*	*
1043	/K	+	+
1044	/L	,	,
1045	-	-	-
1046	.	.	.
1047	/o	/	/
1048	0	0	0
1049	1	1	1
1050	2	2	2
1051	3	3	3
1052	4	4	4
1053	5	5	5
1054	6	6	6
1055	7	7	7
1056	8	8	8

## ASCII Character Sets

ASCII Value (Prefix/ Suffix Value)	Full ASCII Code 39 Encode Char	Keystroke	ASCII Character (Applies to RS-232 Only)
1057	9	9	9
1058	/Z	:	:
1059	%F	;	;
1060	%G	<	<
1061	%H	=	=
1062	%I	>	>
1063	%J	?	?
1064	%V	@	@
1065	A	A	A
1066	B	B	B
1067	C	C	C
1068	D	D	D
1069	E	E	E
1070	F	F	F
1071	G	G	G
1072	H	H	H
1073	I	I	I
1074	J	J	J
1075	K	K	K
1076	L	L	L
1077	M	M	M
1078	N	N	N
1079	O	O	O
1080	P	P	P
1081	Q	Q	Q
1082	R	R	R
1083	S	S	S
1084	T	T	T
1085	U	U	U
1086	V	V	V
1087	W	W	W
1088	X	X	X
1089	Y	Y	Y
1090	Z	Z	Z
1091	%K	[	[



## ASCII Character Sets

ASCII Value (Prefix/ Suffix Value)	Full ASCII Code 39 Encode Char	Keystroke	ASCII Character (Applies to RS-232 Only)
1092	%L	\	\
1093	%M	]	]
1094	%N	^	^
1095	%O	_	_
1096	%W	`	`
1097	+A	a	a
1098	+B	b	b
1099	+C	c	c
1100	+D	d	d
1101	+E	e	e
1102	+F	f	f
1103	+G	g	g
1104	+H	h	h
1105	+I	i	i
1106	+J	j	j
1107	+K	k	k
1108	+L	l	l
1109	+M	m	m
1110	+N	n	n
1111	+O	o	o
1112	+P	p	p
1113	+Q	q	q
1114	+R	r	r
1115	+S	s	s
1116	+T	t	t
1117	+U	u	u
1118	+V	v	v
1119	+W	w	w
1120	+X	x	x
1121	+Y	y	y
1122	+Z	z	z
1123	%P	{	{
1124	%Q		
1125	%R	}	}
1126	%S	~	~

## ASCII Character Sets

ASCII Value (Prefix/ Suffix Value)	Full ASCII Code 39 Encode Char	Keystroke	ASCII Character (Applies to RS-232 Only)
1127			Undefined
7013			ENTER

- <sup>a</sup> The keystroke in bold transmits only if you enabled Function Key Mapping. Otherwise, the unbold keystroke transmits.
- <sup>b</sup> The keystroke in bold transmits only if you enabled Function Key Mapping. Otherwise, the unbold keystroke transmits.
- <sup>c</sup> The keystroke in bold transmits only if you enabled Function Key Mapping. Otherwise, the unbold keystroke transmits.

**Table 35** ALT Key Character Set

ALT Keys	Keystroke
2045	ALT -
2050	ALT 2
2054	ALT 6
2064	ALT @
2065	ALT A
2066	ALT B
2067	ALT C
2068	ALT D
2069	ALT E
2070	ALT F
2071	ALT G
2072	ALT H
2073	ALT I
2074	ALT J
2075	ALT K
2076	ALT L
2077	ALT M
2078	ALT N
2079	ALT O
2080	ALT P
2081	ALT Q
2082	ALT R
2083	ALT S
2084	ALT T
2085	ALT U

**Table 35** ALT Key Character Set (Continued)

ALT Keys	Keystroke
2086	ALT V
2087	ALT W
2088	ALT X
2089	ALT Y
2090	ALT Z
2091	ALT [
2092	ALT \
2093	ALT ]



**NOTE:** GUI Shift Keys - The Apple™ iMac keyboard has an apple key on either side of the space bar. Windows-based systems have a GUI key to the left of the left ALT key, and to the right of the right ALT key.

**Table 36** GUI Key Character Set

GUI Key	Keystroke
3000	Right Control Key
3048	GUI 0
3049	GUI 1
3050	GUI 2
3051	GUI 3
3052	GUI 4
3053	GUI 5
3054	GUI 6
3055	GUI 7
3056	GUI 8
3057	GUI 9
3065	GUI A
3066	GUI B
3067	GUI C
3068	GUI D
3069	GUI E
3070	GUI F
3071	GUI G
3072	GUI H

**Table 36** GUI Key Character Set (Continued)

GUI Key	Keystroke
3073	GUI I
3074	GUI J
3075	GUI K
3076	GUI L
3077	GUI M
3078	GUI N
3079	GUI O
3080	GUI P
3081	GUI Q
3082	GUI R
3083	GUI S
3084	GUI T
3085	GUI U
3086	GUI V
3087	GUI W
3088	GUI X
3089	GUI Y
3090	GUI Z

**Table 37** F Key Character Set

F Keys	Keystroke
5001	F 1
5002	F 2
5003	F 3
5004	F 4
5005	F 5
5006	F 6
5007	F 7
5008	F 8
5009	F 9
5010	F 10
5011	F 11
5012	F 12

**Table 37** F Key Character Set (Continued)

F Keys	Keystroke
5013	F 13
5014	F 14
5015	F 15
5016	F 16
5017	F 17
5018	F 18
5019	F 19
5020	F 20
5021	F 21
5022	F 22
5023	F 23
5024	F 24

# Programming Reference

This section provides symbol and AIM code identifiers.

## Symbol Code Identifiers

**Table 38** Symbol Code Characters

Code Character	Code Type
A	UPC-A, UPC-E, UPC-E1, EAN-8, EAN-13
B	Code 39, Code 32
C	Codabar
D	Code 128, ISBT 128, ISBT 128 Concatenated
E	Code 93
F	Interleaved 2 of 5
G	Discrete 2 of 5, or Discrete 2 of 5 IATA
H	Code 11
J	MSI
K	GS1-128
L	Bookland EAN
M	Trioptic Code 39
N	Coupon Code
R	GS1 DataBar Family
S	Matrix 2 of 5
T	UCC Composite, TLC 39
U	Chinese 2 of 5
X	ISSN EAN, PDF417, Macro PDF417, Micro PDF417
z	Aztec, Aztec Rune
P00	Data Matrix
P01	QR Code, MicroQR

**Table 38** Symbol Code Characters (Continued)

Code Character	Code Type
P02	Maxicode
P03	US Postnet
P04	US Planet
P05	Japan Postal
P06	UK Postal
P08	Netherlands KIX Code
P09	Australia Post
P0A	USPS 4CB/One Code/Intelligent Mail
P0B	UPU FICS Postal
P0C	Mailmark
P0D	Grid Matrix
P0G	GS1 Data Matrix
P0H	Han Xin
P0Q	GS1 QR
P0X	Signature Capture

## AIM Code Identifiers

Each AIM Code Identifier contains the three-character string ]cm where:

] = Flag Character (ASCII 93)

c = Code Character (see table below)

m = Modifier Character (see table below)

**Table 39** AIM Code Characters

Code Character	Code Type
A	Code 39, Code 39 Full ASCII, Code 32
C	Code 128, ISBT 128, ISBT 128 Concatenated, GS1-128, Coupon (Code 128 portion)
d	Data Matrix, GS1 Data Matrix
E	UPC/EAN, Coupon (UPC portion)
e	GS1 DataBar Family

**Table 39** AIM Code Characters (Continued)

Code Character	Code Type
F	Codabar
G	Code 93
g	Grid Matrix
H	Code 11
h	Han Xin
I	Interleaved 2 of 5
L	PDF417, Macro PDF417, Micro PDF417
L2	TLC 39
M	MSI
Q	QR Code, MicroQR, GS1 QR
S	Discrete 2 of 5, IATA 2 of 5
U	Maxicode
z	Aztec, Aztec Rune
X	Bookland EAN, ISSN EAN, Trioptic Code 39, Chinese 2 of 5, Matrix 2 of 5, Korean 3 of 5, US Postnet, US Planet, UK Postal, Japan Postal, Australia Post, Netherlands KIX Code, USPS 4CB/One Code/ Intelligent Mail, UPU FICS Postal, Mailmark, Signature Capture

The modifier character is the sum of the applicable option values based on the following table.

**Table 40** Modifier Characters

Code Type	Option Value	Option
Code 39	0	No check character or Full ASCII processing.
	1	Reader has checked one check character.
	3	Reader has checked and stripped check character.
	4	Reader has performed Full ASCII character conversion.
	5	Reader has performed Full ASCII character conversion and checked one check character.
	7	Reader has performed Full ASCII character conversion and checked and stripped check character.
	Example: A Full ASCII barcode with check character W, A+I+MI+DW, is transmitted as JA7AIMID where 7 = (3+4).	
Trioptic Code 39	0	No option specified at this time. Always transmit 0.
	Example: A Trioptic barcode 412356 is transmitted as JX0412356	
Code 128	0	Standard data packet, no Function code 1 in first symbol position.
	1	Function code 1 in first symbol character position.
	2	Function code 1 in second symbol character position.



**Table 40** Modifier Characters (Continued)

Code Type	Option Value	Option
		Example: A Code (EAN) 128 barcode with Function 1 character FNC1 in the first position, AIMID is transmitted as ]C1AIMID
I 2 of 5	0	No check digit processing.
	1	Reader has validated check digit.
	3	Reader has validated and stripped check digit.
		Example: An I 2 of 5 barcode without check digit, 4123, is transmitted as ]I04123
Codabar	0	No check digit processing.
	1	Reader has checked check digit.
	3	Reader has stripped check digit before transmission.
		Example: A Codabar barcode without check digit, 4123, is transmitted as ]F04123
Code 93	0	No options specified at this time. Always transmit 0.
		Example: A Code 93 barcode 012345678905 is transmitted as ]G0012345678905
MSI	0	Check digits are sent.
	1	No check digit is sent.
		Example: An MSI barcode 4123, with a single check digit checked, is transmitted as ]M14123
D 2 of 5	0	No options specified at this time. Always transmit 0.
		Example: A D 2 of 5 barcode 4123, is transmitted as ]S04123
UPC/EAN	0	Standard data packet in full EAN format, i.e., 13 digits for UPC-A, UPC-E, and EAN-13 (not including supplemental data).
	1	Two digit supplemental data only.
	2	Five digit supplemental data only.
	3	Combined data packet comprising 13 digits from EAN-13, UPC-A or UPC-E symbol and 2 or 5 digits from supplemental symbol.
	4	EAN-8 data packet.
		Example: A UPC-A barcode 012345678905 is transmitted as ]E0012345678905
Bookland EAN	0	No options specified at this time. Always transmit 0.
		Example: A Bookland EAN barcode 123456789X is transmitted as ]X0123456789X
ISSN EAN	0	No options specified at this time. Always transmit 0.
		Example: An ISSN EAN barcode 123456789X is transmitted as ]X0123456789X
Code 11	0	Single check digit
	1	Two check digits
	3	Check characters validated but not transmitted.

**Table 40** Modifier Characters (Continued)

Code Type	Option Value	Option
GS1 DataBar Family		No option specified at this time. Always transmit 0. GS1 DataBar Omnidirectional and GS1 DataBar Limited transmit with an Application Identifier "01". Note: In GS1-128 emulation mode, GS1 DataBar is transmitted using Code 128 rules (i.e., ]C1).
		Example: A GS1 DataBar Omnidirectional barcode 0110012345678902 is transmitted as ]e00110012345678902.
EAN.UCC Composites (GS1 DataBar, GS1-128, 2D portion of UPC composite)		Native mode transmission.  <b>NOTE:</b> UPC portion of composite is transmitted using UPC rules.
	0	Standard data packet.
	1	Data packet containing the data following an encoded symbol separator character.
	2	Data packet containing the data following an escape mechanism character. The data packet does not support the ECI protocol.
	3	Data packet containing the data following an escape mechanism character. The data packet supports the ECI protocol.
		GS1-128 emulation Note: UPC portion of composite is transmitted using UPC rules.
	1	Data packet is a GS1-128 symbol (i.e., data is preceded with ]JC1).
PDF417, Micro PDF417	0	Reader set to conform to protocol defined in 1994 PDF417 symbology specifications. Note: When this option is transmitted, the receiver cannot reliably determine whether ECIs have been invoked or whether data byte 92DEC has been doubled in transmission.
	1	Reader set to follow the ECI protocol (Extended Channel Interpretation). All data characters 92DEC are doubled.
	2	Reader set for Basic Channel operation (no escape character transmission protocol). Data characters 92DEC are not doubled. Note: When decoders are set to this mode, unbuffered Macro symbols and symbols requiring the decoder to convey ECI escape sequences cannot be transmitted.
	3	The barcode contains a GS1-128 symbol, and the first codeword is 903-907, 912, 914, 915.
	4	The barcode contains a GS1-128 symbol, and the first codeword is in the range 908-909.
	5	The barcode contains a GS1-128 symbol, and the first codeword is in the range 910-911.
		Example: A PDF417 barcode ABCD, with no transmission protocol enabled, is transmitted as ]L2ABCD.
Data Matrix	0	ECC 000-140, not supported.
	1	ECC 200.
	2	ECC 200, FNC1 in first or fifth position.
	3	ECC 200, FNC1 in second or sixth position.

**Table 40** Modifier Characters (Continued)

Code Type	Option Value	Option
	4	ECC 200, ECI protocol implemented.
	5	ECC 200, FNC1 in first or fifth position, ECI protocol implemented.
	6	ECC 200, FNC1 in second or sixth position, ECI protocol implemented.
GS1 Data Matrix	2	ECC 200, FNC1 in first or fifth position.
MaxiCode	0	Symbol in Mode 4 or 5.
	1	Symbol in Mode 2 or 3.
	2	Symbol in Mode 4 or 5, ECI protocol implemented.
	3	Symbol in Mode 2 or 3, ECI protocol implemented in secondary message.
QR Code	0	Model 1 symbol.
	1	Model 2 / MicroQR symbol, ECI protocol not implemented.
	2	Model 2 symbol, ECI protocol implemented.
	3	Model 2 symbol, ECI protocol not implemented, FNC1 implied in first position.
	4	Model 2 symbol, ECI protocol implemented, FNC1 implied in first position.
	5	Model 2 symbol, ECI protocol not implemented, FNC1 implied in second position.
	6	Model 2 symbol, ECI protocol implemented, FNC1 implied in second position.
GS1 QR	3	Model 2 symbol, ECI protocol not implemented, FNC1 implied in first position.
Aztec	0	Aztec symbol.
	C	Aztec Rune symbol.
Han Xin	0	Generic data, no special features are set. The transmitted data does not follow the AIM ECI protocol.
	1	ECI protocol enabled. There is at least one ECI mode encoded. Transmitted data must follow the AIM ECI protocol.
Mailmark	0	No option specified at this time. Always transmit 0.

# Standard Parameter Defaults

This section provides the standard parameter defaults.

Parameter	Parameter Number <sup>a</sup>	SSI Number <sup>b</sup>	Default
<b>USB Host Parameters</b>			
USB Device Type	N/A	N/A	USB HID Keyboard
Symbol Native API (SNAPI) Status Handshaking	N/A	N/A	Enable
USB Keystroke Delay	N/A	N/A	No Delay
USB Caps Lock Override	N/A	N/A	Disable
USB Barcodes with Unknown Characters	N/A	N/A	Send
USB Convert Unknown to Code 39	N/A	N/A	Disable
USB Fast HID	N/A	N/A	Enable
USB Polling Interval	N/A	N/A	3 msec
USB CDC Host Variant	1713	N/A	Standard USB CDC
Keypad Emulation	N/A	N/A	Enable
Quick Keypad Emulation	N/A	N/A	Enable
Keypad Emulation with Leading Zero	N/A	N/A	Enable
USB Keyboard FN1 Substitution	N/A	N/A	Disable
Function Key Mapping	N/A	N/A	Disable
Simulated Caps Lock	N/A	N/A	Disable
Convert Case	N/A	N/A	None
USB Static CDC	N/A	N/A	Enable
CDC Beep on <BEL>	150	N/A	Enable
TGCS (IBM) USB Beep Directive	N/A	N/A	Disable
TGCS (IBM) USB Barcode Configuration Directive	N/A	N/A	Enable
TGCS (IBM) USB Specification Version	1729	N/A	2.2
<b>SSI Host Parameters</b>			

## Standard Parameter Defaults

Parameter	Parameter Number <sup>a</sup>	SSI Number <sup>b</sup>	Default
Select SSI Host	N/A	N/A	N/A
SSI Baud Rate	156	9Ch	9600
SSI Parity	158	9Eh	None
Check Parity	151	97h	Do Not Check
SSI Stop Bits	157	9Dh	1 Stop Bit
Intercharacter Delay	N/A	N/A	0 msec
Host RTS Line State	154	9Ah	Low
Software Handshaking	159	9Fh	ACK/NAK
Decode Data Packet Format	238	EEh	Send Raw Decode Data
Host Serial Response Timeout	155	9Bh	2 sec
Host Character Timeout	239	EFh	200 msec
Multipacket Option	334	F0h 4Eh	Multipacket Option 1
Interpacket Delay	335	F0h 4Fh	0 msec
Host Serial Response Timeout	N/A	N/A	2 sec
<b>Event Reporting</b>			
Decode Event	256	F0h 00h	Disable
Boot Up Event	258	F0h 02h	Disable
Parameter Event	259	F0h 03h	Disable
<b>RS-232 Parameters</b>			
RS-232 Host Types	N/A	N/A	Standard
RS-232 Baud Rate	N/A	N/A	9600
Parity	N/A	N/A	None
Stop Bits	N/A	N/A	1 Stop Bit
Data Bits	N/A	N/A	8-bit
Check Receive Errors	N/A	N/A	Enable
Hardware Handshaking	N/A	N/A	None
Software Handshaking	N/A	N/A	None
Host Serial Response Timeout	N/A	N/A	2 sec
RTS Line State	N/A	N/A	Low RTS
Beep on <BEL>	N/A	N/A	Disable
Interchange Delay	N/A	N/A	0 msec
Nixdorf Beep/LED Options	N/A	N/A	Normal Operation
Barcodes with Unknown Characters	N/A	N/A	Enable
Datalogic Host Format	2253	F8 08 CD	Enable

## Standard Parameter Defaults

Parameter	Parameter Number <sup>a</sup>	SSI Number <sup>b</sup>	Default
Datalogic Supported Commands	2260	F8 08 D4	Disable
NCR Enable/Disable Alternate Beep Volume for Not on File Event	2384	N/A	Disable
NCR Not on File Beeper Volume	2383	N/A	Low Volume
NCR Use Prefix	1238	N/A	Enable
NCR Prefix	1282	N/A	1002 (STX)
NCR Suffix	1283	N/A	1003 (ETX)
NCR Use Block Check Character	1239	N/A	Enable
NCR 2D Label-ID Mode	1948	N/A	NCR Mode
<b>User Preferences</b>			
Set Default Parameter	N/A	N/A	N/A
Parameter Barcode Scanning	236	ECh	Enable
Lock Parameter Scanning	802	F2h 22h	Disable
Unlock Parameter Scanning	803	F2h 23h	Disable
Beep After Good Decode	56	38h	Enable
Beep on <BEL>	150	96h	Enable
Beeper Volume	140	8Ch	High
Scan Tone	145	91h	Medium
Beeper Duration	628	F1h 74h	Medium
Suppress Power-Up Beeps	721	F1h D1h	Do Not Suppress
LED on Good Decode	744	F1h E	Enable
Low Power Mode	128	80h	Disable
Time Delay to Low Power Mode	146	92h	1 Hour
Trigger Mode	138	8Ah	Presentation Mode
Hand-held Decode Aiming Pattern	306	F0h 32h	Enable
Hands-free (Presentation) Decode Aiming Pattern	590	F1h 4Eh	Enable Hands-free (Presentation) Decode Aiming Pattern on PDF
Momentary Trigger Mode Timeout	2030	EDh	5 sec
Picklist Mode	402	F0h 92h	Disable Picklist Mode Always
Decode Session Timeout	136	88h	9.9 sec
Continuous Barcode Read	649	F1h 89h	Disable
Unique Barcode Reporting	723	F1h D3h	Enable
Hands-Free Decode Session Timeout	400	F0h 90h	15
Timeout Between Decodes, Same Symbol	137	89h	0.5 sec

## Standard Parameter Defaults

Parameter	Parameter Number <sup>a</sup>	SSI Number <sup>b</sup>	Default
Timeout Between Decodes, Different Symbol	144	90h	0.1 sec
Mobile Phone/Display Mode	716	F1h CCh	Disable
Motion Detect Mode (Wakeup)	2377	F8 09 49	Object Detect
PDF Prioritization	719	F4h F1h CFh	Disable
PDF Prioritization Timeout	720	F1h D0h	200 ms
Presentation Mode Field of View	609	F1h 61h	Full
Mirrored Image	624	F1h 70h	Disable
Decoding Illumination	298	F0h 2Ah	Enable
Illumination Brightness	669	F1h 9Dh	High
Low Light Scene Detection	810	F2h 2Ah	Disable
Product ID (PID) Type	1281	F8h 05h 01h	Host Type Unique
Product ID (PID) Value	1725	S8h 06h BDh	0
Alternate Numeric Keypad Emulation	N/A	N/A	Enable
<b>Miscellaneous Options</b>			
Enter Key	N/A	N/A	N/A
Tab Key	N/A	N/A	N/A
Transmit Code ID Character	45	2Dh	None
Prefix Value	99, 105	63h 69h	7013 <CR><LF>
Suffix 1 Value	98, 104	62h, 68h	7013 <CR><LF>
Suffix 2 Value	100, 106	64h, 6Ah	
Scan Data Transmission Format	235	EBh	Data As Is
FN1 Substitution Values	103, 109	67h, 6Dh	7013 <CR><LF>
Transmit "No Read" Message	94	5E	Disable
Unsolicited Heartbeat Interval	1118	F8h 04h 5Eh	Disable
<b>Image Capture Preferences</b>			
Operational Modes	N/A	N/A	N/A
Image Capture Illumination	361	F0h 69h	Enable
Image Capture Autoexposure	360	F0h 68h	Enable
Fixed Exposure	567	F4h F1h 37h	100
Gain / Exposure Priority for Snapshot Mode	562	F1h 32h	Autodetect
Snapshot Mode Timeout	323	F0h 43h	30 sec
Snapshot Aiming Pattern	300	F0h 2Ch	Enable
Silence Operational Mode Changes	1293	F8h 05h 0Dh	Disable (do not silence)

## Standard Parameter Defaults

Parameter	Parameter Number <sup>a</sup>	SSI Number <sup>b</sup>	Default
Image Cropping	301	F0h 2Dh	Disable
Crop to Pixel Addresses	315 316 317 318	F4h F0h 3Bh F4h F0h 3Ch F4h F0h 3Dh F4h F0h 3Eh	0 top 0 left 799 bottom 1279 right
Image Size (Number of Pixels)	302	F0h 2Eh	Full
Image Brightness (Target White)	390	F0h 86h	180
JPEG Image Options	299	F0h 2Bh	Quality
JPEG Quality Value	305	F0h 31h	65
JPEG Size Value	561	F1h 31h	160 kB
Image Enhancement	564	F1h 34h	Low (1)
Image File Format Selection	304	F0h 30h	JPEG
Image Rotation	665	F1h 99h	0°
Bits per Pixel (BPP)	303	F0h 2Fh	8 BPP
Signature Capture	93	5Dh	Disable
Signature Capture Image File Format Selection	313	F0h 39h	JPEG
Signature Capture Bits per Pixel (BPP)	314	F0h 3Ah	8 BPP
Signature Capture Width	366	F4h F0h 6Eh	400
Signature Capture Height	367	F4h F0h 6Fh	100
Signature Capture JPEG Quality	421	F0h A5h	65
Video View Finder	324	F0h 44h	Disable
Video View Finder Image Size	329	F0h 49h	1700 bytes
<b>Symbologies</b>			
<b>Enable/Disable All Code Types</b>			
<b>1D Symbologies</b>			
<b>UPC/EAN/JAN</b>			
UPC-A	1	01h	Enable
UPC-E	2	02h	Enable
UPC-E1	12	0Ch	Disable
EAN-8/JAN 8	4	04h	Enable
EAN-13/JAN 13	3	03h	Enable
Bookland EAN	83	53h	Disable
Bookland ISBN Format	576	F1h 40h	ISBN-10
ISSN EAN	617	F1h 69h	Disable
Decode UPC/EAN/JAN Supplementals (2 and 5 digits)	16	10h	Ignore



## Standard Parameter Defaults

Parameter	Parameter Number <sup>a</sup>	SSI Number <sup>b</sup>	Default
User-Programmable Supplementals Supplemental 1: Supplemental 2:	579, 580	F4h F1h 43h F4h F1h 44h	000
UPC/EAN/JAN Supplemental Redundancy	80	50h	10
Decode UPC/EAN/JAN Supplemental AIM ID	672	F1h A0h	Combined
Transmit UPC-A Check Digit	40	28h	Enable
Transmit UPC-E Check Digit	41	29h	Enable
Transmit UPC-E1 Check Digit	42	2Ah	Enable
UPC-A Preamble	34	22h	System Character
UPC-E Preamble	35	23h	System Character
UPC-E1 Preamble	36	24h	System Character
Convert UPC-E to UPC-A	37	25h	Disable
Convert UPC-E1 to UPC-A	38	26h	Disable
EAN/JAN Zero Extend	39	27h	Disable
UCC Coupon Extended Code	85	55h	Disable
Coupon Report	730	F1h DAh	New Coupon Format
UPC Reduced Quiet Zone	1289	F8h 05h 09h	Disable
<b>Code 128</b>			
Code 128	8	08h	Enable
Set Length(s) for Code 128	209, 210	D1h, D2h	1 to 55
GS1-128 (formerly UCC/EAN-128)	14	0Eh	Enable
ISBT 128	84	54h	Enable
ISBT Concatenation	577	F1h 41h	Disable
Check ISBT Table	578	F1h 42h	Enable
ISBT Concatenation Redundancy	223	DFh	10
Ignore Code 128 <FNC4>	1254	F8h 04h E6h	Disable
Code 128 Security Level	751	F1h EFh	Security Level 1
Code 128 Reduced Quiet Zone	1208	F8h 04h B8h	Disable
<b>Code 39</b>			
Code 39	0	00h	Enable
Trioptic Code 39	13	0Dh	Disable
Convert Code 39 to Code 32	86	56h	Disable
Code 32 Prefix	231	E7h	Disable
Set Length(s) for Code 39	18, 19	12h, 13h	1 to 55
Code 39 Check Digit Verification	48	30h	Disable

## Standard Parameter Defaults

Parameter	Parameter Number <sup>a</sup>	SSI Number <sup>b</sup>	Default
Transmit Code 39 Check Digit	43	2Bh	Disable
Code 39 Full ASCII Conversion	17	11h	Disable
Code 39 Security Level	750	F1h EEh	Security Level 1
Code 39 Reduced Quiet Zone	1209	F8h 04h B9h	Disable
<b>Code 93</b>			
Code 93	9	09h	Enable
Set Length(s) for Code 93	26, 27	1Ah, 1Bh	1 to 55
<b>Code 11</b>			
Code 11	10	0Ah	Disable
Set Lengths for Code 11	28, 29	1Ch, 1Dh	4 to 55
Code 11 Check Digit Verification	52	34h	Disable
Transmit Code 11 Check Digit(s)	47	2Fh	Disable
<b>Interleaved 2 of 5 (ITF)</b>			
Interleaved 2 of 5 (ITF)	6	06h	Enable
Set Lengths for I 2 of 5	22, 23	16h, 17h	6 to 55
I 2 of 5 Check Digit Verification	49	31h	Disable
Transmit I 2 of 5 Check Digit	44	2Ch	Disable
Convert I 2 of 5 to EAN 13	82	52h	Disable
I 2 of 5 Security Level	1121	F8h 04h 61h	Security Level 1
I 2 of 5 Reduced Quiet Zone	1210	F8h 04h BAh	Disable
<b>Discrete 2 of 5 (DTF)</b>			
Discrete 2 of 5	5	05h	Disable
Set Length(s) for D 2 of 5	20, 21	14h 15h	1 to 55
<b>Codabar (NW - 7)</b>			
Codabar	7	07h	Enable
Set Lengths for Codabar	24, 25	18h, 19h	4 to 55
CLSI Editing	54	36h	Disable
NOTIS Editing	55	37h	Disable
Codabar Security Level	1776	F8h 06h F0h	Security Level 1
Codabar Upper or Lower Case Start/ Stop Characters Detection	855	F2h 57h	Upper Case
Codabar Mod 16 Check Digit Verification	1784	F8h 06h F8h	Disable
Transmit Codabar Check Digit	704	F1h C0h	Disable
<b>MSI</b>			

## Standard Parameter Defaults

Parameter	Parameter Number <sup>a</sup>	SSI Number <sup>b</sup>	Default
MSI	11	0Bh	Disable
Set Length(s) for MSI	30, 31	1Eh, 1Fh	4 to 55
MSI Check Digits	50	32h	One
Transmit MSI Check Digit	46	2Eh	Disable
MSI Check Digit Algorithm	51	33h	Mod 10/Mod 10
<b>Chinese 2 of 5</b>			
Chinese 2 of 5	408	F0h 98h	Disable
<b>Matrix 2 of 5</b>			
Matrix 2 of 5	618	F1h 6Ah	Disable
Matrix 2 of 5 Lengths	619 620	F1h 6Bh F1h 6Ch	4 to 55
Matrix 2 of 5 Check Digit	622	F1h 6Eh	Disable
Transmit Matrix 2 of 5 Check Digit	623	F1h 6Fh	Disable
<b>Korean 3 of 5</b>			
Korean 3 of 5	581	F1h 45h	Disable
Inverse 1D	586	F1h 4Ah	Regular
<b>GS1 DataBar</b>			
GS1 DataBar Omnidirectional	338	F0h 52h	Enable
GS1 DataBar Limited	339	F0h 53h	Enable
GS1 DataBar Expanded	340	F0h 54h	Enable
Convert GS1 DataBar to UPC/EAN/JAN	397	F0h 8Dh	Disable
GS1 DataBar Limited Margin Check	728	F1h D8h	Level 3
GS1 DataBar Security Level	1706	F8h 06h AAh	Security Level 1
<b>Symbology-Specific Security Features</b>			
Redundancy Level	78	4Eh	1
Security Level	77	4Dh	1
1D Quiet Zone Level	1288	F8h 05h 08h	1
Intercharacter Gap Size	381	F0h 7Dh	Normal
<b>Composite Codes</b>			
Composite CC-C	341	F0h 55h	Disable
Composite CC-A/B	342	F0h 56h	Disable
Composite TLC-39	371	F0h 73h	Disable
Composite Inverse	1113	F8h 04h 59h	Regular
UPC Composite Mode	344	F0h 58h	UPC Never Linked

## Standard Parameter Defaults

Parameter	Parameter Number <sup>a</sup>	SSI Number <sup>b</sup>	Default
Composite Beep Mode	398	F0h 8Eh	Beep As Each Code Type is Decoded
GS1-128 Emulation Mode for UCC/EAN Composite Codes	427	F0h ABh	Disable
<b>2D Symbolologies</b>			
PDF417	15	0Fh	Enable
MicroPDF417	227	E3h	Disable
Code 128 Emulation	123	7Bh	Disable
Data Matrix	292	F0h 24h	Enable
GS1 Data Matrix	1336	F8h 05h 38h	Disable
Data Matrix Inverse	588	F1h 4Ch	Inverse Autodetect
Maxicode	294	F0h 26h	Disable
QR Code	293	F0h 25h	Enable
GS1 QR	1343	F8h 05h 3Fh	Disable
MicroQR	573	F1h 3Dh	Enable
Linked QR Mode	1847	737h	Linked QR Only
Aztec	574	F1h 3Eh	Enable
Aztec Inverse	589	F1h 4Dh	Inverse Autodetect
Han Xin	1167	F8h 04h 8Fh	Disable
Han Xin Inverse	1168	F8h 04h 90h	Regular
Grid Matrix	1718	F8 06h B6h	Disable
Grid Matrix Inverse	1719	F8h 06h B7h	Regular
Grid Matrix Mirrored	1736	F8h 06h C8h	Non-Mirrored
DotCode	1906	F8 07 72h	Disable
DotCode Inverse	1907	F8 07 73h	Autodetect
DotCode Mirrored	1908	F8 07 74h	Autodetect
DotCode Prioritize	1937	F8 07 94h	Disable
DotCode Erasure Limit	2063	F8 08 0F	10
<b>Postal Codes</b>			
US Postnet	89	59h	Disable
US Planet	90	5Ah	Disable
Transmit US Postal Check Digit	95	5Fh	Enable
UK Postal	91	5Bh	Disable
Transmit UK Postal Check Digit	96	60h	Enable
Japan Postal	290	F0h 22h	Disable

## Standard Parameter Defaults

Parameter	Parameter Number <sup>a</sup>	SSI Number <sup>b</sup>	Default
Australia Post	291	F0h 23h	Disable
Australia Post Format	718	F1h CEh	Autodiscriminate
Netherlands KIX Code	326	F0h 46h	Disable
USPS 4CB/One Code/Intelligent Mail	592	F1h 50h	Disable
UPU FICS Postal	611	F1h 63h	Disable
Mailmark	1337	F8h 05h 39h	Disable
<b>Intelligent Document Capture</b>			
IDC Operating Mode	594	F1h 52h	Off
IDC Symbology	655	F1h 8Fh	001
IDC X Coordinate	596	F4h F1h 54h	-151
IDC Y Coordinate	597	F4h F1h 55h	-050
IDC Width	598	F1h 56h	0300
IDC Height	599	F1h 57h	0050
IDC Aspect	595	F1h 53h	000
IDC File Format Selector	601	F1h 59h	JPEG
IDC Bits Per Pixel	602	F1h 5Ah	8 BPP
IDC JPEG Quality	602	F1h 5Bh	065
IDC Find Box Outline	727	F1h D7h	Disable
IDC Minimum Text Length	656	F1h 90h	00
IDC Maximum Text Length	657	F1h 91h	00
IDC Captured Image Brighten	654	F1h 8Eh	Enable
IDC Captured Image Sharpen	658	F1h 92h	Enable
IDC Border Type	829	F2h 3Dh	None
IDC Delay Time	830	F2h 3Eh	000
IDC Zoom Limit	651	F1h 8Bh	000
IDC Maximum Rotation	652	F1h 8Ch	00
<b>OCR Programming</b>			
OCR-A	680	F1h A8h	Disable
OCR-A Variant	684	F1h ACh	Full ASCII
OCR-B	681	F1h A9h	Disable
OCR-B Variant	685	F1h ADh	Full ASCII
MICR E13B	682	F1h AAh	Disable
US Currency	683	F1h ABh	Disable
OCR Orientation	687	F1h AFh	0°

## Standard Parameter Defaults

Parameter	Parameter Number <sup>a</sup>	SSI Number <sup>b</sup>	Default
OCR Lines	691	F1h B3h	1
OCR Minimum Characters	689	F1h B1h	3
OCR Maximum Characters	690	F1h B2h	100
OCR Subset	686	F1h AEh	Selected font variant
OCR Quiet Zone	695	F1h B7h	50
OCR Bright Illumination	701	F1h BDh	Disable
OCR Template	547	F1h 23h	99999999
OCR Check Digit Modulus	688	F1h B0h	1
OCR Check Digit Multiplier	700	F1h BCh	1212121212
OCR Check Digit Validation	694	F1h B6h	None
Inverse OCR	856	F2h 58h	Regular
OCR Redundancy	1770	F8h 06h EAh	Level 1
<b>DL Parsing Parameters</b>			
Driver's License Parsing	N/A	N/A	No Driver's License Parsing
Parsing Driver's License Data Fields	N/A	N/A	N/A
Driver's License Parse Rules	N/A	N/A	N/A
AAMVA Parse Field Barcodes	N/A	N/A	N/A
Set Default Parameter	N/A	N/A	N/A
Output Gender as M or F	N/A	N/A	N/A
Date Format	N/A	N/A	CCYYMMDD
No Separator	N/A	N/A	N/A
Send Keystroke Control Characters Keyboard Characters	N/A	N/A	N/A
Parsing Rule Example	N/A	N/A	N/A
Embedded Driver's License Parsing ADF Example	N/A	N/A	N/A
<b>Country Code Parameters</b>			
Country Code Barcodes	N/A	N/A	US English (North American)
Country Code Page Barcodes	961	N/A	N/A
<b>CJK Decode Control Parameters</b>			
Unicode Output Control	973	N/A	Universal
CJK Output Method to Windows Host	972	N/A	Universal
Non-CJK UTF Barcode Output	960	N/A	N/A

<sup>a</sup> Parameter number decimal values are used for programming via RSM commands.

<sup>b</sup> SSI number hex values are used for programming via SSI commands.

# Country Codes

This section provides instructions for programming the keyboard to interface with a USB or keyboard wedge host.

The host powers the scanner. For host setup information, see and .

To select a code page for the country keyboard type, see [Country Code Barcodes](#).

Throughout the programming barcode menus, default values are indicated with asterisks (\*).

## USB and Keyboard Wedge Country Keyboard Types (Country Codes)

Scan the barcode corresponding to the keyboard type. For a USB host, this setting applies only to the USB Keyboard (HID) device. If the keyboard type is not listed, see [Keypad Emulation](#) for the USB HID host. For a keyboard wedge host, see [Alternate Numeric Keypad Emulation](#).



**NOTE:** When changing USB country keyboard types the scanner automatically resets and issues the standard startup beep sequences.

For best results when using international keyboards, enable [USB Keyboard Emulation](#).



**IMPORTANT:** Some country keyboard barcode types are specific to certain Windows operating systems (i.e., XP and Windows 7 or higher). Barcodes requiring a specific Windows OS are noted in the barcode captions.

Use the French International barcode for Belgian French keyboards.

## Country Code Barcodes



\*US English (North American)



US English (Mac)

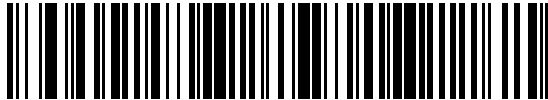

Albanian



Arabic (101)

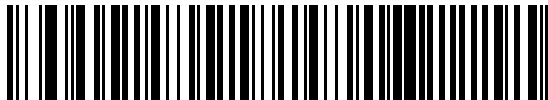

Arabic (102)



Arabic (102) AZERTY



Azeri (Latin)



Azeri (Cyrillic)



Belarusian

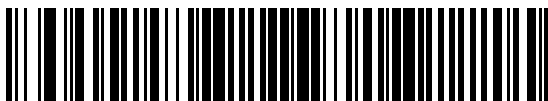

Bosnian (Latin)



Bosnian (Cyrillic)



## Country Codes

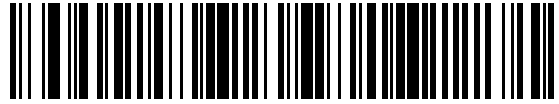

Bulgarian (Latin)

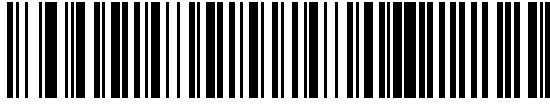

Bulgarian Cyrillic (Typewriter) (Bulgarian -Windows XP Typewriter - Windows 7 or higher)

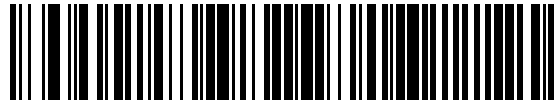

Canadian French Win7

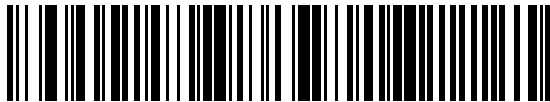

Canadian French (Legacy)

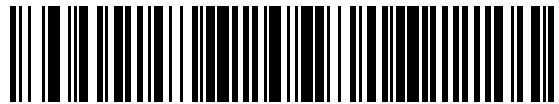

Canadian Multilingual Standard



Chinese (ASCII)



Chinese (Simplified)\*

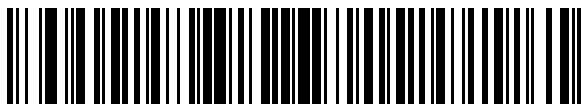

Chinese (Traditional)\*

\*For CJK keyboard types, see [CJK Decode Control](#).

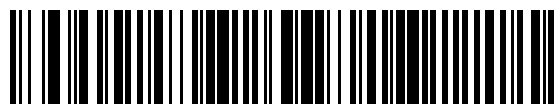

Croatian

## Country Codes



Czech



Czech (Programmer)



Czech (QWERTY)



Danish



Dutch (Netherlands)



Estonian



Faeroese

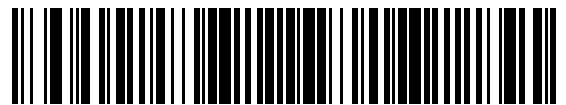

Finnish



French (France)

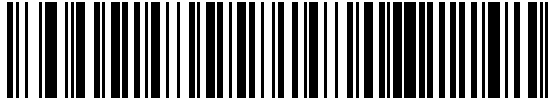

French (Canada) 95/98



French International (Belgian French)

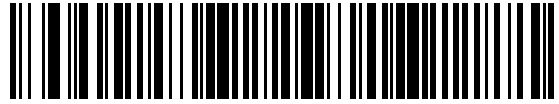

French (Canada) 2000/XP\*

\*Note that there is also a country code barcode for Canadian Multilingual Standard. Be sure to select the appropriate barcode for your host system.



Galician



German

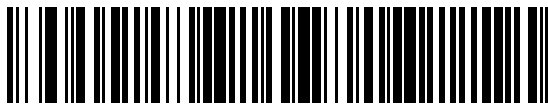

Greek Latin

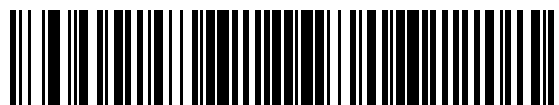

Greek (220) Latin

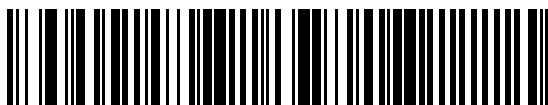

Greek (319) Latin



Greek

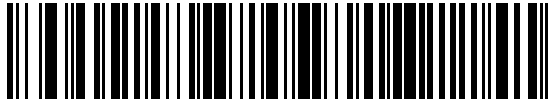

Greek (220)

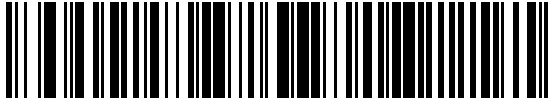

Greek (319)

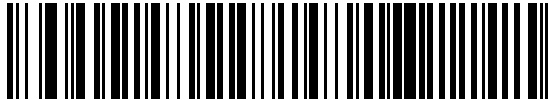

Greek Polytonic



Hebrew Israel

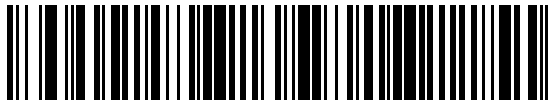

Hungarian



Hungarian\_101KEY



Icelandic



Irish



Italian

## Country Codes

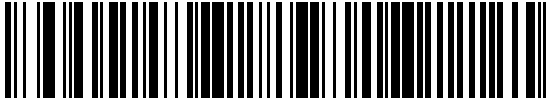

Japanese (ASCII)

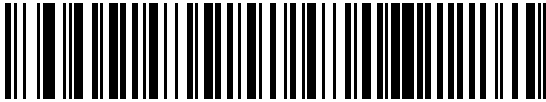

Kazakh

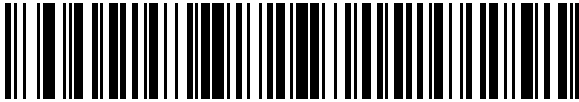

Korean (Hangul)\*

\*For CJK keyboard types, see [CJK Decode Control](#).

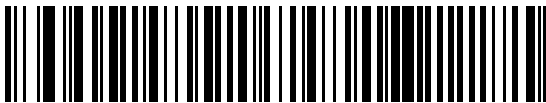

Latin American



Italian (142)

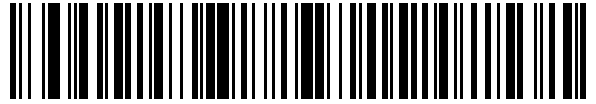

Japanese (SHIFT-JIS)\*

\*For CJK keyboard types, see [CJK Decode Control](#).

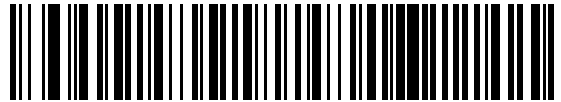

Korean (ASCII)

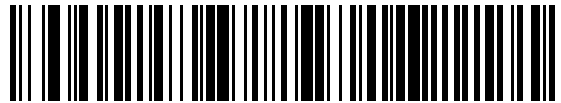

Kyrgyz



Latvian

Country Codes

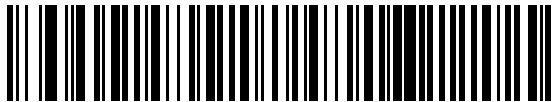

Latvian (QWERTY)

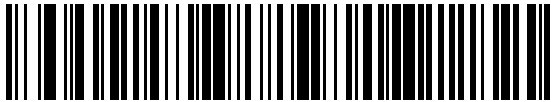

Lithuanian

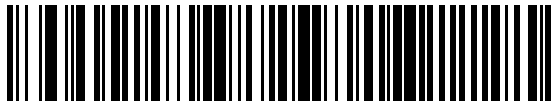

Lithuanian (IBM)



Macedonian (FYROM)



Maltese\_47KEY

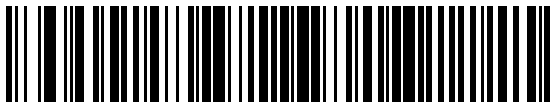

Mongolian



Norwegian

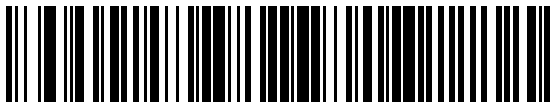

Polish (214)



Polish (Programmer)

## Country Codes



Portuguese (Brazilian ABNT)

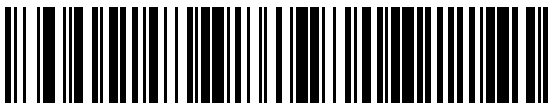

Portuguese (Portugal)

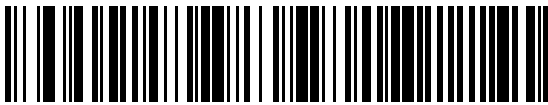

Romanian (Legacy) (Windows 7 or higher)

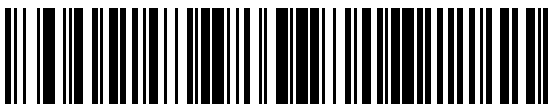

Romanian (Programmer) (Windows 7 or higher)



Russian (Typewriter)



Portuguese (Brazil) (Windows XP)

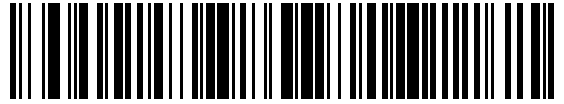

Portuguese (Brazilian ABNT2)



Romanian (Windows XP)

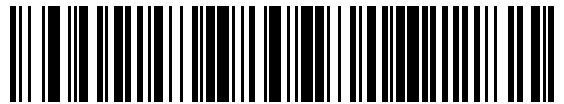

Romanian (Standard) (Windows 7 or higher)

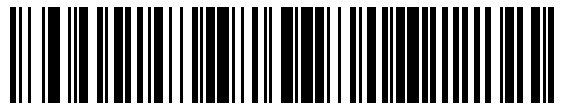

Russian

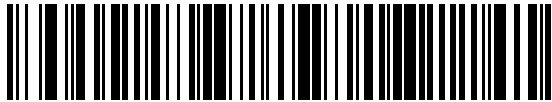

Serbian (Cyrillic)

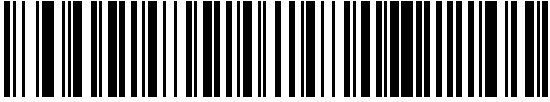

Serbian (Latin)

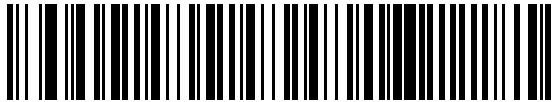

Slovak (QWERTY)



Slovak

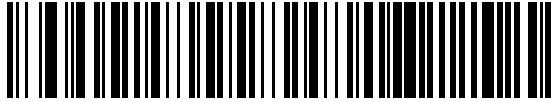

Spanish



Slovenian



Swedish



Spanish (Variation)

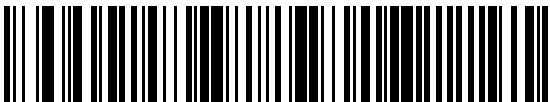

Swiss French



## Country Codes

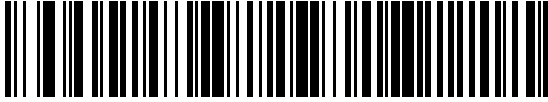

Swiss German



Tatar

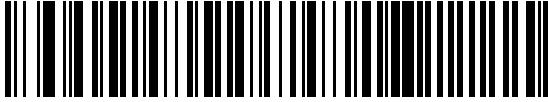

Thai (Kedmanee)

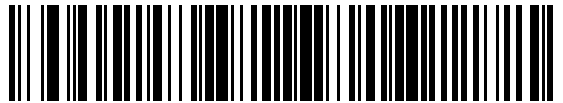

Turkish F

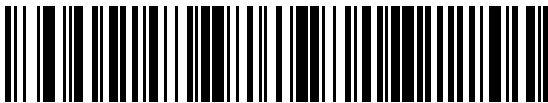

Turkish Q

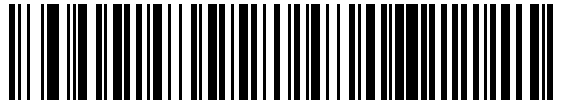

UK English

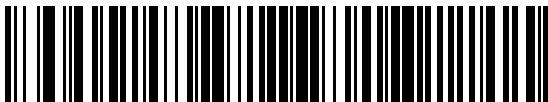

Ukrainian

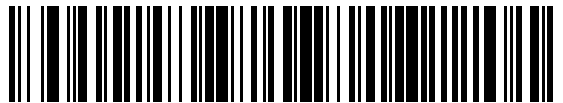

US Dvorak

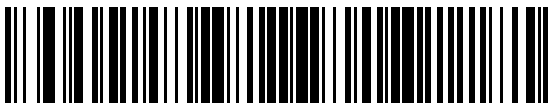

US Dvorak Left

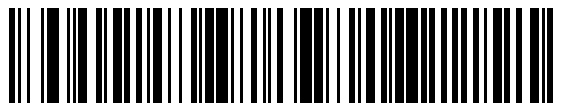

US Dvorak Right

## Country Codes

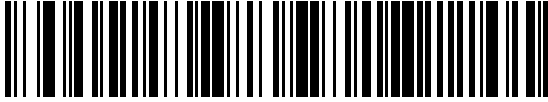

US International



Uzbek

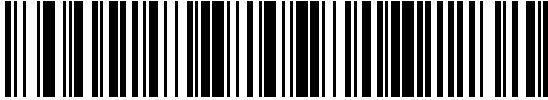

Vietnamese

# Country Code Pages

This section provides barcodes for selecting code pages for the country keyboard type selected in Country Codes.

If the default code page in [Country Code Pages](#) is appropriate for your selected country keyboard type, you do not need to scan a country code page barcode.



**NOTE:** ADF rules can also specify a code page based on the symbology and other ADF criteria. Refer to the Advanced Data Formatting Programmer Guide.

## Country Code Page Defaults

The table in this section lists the code page default for each country keyboard.

**Table 41** Country Code Page Defaults

Country Keyboard	Code Page Default
US English (North American)	Windows 1252
US English (Mac)	Mac CP10000
Albanian	Windows 1250
Arabic 101	Windows 1256
Arabic 102	Windows 1256
Arabic 102 AZERTY	Windows 1256
Azeri Latin	Windows 1254
Azeri Cyrillic	Windows 1251
Belarusian	Windows 1251
Bosnian Latin	Windows 1250
Bosnian Cyrillic	Windows 1251
Bulgarian Latin	Windows 1250
Bulgarian Cyrillic	Windows 1251
Canadian French Win7	Windows 1252
Canadian French (Legacy)	Windows 1252
Canadian Multilingual	Windows 1252

**Table 41** Country Code Page Defaults (Continued)

Country Keyboard	Code Page Default
Croatian	Windows 1250
Chinese ASCII	Windows 1252
Chinese (Simplified)	Windows 936, GBK
Chinese (Traditional)	Windows 950, Big5
Czech	Windows 1250
Czech Programmers	Windows 1250
Czech QWERTY	Windows 1250
Danish	Windows 1252
Dutch Netherland	Windows 1252
Estonian	Windows 1257
Faeroese	Windows 1252
Finnish	Windows 1252
French (France)	Windows 1252
French (Canada) 95/98	Windows 1252
French (Canada) 2000/XP	Windows 1252
French International (Belgian French)	Windows 1252
Galician	Windows 1252
German	Windows 1252
Greek Latin	Windows 1252
Greek220 Latin	Windows 1253
Greek319 Latin	Windows 1252
Greek	Windows 1253
Greek220	Windows 1253
Greek319	Windows 1253
Greek Polytonic	Windows 1253
Hebrew Israel	Windows 1255
Hungarian	Windows 1250
Hungarian_101KEY	Windows 1250
Icelandic	Windows 1252
Irish	Windows 1252
Italian	Windows 1252
Italian_142	Windows 1252
Japanese ASCII	Windows 1252

**Table 41** Country Code Page Defaults (Continued)

Country Keyboard	Code Page Default
Japanese (Shift-JIS)	Windows 932, Shift-JIS
Kazakh	Windows 1251
Korean ASCII	Windows 1252
Korean (Hangul)	Windows 949, Hangul
Kyrgyz Cyrillic	Windows 1251
Latin America	Windows 1252
Latvian	Windows 1257
Latvian QWERTY	Windows 1257
Lithuanian	Windows 1257
Lithuanian_IBM	Windows 1257
Macedonian -FYROM	Windows 1251
Maltese_47KEY	Windows 1252
Mongolian-Cyrillic	Windows 1251
Norwegian	Windows 1252
Polish_214	Windows 1250
Polish Programmer	Windows 1250
Portuguese Brazil	Windows 1252
Portuguese Brazilian ABNT	Windows 1252
Portuguese Brazilian ABNT2	Windows 1252
Portuguese Portugal	Windows 1252
Romanian	Windows 1250
Romanian Legacy	Windows 1250
Romanian Standard	Windows 1250
Romanian Programmer	Windows 1250
Russian	Windows 1251
Russian Typewriter	Windows 1251
Serbian Latin	Windows 1250
Serbian Cyrillic	Windows 1251
Slovak	Windows 1250
Slovak QWERTY	Windows 1250
Slovenian	Windows 1250
Spanish	Windows 1252
Spanish Variation	Windows 1252

**Table 41** Country Code Page Defaults (Continued)

Country Keyboard	Code Page Default
Swedish	Windows 1252
Swiss French	Windows 1252
Swiss German	Windows 1252
Tatar	Windows 1251
Thai-Kedmanee	Windows 874
Turkish F	Windows 1254
Turkish Q	Windows 1254
Ukrainian	Windows 1251
United Kingdom	Windows 1252
United States	Windows 1252
US Dvorak	Windows 1252
US Dvorak Left Hand	Windows 1252
US Dvorak Right Hand	Windows 1252
US International	Windows 1252
Uzbek Cyrillic	Windows 1251
Vietnamese	Windows 1258

## Country Code Page Barcodes

### Parameter # 961

Scan the barcode corresponding to the country keyboard code page.

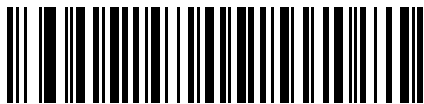

Windows 1250 Latin 2, Central European

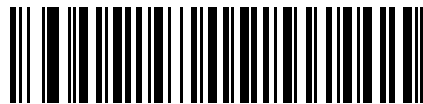

Windows 1251 Cyrillic, Slavic



Windows 1252 Latin 1, Western European



Windows 1254 Latin 5, Turkish

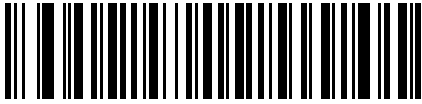

Windows 1256 Arabic

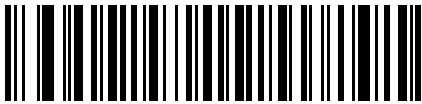

Windows 1258 Vietnamese

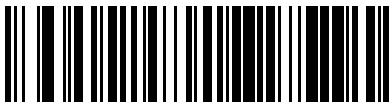

Windows 20866 Cyrillic KOI8-R



Windows 1253 Greek

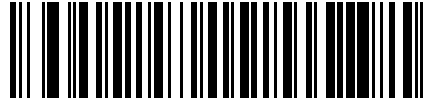

Windows 1255 Hebrew

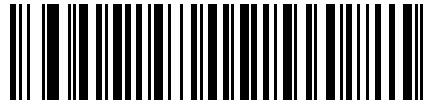

Windows 1257 Baltic

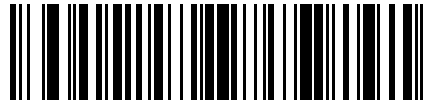

Windows 874 Thai

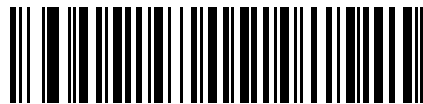

Windows 932 Japanese Shift-JIS



Windows 936 Simplified Chinese GBK



Windows 54936 Simplified Chinese GB18030

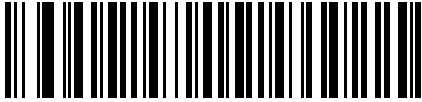

Windows 949 Korean Hangul

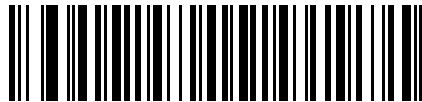

Windows 950 Traditional Chinese Big5

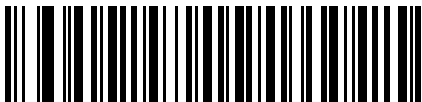

MS-DOS 437 Latin US

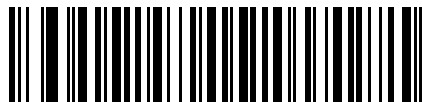

MS-DOS 737 Greek

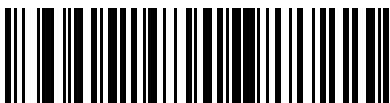

MS-DOS 775 Baltic

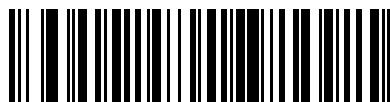

MS-DOS 850 Latin 1



MS-DOS 852 Latin 2





MS-DOS 857 Turkish

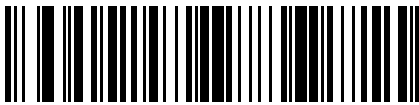

MS-DOS 861 Icelandic

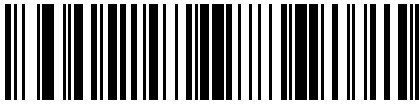

MS-DOS 863 French Canada

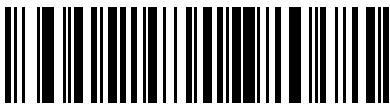

MS-DOS 866 Cyrillic



MS-DOS 855 Cyrillic

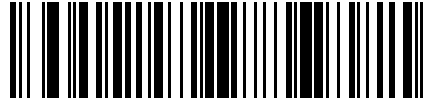

MS-DOS 860 Portuguese

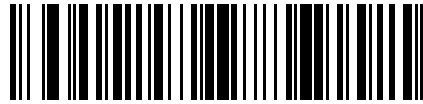

MS-DOS 862 Hebrew

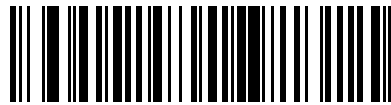

MS-DOS 865 Nordic

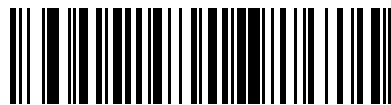

MS-DOS 869 Greek 2

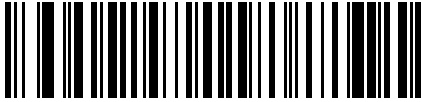

ISO 8859-1 Latin 1, Western European



ISO 8859-2 Latin 2, Central European



ISO 8859-3 Latin 3, South European

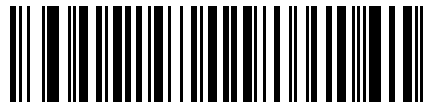

ISO 8859-4 Latin 4, North European

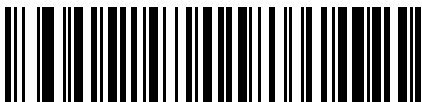

ISO 8859-5 Cyrillic

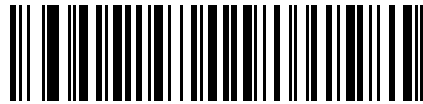

ISO 8859-6 Arabic

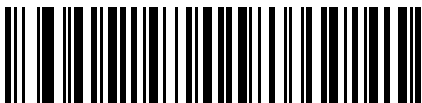

ISO 8859-7 Greek

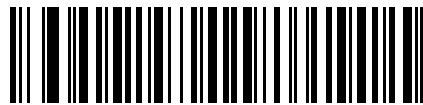

ISO 8859-8 Hebrew



ISO 8859-9 Latin 5, Turkish



ISO 8859-10 Latin 6, Nordic



ISO 8859-11 Thai



ISO 8859-13 Latin 7, Baltic

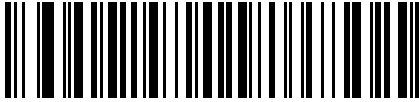

ISO 8859-14 Latin 8, Celtic

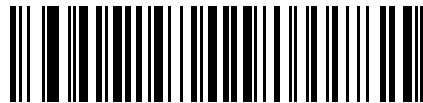

ISO 8859-15 Latin 9

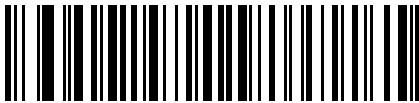

ISO 8859-16 Latin 10, South-Eastern European

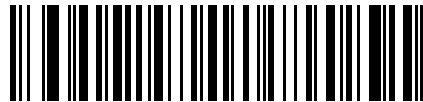

UTF-8



UTF-16LE UTF-16 Little Endian



UTF-16BE UTF-16 Big Endian



Mac CP10000 Roman

# CJK Decode Control

This appendix describes control parameters for CJK (Chinese, Japanese, Korean) barcode decode through USB HID Keyboard Emulation mode.



**NOTE:** Because ADF does not support CJK character processing, there is no format manipulation for CJK output.

## CJK Control Parameters

### Unicode Output Control

#### Parameter # 973

For a Unicode encoded CJK barcode, select one of the following options for Unicode output:

- Universal Output to Unicode and MBCS Application - This default method applies to Unicode and MBCS expected applications, such as MS Word and Notepad on a Windows host.



**NOTE:** To support Unicode universal output, set up the registry table for the Windows host. See [Unicode/CJD Decode Setup with Windows Host](#).

- Output to Unicode Application Only - This method applies only to Unicode expected applications, such as MS Word and WordPad, but not Notepad.

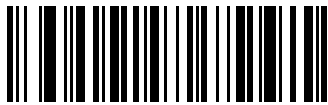

\*Universal Output (0)

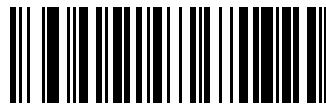

Unicode Application Only (1)

### CJK Output Method to Windows Host

#### Parameter # 972

For a national standard encoded CJK barcode, select one of the following options for CJK output to a Windows host:

- **Universal CJK Output** - This is the default universal CJK output method for US English IME or Chinese/Japanese/Korean ASCII IME on a Windows host. This method converts CJK characters to Unicode and emulates the characters when transmitting to the host. Use the [Unicode Output Control](#) parameter to control Unicode output.



**NOTE:** To support universal CJK output, set up the registry table for the Windows host. See [Unicode/CJK Decode Setup Windows Host](#).

- **Other options for CJK output** - With the following methods, the scanner sends the CJK character hexadecimal internal code (Nei Ma) value to the host, or converts the CJK character to Unicode and sends the hexadecimal Unicode value to the host. When using these methods, the Windows host must select the corresponding IME to accept the CJK character. See [Unicode/CJK Decode Setup Windows Host](#).
- **Japanese Unicode Output**
- **Simplified Chinese GBK Code Output**
- **Simplified Chinese Unicode Output**
- **Korean Unicode Code Output**
- **Traditional Chinese Big5 Code Output** (Windows XP)
- **Traditional Chinese Big5 Code Output** (Windows 7)
- **Traditional Chinese Unicode Code Output** (Windows XP)
- **Traditional Chinese Unicode Code Output** (Windows 7)



**NOTE:** The Unicode emulate output method depends on the host system (Windows XP or Windows 7).

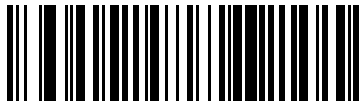

\*Universal CJK Output (0)

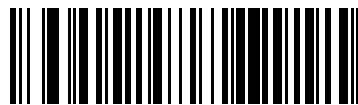

Japanese Unicode Output (34)

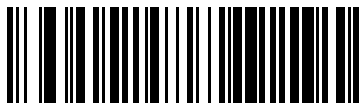

Chinese (Simplified) GBK Output (1)

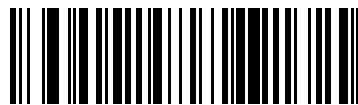

Chinese (Simplified) Unicode Output (2)

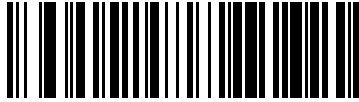

Korean Unicode Output (50)

(for Korean Unicode Output, select Simplified Chinese Unicode IME on the Windows host)



Chinese (Traditional) Big5 Output (Windows XP) (1)

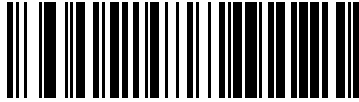

Chinese (Traditional) Big5 Output (Windows 7) (19)



Chinese (Traditional) Unicode Output (Windows XP) (18)

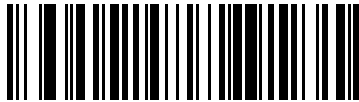

Chinese (Traditional) Unicode Output (Windows 7) (20)

## Non-CJK UTF Barcode Output

### Parameter # 960

Some country keyboard type layouts contain characters that do not exist in the default code page (see below). Although the default code page can not encode these characters in a barcode, they can be encoded in the UTF-8 barcode. Scan the following barcode to output the Unicode values by emulation mode.



**NOTE:** Use this special country keyboard type to decode the non-CJK UTF-8 barcode. After decoding, re-configure the scanner to use the original country keyboard type.

Use US English IME on Windows. See [Unicode Output Control](#).



Non-CJK UTF-8 Emulation Output

**Missing Characters for Country Keyboard Type: Tatar, Uzbek, Mongolian, Kyrgyz, Kazakh and Azeri**

Default code page: CP1251

Missing characters:

F	F
X	X
K	K
h	h
ø	Ø
ə	Ə
Y	Y
H	H
Ж	Ж
ƒ	
H	H
Ÿ	Ÿ
K	K
ч	ч
к	к

#### Missing Characters for Country Keyboard Type: Romanian (Standard)

Default code page: CP1250

Missing characters:

ș	Ș
ț	Ț

#### Missing Characters for Country Keyboard Type: Portuguese-Brazilian (ABNT), Portuguese-Brazilian (ABNT2)

Default code page: CP1252

Missing character: €

#### Missing Characters for Country Keyboard Type: Azeri-Latin

Default code page: CP1254

Missing characters: ə, Ə

## Unicode/CJK Decode Setup with Windows Host

This section describes how to set up CJK decode with a Windows host.

### Setting Up the Windows Registry Table for Unicode Universal Output

To support the Unicode universal output method, set up the Windows host registry table as follows:

1. Select **Start > Run > regedt32** to start the registry editor.

- Under **HKEY\_Current\_User\Control Panel\Input Method**, set **EnableHexNumpad** to **1** as follows:

```
[HKEY_CURRENT_USER\Control Panel\Input Method]
```

```
"EnableHexNumpad" = "1"
```

If this key does not exist, add it as type **REG\_SZ** (string value).

- Reboot the computer to implement the registry change.

## Adding CJK IME on Windows

To add the desired CJK input language:

- Click **Start > Control Panel**.
- If the Control Panel opens in category view, select **Switch to Classic View** in the top left corner.
- Select **Regional and Language Options**.
- Click the **Language** tab.
- Under **Supplemental Language Support**, select the **Install Files for East Asian Languages** check box if not already selected, and click **Apply**. This may require a Windows installation CD to install the required files. This step ensures that the East Asian Languages (CJK) are available.
- Under **Text Services and Input Language**, click **Details**.
- Under **Installed Services**, click **Add**.
- In the **Add Input Language** dialog box, choose the CJK input language and keyboard layout or Input Method Editor (IME) to add.
- Click **OK** twice. The language indicator appears in the system tray (at bottom right corner of the desktop by default). To switch between input languages (keyboard languages) select the language indicator in the system tray.
- Select the language indicator in the system tray to select the desired country keyboard type.
- Verify that the characters displayed on each country's keyboard appear.

## Selecting the Simplified Chinese Input Method on the Host

To select the Simplified Chinese input method:

- Select Unicode/GBK input on Windows XP: **Chinese (Simplified) - NeiMa**, then click the input bar to select **Unicode** or **GBK NeiMa** input.

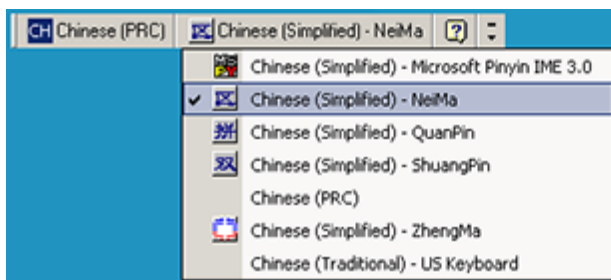

Or





- Select Unicode/GBK input on Windows 7: **Chinese (Simplified) - Microsoft Pinyin New Experience Input Style**, then select **Tool Menu > Secondary Inputs > Unicode Input** or **GB Code Input**.

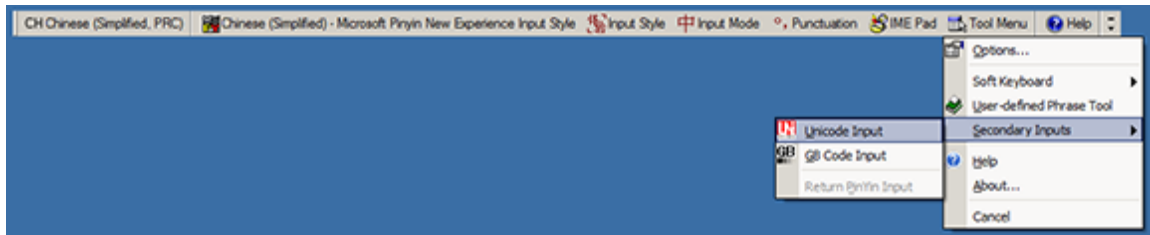

## Selecting the Traditional Chinese Input Method on the Host

To select the Traditional Chinese input method:

- Select Unicode input on Windows XP: **Chinese (Traditional) - Unicode**

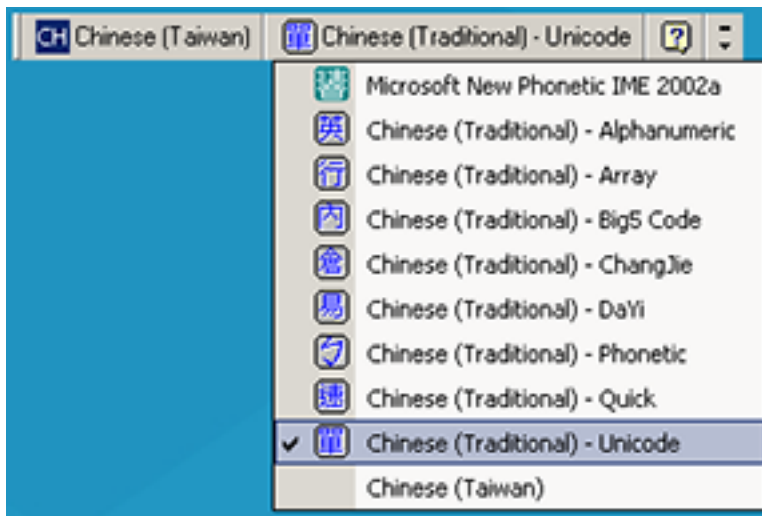

- Select Big5 input on Windows XP: **Chinese (Traditional) - Big5 Code**

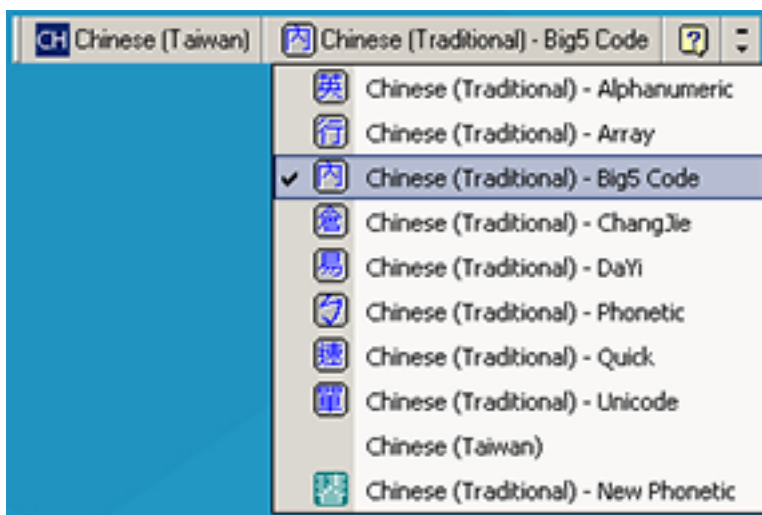

- Select Unicode/Big5 input on Windows 7: **Chinese (Traditional) - New Quick**. This option support both Unicode and Big5 input.

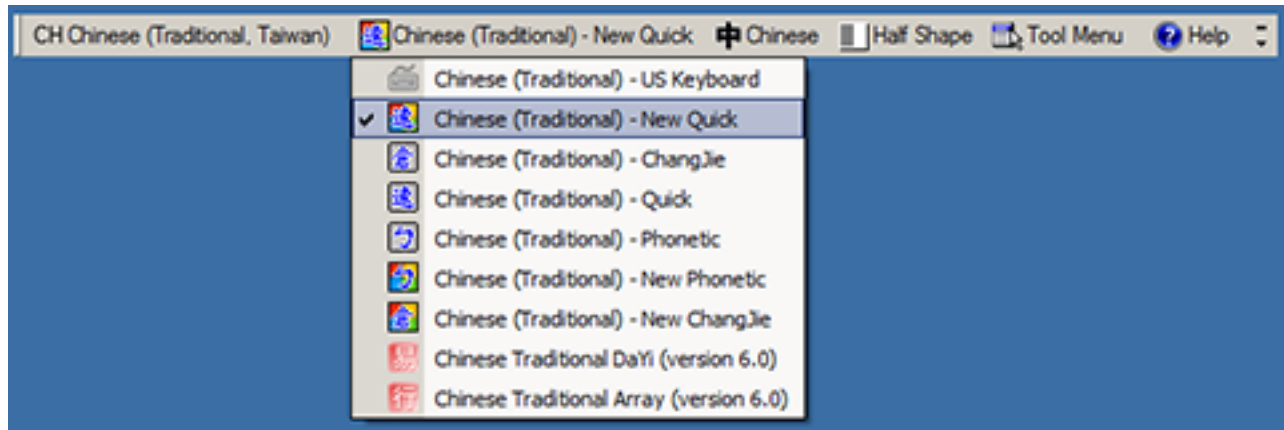

# Non-Parameter Attributes

This section defines the scanner's non-parameter attributes.

## Model Number

Attribute #533

number of the scanner. This electronic output matches the printout on the physical device label.

Type	S
Size (Bytes)	18
User Mode Access	R
Values	Variable

## Serial Number

Attribute #534

Unique serial number assigned in the manufacturing facility. This electronic output matches the printout on the physical device label, for example M1J26F45V.

Type	S
Size (Bytes)	16
User Mode Access	R
Values	Variable

## Date of Manufacture

Attribute #535

Date of device manufacture assigned in the manufacturing facility. This electronic output matches the printout on the physical device label, for example 30APR24 (which reads the 30th of April 2024).

Type	S
Size (Bytes)	7
User Mode Access	R

Values	Variable
--------	----------

## Date of First Programming

Attribute #614

Date of first electronic programming represents the first time settings were electronically loaded to the scanner either by 123Scan or via SMS, for example 18MAY24 (which reads the 18th of May 2024).

Type	S
Size (Bytes)	7
User Mode Access	R
Values	Variable

## Configuration Filename

Attribute #616

The name assigned to the configuration settings loaded electronically to the device either by 123Scan or via SMS.



**NOTE:** Scanning the Set Defaults barcode automatically changes the configuration filename to factory defaults.

To indicate the configuration settings loaded to the device were changed, the configuration filename changes to Modified upon scanning any parameter barcode.

Type	S
Size (Bytes)	17
User Mode Access	RW
Values	Variable

## Beeper/LED

Attribute #6000

Activates the beeper and/or LED.

Type	X
Size (Bytes)	N/A
User Mode Access	W
Values	See <a href="#">Beeper/LED Values</a>

**Table 42** Beeper/LED Values

Beep / LED Action	Value	Beep / LED Action	Value
1 high short beep	0	1 low long beep	15

**Table 42** Beeper/LED Values (Continued)

Beep / LED Action	Value	Beep / LED Action	Value
2 high short beeps	1	2 low long beeps	16
3 high short beeps	2	3 low long beeps	17
4 high short beeps	3	4 low long beeps	18
5 high short beeps	4	5 low long beeps	19
1 low short beep	5	Fast warble beep	20
2 low short beeps	6	Slow warble beep	21
3 low short beeps	7	High-low beep	22
4 low short beeps	8	Low-high beep	23
5 low short beeps	9	High-low-high beep	24
1 high long beep	10	Low-high-low beep	25
2 high long beeps	11	High-high-low-low beep	26
3 high long beeps	12	Green LED off	42
4 high long beeps	13	Green LED on	43
5 high long beeps	14	Red LED on	47
		Red LED off	48

## Parameter Defaults

Attribute #6001

This attribute restores all parameters to their factory defaults.

Type	X
Size (Bytes)	N/A
User Mode Access	W
Values	0 = Restore Defaults 1 = Restore Factory Defaults 2 = Write Custom Defaults

## Beep on Next Bootup

Attribute #6003

This attribute configures (enables or disables) beep on next boot up of scanner.

Type	X
Size (Bytes)	N/A
User Mode Access	W
Values	0 = Disable beep on next bootup 1 = Enable beep on next bootup

## Reboot

Attribute #6004

This attribute initiates a device reboot.

Type	X
Size (Bytes)	N/A
User Mode Access	W
Values	N/A

## Host Trigger Session

Attribute #6005

This attribute triggers a decode session similar to manually depressing the scanner trigger button.

Type	X
Size (Bytes)	N/A
User Mode Access	W
Values	1 = Start Host Trigger Session 0 = Stop Host Trigger Session

## Firmware Version

Attribute #20004

The scanner's operating system version. For example, PAAAABS00-007-R03D0.

Type	S
Size (Bytes)	Variable
User Mode Access	R
Values	Variable

## Scankit Version

Attribute #20008

Identifies the 1D decode algorithms resident on the device, for example SKIT4.33T02.

Type	S
Size (Bytes)	Variable
User Mode Access	R
Values	Variable

# Sample Barcodes

This section provides sample barcodes.

## Sample Code 39



## Sample Code 93

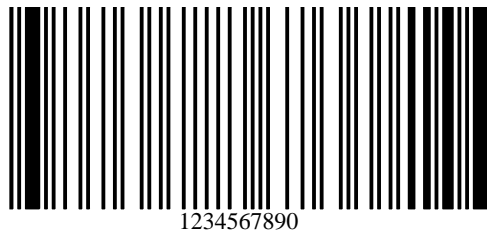

## Sample UPC/EAN

UPC-A, 100%



UPC-A Plus 2



# Sample Barcodes

**UPC-A Plus 5**



**UPC-E**



**UPC-E Plus 2**



**UPC-E Plus 5**



**EAN-8**



**EAN-13, 100%**

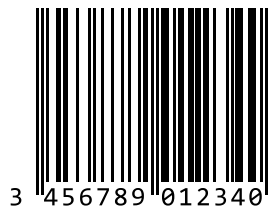



**EAN-13 Plus 2**



**EAN-13 Plus 5**



**Sample Code 128**



**Sample Interleaved 2 of 5**



**Sample Chinese 2 of 5**



## Sample Matrix 2 of 5



## Sample Korean 3 of 5



## Sample GS1 DataBar

### GS1 DataBar Omnidirectional



**NOTE:** GS1 DataBar Omnidirectional must be enabled to read the following barcode (see [GS1 DataBar Omnidirectional \(formerly GS1 DataBar-14\)](#)).



### GS1 DataBar Limited



**NOTE:** DataDataBar Limited must be enabled to read the following barcode (see [GS1 DataBar Limited](#)).



### GS1 DataBar Expanded



**NOTE:** DataBar Expanded must be enabled to read the following barcode (see [GS1 DataBar Expanded](#)).

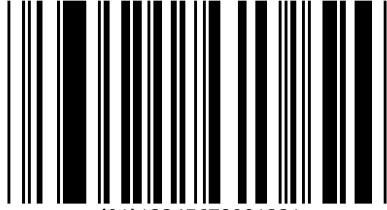

(01)12345678901231

### Sample PDF417

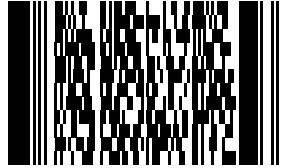

### Sample Data Matrix

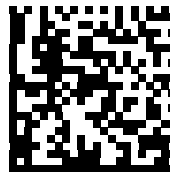

123456789abcdefghijklmnopqrstuvwxy

### Sample Maxicode

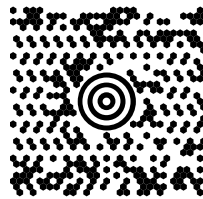

### Sample QR Code



0123456789ABCDEFGHIJKLMNOPQRSTUVWXYZ0123456789ABCDEFGHIJKLMNOPQRSTUVWXYZ012345  
6789

## Sample Aztec



0123456789ABCDEFGHIJKLMNQRSTUUVWXYZ0123456789ABCDEFGHIJKLMNQRSTUUV  
WXYZ01234567890123456789ABCDEFGHIJKLMNQRSTUUVWXYZ0123456789ABCDEFGHI  
JKLMNQRSTUUVWXYZ0123456789

## Sample Grid Matrix



**NOTE:** Grid Matrix must be enabled to read the following bar code (see [Grid Matrix](#)).

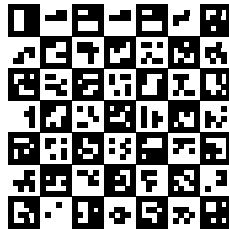

## Postal Codes

### Sample US Postnet



### Sample UK Postal



